

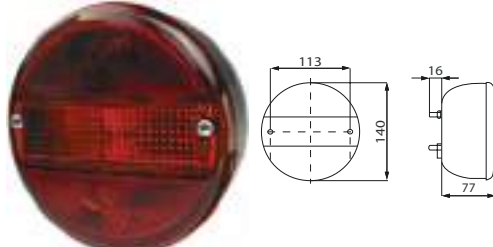
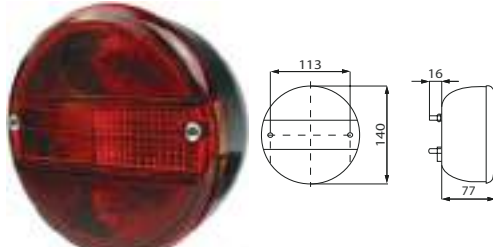

EL. SPECIFICATIONS	DIMENSIONS	ADDITIONAL SPECIFICATIONS
<b>171322 Lens, Rear Lamp</b> Servicing: HC-CARGO 171802, 171803		
		Dim.: 516x130 mm Dist. mount. holes: 152 mm Shape: Rectangular
<b>171328 Multi Function Lamp</b>		
<i>Lens: HC-CARGO 171330.</i>		
	Bulb incl.: No Watt: 21 Watt 2: 5 Dim.: 140x77 mm OD: 140 mm Dist. mount. holes: 45 mm	Socket type: BA15S Socket type 2: BA15S Material: Shockproof plastic Shape: Circular Fixing screw: 2 Flasher light: w/ Numberplate light: w/ Tail light: w/ Stop light: w/ E-approval: Yes
<b>171329 Multi Function Lamp</b>		
<i>Mounting kit: HC-CARGO 171266. Lens: HC-CARGO 171330.</i>		
	Bulb incl.: No Dim.: 140x77 mm OD: 140 mm Dist. mount. holes: 45 mm	Socket type: BA15S Material: Shockproof plastic Shape: Circular Fixing screw: 2 Flasher light: w/ Tail light: w/ Stop light: w/ E-approval: Yes
<b>171330 Lens, Rear Lamp</b> Servicing: HC-CARGO 171328, 171329		
		OD: 140 mm Shape: Circular RH/LH: RH/LH
<b>171372 Multi Connector</b> Servicing: HC-CARGO 171050, 171051, 171052, 171053, 171054, 171055, 171818, 171821		
<i>Socket w/ quick connection.</i>		
		Dim.: 62x26.5 mm Colour/glass: Yellow RH/LH: LH E-approval: Yes
<b>171373 Multi Connector</b> Servicing: HC-CARGO 171050, 171051, 171052, 171053, 171054, 171055, 171818, 171821		
<i>Socket w/ quick connection.</i>		
		Dim.: 62x26.5 mm Colour/glass: Green RH/LH: RH E-approval: Yes

**171441 Multi Function Lamp**

Servicing: Commercial trailers

Right: HC-CARGO 171442. Lens: HC-CARGO 171446.

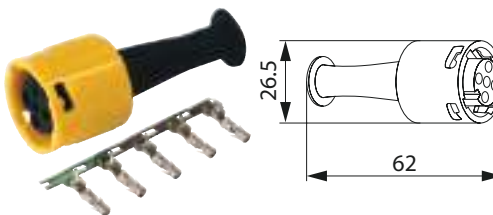
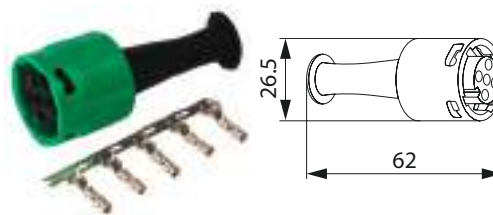
 Bulb incl.: No  
 Watt: 21  
 Watt 2: 20/5  
 Watt 3: 10

 Dim.: 421x147x75 mm  
 Dist. mount. holes:  
 152 mm

 Socket type: BA15S  
 Socket type 2: BAY15d  
 Socket type 3: BA10s  
 Material: Shockproof plastic  
 Shape: Rectangular  
 Reflector: w/  
 Flasher light: w/  
 Numberplate light: w/  
 Tail light: w/  
 Stop light: w/  
 RH/LH: LH  
 E-approval: Yes

**171442 Multi Function Lamp**

Servicing: Commercial trailers

Lens: HC-CARGO 171446. Left: HC-CARGO 170602. Lens: HC-CARGO 171441.

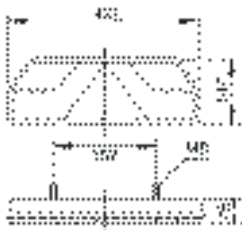
 Bulb incl.: No  
 Watt: 21  
 Watt 2: 21/5  
 Watt 3: 5  
 Watt 4: 10

 Dim.: 421x147x75 mm  
 Dist. mount. holes:  
 152 mm

 Socket type: BA15S  
 Socket type 2: BAY15d  
 Socket type 3: BA15S  
 Socket type 4: BA10s  
 Material: Shockproof plastic  
 Shape: Rectangular  
 Reflector: w/  
 Flasher light: w/  
 Numberplate light: w/  
 Rear/fog lamp: w/  
 Sidemarker lamp: w/  
 Tail light: w/  
 Stop light: w/  
 RH/LH: RH  
 E-approval: Yes

**171443 Multi Function Lamp**

Servicing: Schwarzmüller

Right: HC-CARGO 171444. Lens: HC-CARGO 171446.

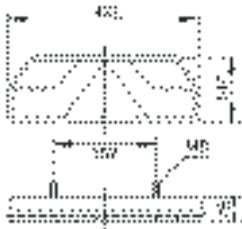
 Bulb incl.: No  
 Watt: 21  
 Watt 2: 21/5  
 Watt 3: 5  
 Watt 4: 10

 Dim.: 421x147x75 mm  
 Dist. mount. holes:  
 152 mm

 Socket type: BA15S  
 Socket type 2: BAY15d  
 Socket type 3: BA15S  
 Socket type 4: BA10s  
 Material: Shockproof plastic  
 Shape: Rectangular  
 Reflector: w/  
 Flasher light: w/  
 Numberplate light: w/  
 Rear/fog lamp: w/  
 Sidemarker lamp: w/  
 Tail light: w/  
 Stop light: w/  
 RH/LH: LH  
 E-approval: Yes

**171444 Multi Function Lamp**

Servicing: Schwarzmüller

Lens: HC-CARGO 171446. Left: HC-CARGO 170602. Lens: HC-CARGO 171443.

 Bulb incl.: No  
 Watt: 21  
 Watt 2: 21/5  
 Watt 3: 5  
 Watt 4: 10

 Dim.: 421x147x75 mm  
 Dist. mount. holes:  
 152 mm

 Socket type: BA15S  
 Socket type 2: BAY15d  
 Socket type 3: BA15S  
 Socket type 4: BA10s  
 Material: Shockproof plastic  
 Shape: Rectangular  
 Reflector: w/  
 Flasher light: w/  
 Numberplate light: w/  
 Rear/fog lamp: w/  
 Sidemarker lamp: w/  
 Tail light: w/  
 Stop light: w/  
 RH/LH: RH  
 E-approval: Yes







**171446 Lens, Rear Lamp**





Servicing: HC-CARGO 171443, 171444

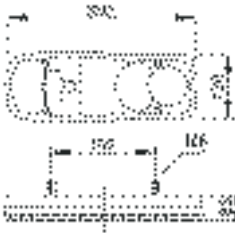

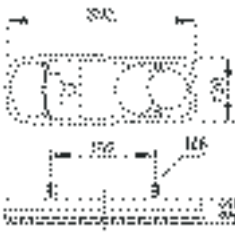

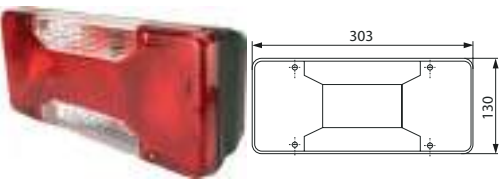
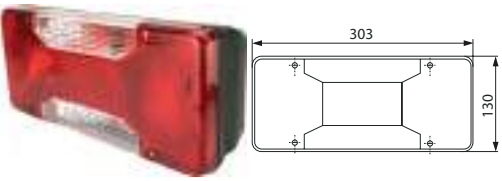

Dim.: 421x147 mm

 Shape: Rectangular  
 Reflector: w/  
 Numberplate light: w/

171447 Multi Function Lamp		Servicing: Mercedes Actros SK	
<i>Right: HC-CARGO 171448. Lens: HC-CARGO 171521.</i>			
 	Bulb incl.: No Watt: 21 Watt 2: 5 Watt 3: 10	Dim.: 525x139x83 mm Dist. mount. holes: 200 mm	Socket type: BA15S Socket type 2: BA15S Socket type 3: BA15S Material: Shockproof plastic Shape: Rectangular <b>Reflector:</b> w/ Flasher light: w/ Numberplate light: w/ Rear/fog lamp: w/ Reverse light: w/ Sidemarker lamp: w/ Tail light: w/ Stop light: w/ RH/LH: LH E-approval: Yes
	<b>171448 Multi Function Lamp</b> Servicing: Mercedes Actros SK <i>Lens: HC-CARGO 171312. Left: HC-CARGO 170602. Lens: HC-CARGO 171447.</i>		
 	Bulb incl.: No Watt: 21 Watt 2: 5 Watt 3: 10	Dim.: 525x139x83 mm Dist. mount. holes: 200 mm	Socket type: BA15S Socket type 2: BA15S Socket type 3: BA15S Material: Shockproof plastic Shape: Rectangular <b>Reflector:</b> w/ Flasher light: w/ Rear/fog lamp: w/ Reverse light: w/ Sidemarker lamp: w/ Tail light: w/ Stop light: w/ RH/LH: RH E-approval: Yes
	<b>171506 Multi Function Lamp</b> Servicing: DAF, Nissan, Renault <i>2 bulb holders for tail light. Lens: HC-CARGO 171507. Multiconnector: HC-CARGO 171788, 172066.</i>		
 	Bulb incl.: No Watt: 21 Watt 2: 5 Watt 3: 10	Dim.: 350x130x85 mm Dist. mount. holes: 152 mm	Socket type: BA15S Socket type 2: BA15S Socket type 3: BA15S Material: Shockproof plastic Shape: Rectangular <b>Reflector:</b> w/ Flasher light: w/ Numberplate light: w/ Rear/fog lamp: w/ Reverse light: w/ Tail light: w/ Stop light: w/ RH/LH: RH/LH E-approval: Yes
	<b>171507 Lens, Rear Lamp</b> Servicing: HC-CARGO 171506, 171508		
		Dim.: 350x130 mm	Material: Shockproof plastic Shape: Rectangular <b>Reflector:</b> w/ Numberplate light: w/ RH/LH: RH/LH
	<b>171508 Multi Function Lamp</b> Servicing: Commercial trailers <i>Optional use. 2 bulb holders for tail light. Lens: HC-CARGO 171507.</i>		
 	Bulb incl.: No Watt: 21 Watt 2: 5 Watt 3: 10	Dim.: 350x130x85 mm Dist. mount. holes: 152 mm	Socket type: BA15S Socket type 2: BA15S Socket type 3: BA15S Material: Shockproof plastic Shape: Rectangular Flasher light: w/ Numberplate light: w/ Rear/fog lamp: w/ Reverse light: w/ Tail light: w/ Stop light: w/ RH/LH: RH/LH Approvals: CE E-approval: Yes

EL. SPECIFICATIONS		DIMENSIONS	ADDITIONAL SPECIFICATIONS
<b>171521</b> Lens, Rear Lamp 		Servicing: HC-CARGO 171311  Dim.: 525x139 mm	Shape: Rectangular Reflector: w/
<b>171537</b> Multi Connector Socket w/ quick connection. 			Colour: Red RH/LH: LH
<b>171538</b> Multi Connector Socket w/ quick connection. 			Colour: Green RH/LH: RH
<b>171700</b> Multi Function Lamp Lens: HC-CARGO 171702. Left: HC-CARGO 170602. Lens: HC-CARGO 171701.			
		Bulb incl.: No Voltage: 12/24  Dim.: 303x130x81 mm Dist. mount. holes: 190 mm	Material: Shockproof plastic Shape: Rectangular Reflector: w/ Flasher light: w/ Numberplate light: w/o Rear/fog lamp: w/ Reverse light: w/ Tail light: w/ Stop light: w/ RH/LH: RH E-approval: Yes
<b>171701</b> Multi Function Lamp Right: HC-CARGO 171700. Lens: HC-CARGO 171702.			
		Bulb incl.: No Voltage: 12/24  Dim.: 303x130x81 mm Dist. mount. holes: 190 mm	Material: Shockproof plastic Shape: Rectangular Reflector: w/ Flasher light: w/ Numberplate light: w/o Rear/fog lamp: w/ Reverse light: w/ Tail light: w/ Stop light: w/ RH/LH: LH E-approval: Yes
<b>171702</b> Lens, Rear Lamp 		Servicing: HC-CARGO 171700, 171701  Dim.: 303x130 mm	Material: Shockproof plastic Shape: Rectangular Reflector: w/ RH/LH: RH

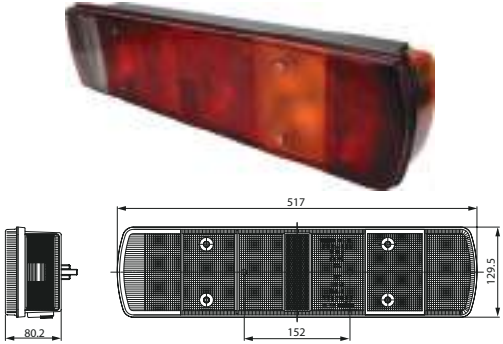

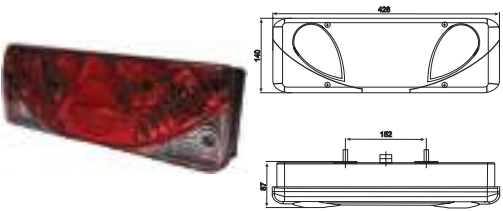
<b>171703</b> Lens, Rear Lamp		Servicing: HC-CARGO 171701	
		Dim.: 303x130 mm	Material: Shockproof plastic Shape: Rectangular Reflector: w/ RH/LH: LH
<b>171788</b> Multiconnector 7 pin		Servicing: HC-CARGO 171506, 171756, 171757, 171802, 171803, 171927, 171928, 171929, 171930, 172061, 172062, 172063, 172064	
Gasket: HC-CARGO 192178. Terminal: HC-CARGO 193250.			
			Type/terminal: Round Colour: Black No./poles: 7 Plug: Female
<b>171802</b> Multi Function Lamp		Servicing: Scania	
Left: HC-CARGO 171803. Multi plug: HC-CARGO 171788, 172066. Lens: HC-CARGO 171322.			
		Bulb incl.: No Watt: 21 Watt 2: 5	Dim.: 517x129.5x80.2 mm Dist. mount. holes: 152 mm
			Socket type: BA15S Socket type 2: BA15S Material: Shockproof plastic Shape: Rectangular Reflector: w/ Flasher light: w/ Numberplate light: w/ Rear/fog lamp: w/ Reverse light: w/ Sidemarker lamp: w/ Tail light: w/ Stop light: w/ RH/LH: RH E-approval: Yes
<b>171803</b> Multi Function Lamp		Servicing: Scania, Opel	
Right: HC-CARGO 171802. Multi plug: HC-CARGO 171788, 172066. Lens: HC-CARGO 171322.			
		Bulb incl.: No Watt: 21 Watt 2: 5	Dim.: 517x129.5x80.2 mm Dist. mount. holes: 152 mm
			Socket type: BA15S Socket type 2: BA15S Material: Shockproof plastic Shape: Rectangular Reflector: w/ Flasher light: w/ Numberplate light: w/ Rear/fog lamp: w/ Reverse light: w/ Sidemarker lamp: w/ Tail light: w/ Stop light: w/ RH/LH: LH E-approval: Yes
<b>171806</b> Multi Function Lamp		Servicing: Trucks, Universal	
Right: HC-CARGO 171807. Lens: HC-CARGO 171810.			
		Bulb incl.: No Watt: 21/5 Watt 2: 21 Watt 3: 21 Watt 4: 5	Dim.: 428x140x87 mm Dist. mount. holes: 152 mm
			Socket type: BAY15d Socket type 2: BA15S Socket type 3: BAU15s Socket type 4: BA15S Material: Shockproof plastic Shape: Rectangular Flasher light: w/ Rear/fog lamp: w/ Reverse light: w/ Sidemarker lamp: w/ Tail light: w/ Stop light: w/ RH/LH: LH E-approval: Yes

**171807 Multi Function Lamp**

Servicing: Trucks, Universal

Lens: HC-CARGO 171810. Left: HC-CARGO 170602. Lens: HC-CARGO 171806.

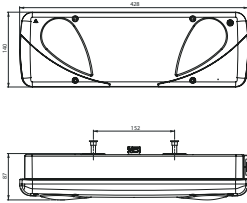

Bulb incl.: No  
Watt: 21/5  
Watt 2: 21  
Watt 3: 21  
Watt 4: 5

Dim.: 428x140x87 mm  
Dist. mount. holes:  
152 mm

Socket type: BAY15d  
Socket type 2: BA15S  
Socket type 3: BAU15s  
Socket type 4: BA15S  
Material: Shockproof plastic  
Shape: Rectangular  
Flasher light: w/  
Rear/fog lamp: w/  
Reverse light: w/  
Sidemarker lamp: w/  
Tail light: w/  
Stop light: w/  
RH/LH: RH  
E-approval: Yes

**171808 Multi Function Lamp**

Servicing: Commercial trailers

Right: HC-CARGO 171809. Lens: HC-CARGO 171810.

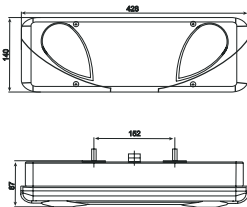

Bulb incl.: No  
Watt: 21/5  
Watt 2: 21  
Watt 3: 21  
Watt 4: 5

Dim.: 428x140x87 mm  
Dist. mount. holes:  
152 mm

Socket type: BAY15d  
Socket type 2: BA15S  
Socket type 3: BAU15s  
Socket type 4: BA15S  
Material: Shockproof plastic  
Shape: Rectangular  
Reflector: w/  
Flasher light: w/  
Rear/fog lamp: w/  
Reverse light: w/  
Sidemarker lamp: w/  
Tail light: w/  
Stop light: w/  
RH/LH: LH  
E-approval: Yes

**171809 Multi Function Lamp**

Servicing: Commercial trailers

Lens: HC-CARGO 171810. Left: HC-CARGO 170602. Lens: HC-CARGO 171808.

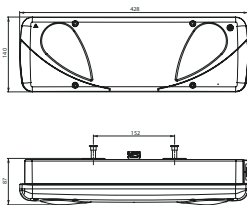

Bulb incl.: No  
Watt: 21/5  
Watt 2: 21  
Watt 3: 21  
Watt 4: 5

Dim.: 428x140x87 mm  
Dist. mount. holes:  
152 mm

Socket type: BAY15d  
Socket type 2: BA15S  
Socket type 3: BAU15s  
Socket type 4: BA15S  
Material: Shockproof plastic  
Shape: Rectangular  
Reflector: w/  
Flasher light: w/  
Rear/fog lamp: w/  
Reverse light: w/  
Sidemarker lamp: w/  
Tail light: w/  
Stop light: w/  
RH/LH: RH  
E-approval: Yes

**171810 Lens, Rear Lamp**

Servicing: HC-CARGO 171806, 171807, 171808, 171809

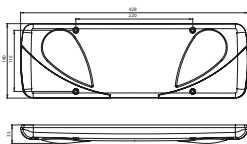

Dim.: 428x140 mm

**171870 Multi Function Lamp**

Servicing: HC-CARGO 171818, 171872

Multi connector: HC-CARGO 171537, 171538. Lens: HC-CARGO 171834. Right: HC-CARGO 171871.

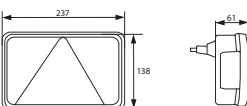

Bulb incl.: Yes  
Voltage: 12

Dim.: 237x138x61 mm

Shape: Rectangular  
Flasher light: w/  
Numberplate light: w/  
Rear/fog lamp: w/  
Sidemarker: w/  
Stop light: w/  
RH/LH: LH  
E-approval: Yes

**171871** Multi Function Lamp

Servicing: HC-CARGO 171818, 171872

Multi connector: Cargo 171537, 171538. Lens: Cargo 171833. Left: Cargo 171870.

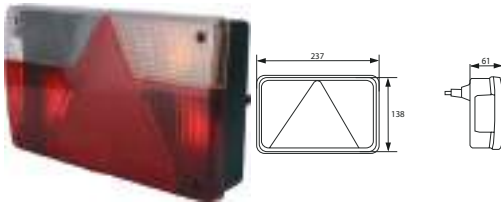

Bulb incl.: Yes  
Voltage: 12

Dim.: 237x138x61 mm

Shape: Rectangular  
Flasher light: w/  
Numberplate light: w/  
Rear/fog lamp: w/  
Sidemarker: w/  
Stop light: w/  
RH/LH: RH  
E-approval: Yes

**171917** Multi Function Lamp

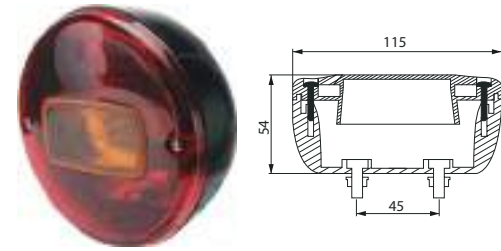

Bulb incl.: No  
Watt: 5  
Watt 2: 18  
Watt 3: 18

Dim.: 115x54 mm  
OD: 115 mm  
Dist. mount. holes: 45 mm

Bulb type: 10.5x36 mm  
Bulb type 2: 15x41 mm  
Bulb type 3: 15x41 mm  
Socket type: S8.5  
Socket type 2: S8.5  
Socket type 3: S8.5  
Colour/glass: Red/yellow  
Material/dome: PMMA  
Shape: Round  
Fixing screw: 2  
Flasher light: w/  
Tail light: w/  
Stop light: w/  
RH/LH: RH/LH

**172015** Cable w/ plug

Cover of click-in connector HC-CARGO 172016.



Type: Clip-on  
Type: Round

**172016** Cover of click-in connector

Servicing: HC-CARGO 171730, 171731, 171732, 171733, 171734, 172015



ID: 12.8 mm  
Total length: 30.6 mm  
Height: 16.3 mm  
Width: 16.5 mm

**172066** Multiconnector 7 pin

Servicing: HC-CARGO 171506, 171756, 171757, 171802, 171803, 171927, 171928, 171929, 171930, 172061, 172062, 172063, 172064



Type/terminal: Round  
Colour: Black  
No./poles: 7  
Plug: Female

**TRAILER LAMPS LED**

**160971** Load Resistor 24 V

Contains: 2 pcs.



Voltage: 24  
Amp: 1  
Watt: 50

Length: 50 mm  
Width: 15 mm

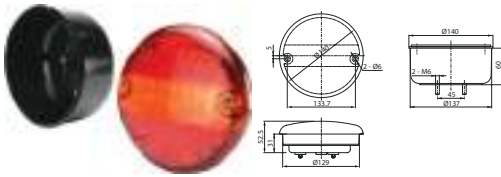
**171549 LED Multifunction Lamp**
*Mounting kit: HC-CARGO 171266.*

**Voltage:** 9-33

**Dim.:** 140x60 mm  
**Dist. mount. holes:** 45 mm

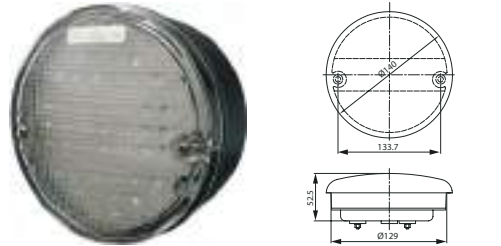
**Type:** LED  
**Colour:** Black  
**Material:** Shockproof plastic  
**Shape:** Circular  
**Fixing screw:** 2  
**Flasher light:** w/  
**Tail light:** w/  
**Stop light:** w/  
**No./LEDs:** 63  
**E-approval:** Yes

**171550 LED Multifunction Lamp**
*w/ transparent lens when light is off. Mounting kit: HC-CARGO 171266.*

**Voltage:** 9-33

**Dim.:** 140x52.5 mm  
**Dist. mount. holes:** 45 mm

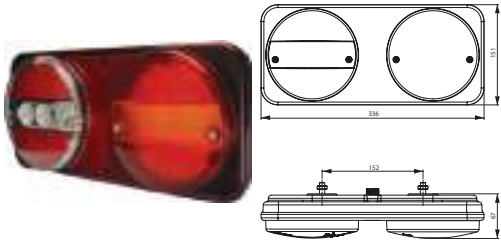
**Type:** LED  
**Material:** Shockproof plastic  
**Shape:** Round  
**Fixing screw:** 2  
**Flasher light:** w/  
**Tail light:** w/  
**Stop light:** w/  
**No./LEDs:** 63  
**E-approval:** Yes

**171665 LED Multifunction Lamp**
*Right: HC-CARGO 171666.*

**Voltage:** 12/24

**Dim.:** 336x151x67 mm  
**Dist. mount. holes:** 152 mm

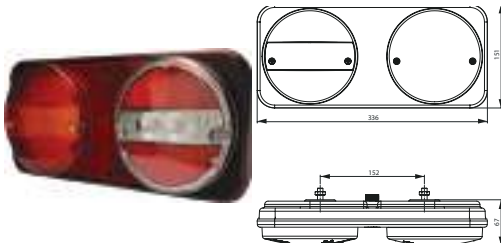
**Type:** LED  
**Material:** Shockproof plastic  
**Shape:** Rectangular  
**Reflector:** w/  
**Flasher light:** w/  
**Reverse light:** w/  
**Tail light:** w/  
**Stop light:** w/  
**RH/LH:** LH  
**E-approval:** Yes

**171666 LED Multifunction Lamp**
*Left: HC-CARGO 171665.*

**Voltage:** 12/24

**Dim.:** 336x151x67 mm  
**Dist. mount. holes:** 152 mm

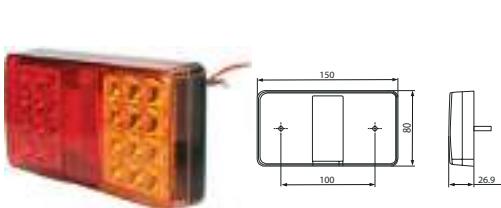
**Type:** LED  
**Material:** Shockproof plastic  
**Shape:** Rectangular  
**Reflector:** w/  
**Flasher light:** w/  
**Reverse light:** w/  
**Tail light:** w/  
**Stop light:** w/  
**RH/LH:** RH  
**E-approval:** Yes

**171667 LED Multifunction Lamp**
*White = ground. Brown = tail light. Red = stop. Yellow = indicator.*

**Voltage:** 12/24

**Dim.:** 150x80x26.9 mm  
**Dist. mount. holes:** 100 mm

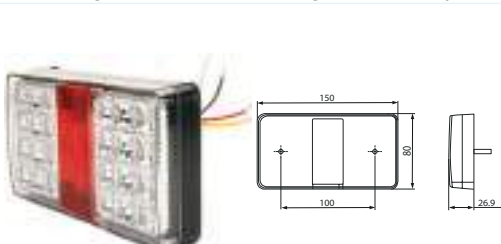
**Type:** LED  
**Material:** Plastic  
**Shape:** Rectangular  
**Reflector:** w/  
**Flasher light:** w/  
**Tail light:** w/  
**Stop light:** w/  
**No./LEDs:** 24  
**Tightness norm:** IP 67  
**E-approval:** Yes

**171668 LED Multifunction Lamp**
*White = ground. Brown = tail light. Red = stop. Yellow = indicator.*

**Voltage:** 12/24

**Dim.:** 150x80x26.9 mm  
**Dist. mount. holes:** 100 mm

**Type:** LED  
**Colour/glass:** Transparent  
**Material:** Shockproof plastic  
**Material/dome:** Glass  
**Shape:** Rectangular  
**Reflector:** w/  
**Flasher light:** w/  
**Tail light:** w/  
**Stop light:** w/  
**No./LEDs:** 24  
**Tightness norm:** IP 67  
**E-approval:** Yes

**171725 LED Multifunction Lamp**

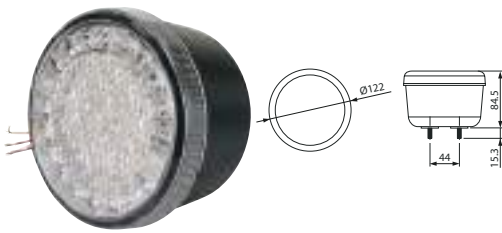
Ring: amber, center: red.



Voltage: 12/24

Dim.: 122x84.5 mm  
 OD: 122 mm  
 Cable length: 150 mm  
 Dist. mount. holes:  
 44 mm

Type: LED  
 Material: Shockproof plastic  
 Material/dome: Shockproof plastic  
 Shape: Round  
 Fixing screw: 6  
 Flasher light: w/  
 Tail light: w/  
 Stop light: w/  
 No./LEDs: 44  
 E-approval: Yes

**171756 LED Multifunction Lamp**

Multi-plug: HC-CARGO 171788, 172066.

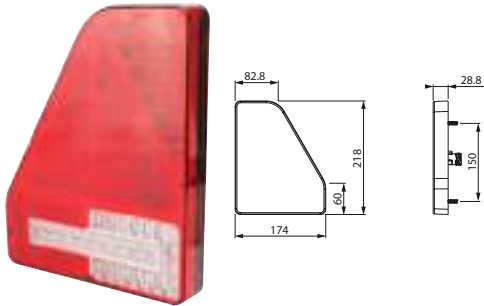

Voltage: 12/24

Dim.: 174x218x28.8 mm  
 Dist. mount. holes:  
 150 mm

Type: Tail/position lamp  
 Material: Shockproof plastic  
 Material/dome: Shockproof plastic  
 Shape: Triangle  
 Reflector: w/  
 Flasher light: w/  
 Rear/fog lamp: w/  
 Reverse light: w/  
 Tail light: w/  
 Stop light: w/  
 RH/LH: RH  
 Tightness norm: IP 67  
 Approvals: CE  
 E-approval: Yes

**171757 LED Multifunction Lamp**

Multi-plug: HC-CARGO 171788, 172066.

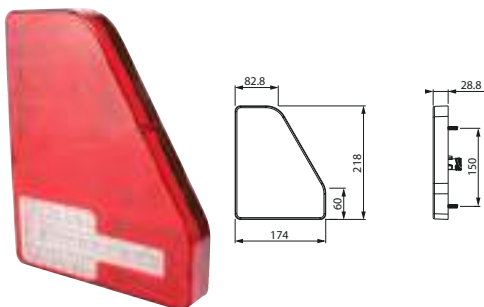

Voltage: 12/24

Dim.: 174x218x28.8 mm  
 Dist. mount. holes:  
 150 mm

Type: Tail/position lamp  
 Material: Shockproof plastic  
 Material/dome: Shockproof plastic  
 Shape: Triangle  
 Reflector: w/  
 Flasher light: w/  
 Rear/fog lamp: w/  
 Reverse light: w/  
 Tail light: w/  
 Stop light: w/  
 RH/LH: LH  
 Tightness norm: IP 67  
 Approvals: CE  
 E-approval: Yes

**171758 LED Multifunction Lamp**

White = ground. Red = stop. Black = tail. Yellow = indicator. Brown = reverse.

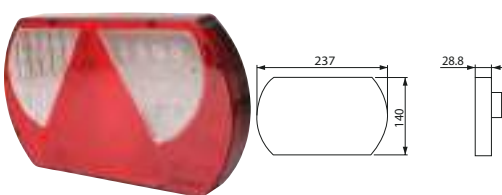

Voltage: 12/24

Dim.: 237x140x28.8 mm  
 Cable length: 2000 mm  
 Dist. mount. holes:  
 152 mm

Type: Tail lamp  
 Material: Shockproof plastic  
 Material/dome: Shockproof plastic  
 Shape: Oval  
 Mount.: 2 screws  
 Reflector: w/  
 Flasher light: w/  
 Numberplate light: w/  
 Reverse light: w/  
 Tail light: w/  
 Stop light: w/  
 RH/LH: RH  
 Tightness norm: IP 66  
 E-approval: Yes

**171759 LED Multifunction Lamp**

White = ground. Red = stop. Black = tail. Yellow = indicator. Blue = fog.

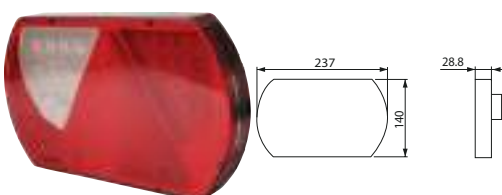

Voltage: 12/24

Dim.: 237x140x28.8 mm  
 Cable length: 2000 mm  
 Dist. mount. holes:  
 152 mm

Type: Tail lamp  
 Material: Shockproof plastic  
 Material/dome: Shockproof plastic  
 Shape: Oval  
 Mount.: 2 screws  
 Reflector: w/  
 Flasher light: w/  
 Numberplate light: w/  
 Rear/fog lamp: w/  
 Tail light: w/  
 Stop light: w/  
 RH/LH: LH  
 Tightness norm: IP 66  
 E-approval: Yes

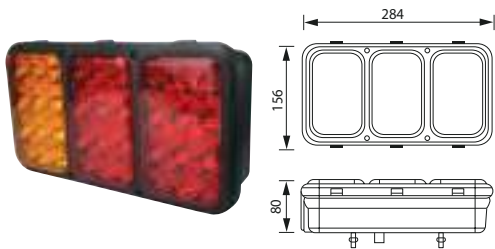

**171772 LED Multifunction Lamp**
*White=ground. Brown=tail. Yellow=flasher. Red=stop.*

**Voltage:** 24

**Dim.:** 284x156x102 mm  
**Dist. mount. holes:** 130x78 mm

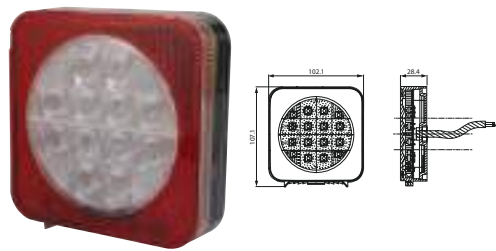
**Type:** Tail lamp  
**Material:** Polypropylene  
**Material/dome:** PMMA  
**Shape:** Rectangular  
**Mount.:** 4 screws  
**Reflector:** w/  
**Flasher light:** w/  
**Tail light:** w/  
**Stop light:** w/  
**No./LEDs:** 3x16  
**RH/LH:** RH/LH  
**E-approval:** Yes

**171789 LED Multifunction Lamp**
*Vertical mount.*

**Voltage:** 12/24

**Dim.:** 102.1x107.1x28.4 mm  
**Cable length:** 500 mm  
**Dist. mount. holes:** 45 mm

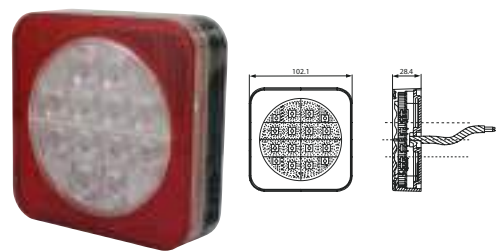
**Type:** Tail lamp  
**Bulb type:** LED  
**Material:** Polycarbonate  
**Material/dome:** Polycarbonate  
**Shape:** Square  
**Mount.:** 2 screws  
**Reflector:** w/  
**Flasher light:** w/  
**Numberplate light:** w/  
**Tail light:** w/  
**Stop light:** w/  
**No./LEDs:** 12  
**RH/LH:** RH/LH  
**Tightness norm:** IP 67  
**E-approval:** Yes

**171790 LED Multifunction Lamp**
*Vertical mount.*

**Voltage:** 12/24

**Dim.:** 102.1x28.4 mm  
**Cable length:** 500 mm  
**Dist. mount. holes:** 45 mm

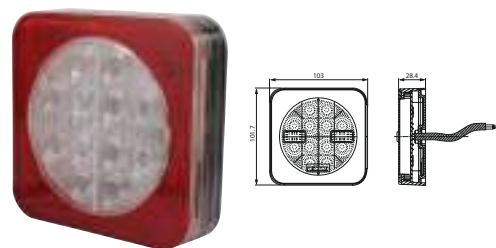
**Type:** Tail lamp  
**Material:** Polycarbonate  
**Material/dome:** Polycarbonate  
**Shape:** Square  
**Mount.:** 2 screws  
**Reflector:** w/  
**Flasher light:** w/  
**Tail light:** w/  
**Stop light:** w/  
**No./LEDs:** 12  
**RH/LH:** RH/LH  
**Tightness norm:** IP 67  
**E-approval:** Yes

**171791 LED Multifunction Lamp**
*Horizontal mount.*

**Voltage:** 12/24

**Dim.:** 103x101.7x28.4 mm  
**Cable length:** 500 mm  
**Dist. mount. holes:** 45 mm

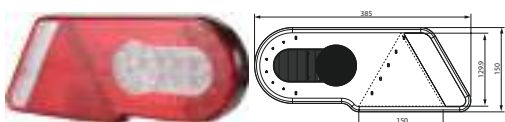
**Type:** Tail lamp  
**Material:** Polycarbonate  
**Material/dome:** Polycarbonate  
**Shape:** Square  
**Mount.:** 2 screws  
**Reflector:** w/  
**Flasher light:** w/  
**Numberplate light:** w/  
**Tail light:** w/  
**Stop light:** w/  
**No./LEDs:** 12  
**RH/LH:** RH/LH  
**Tightness norm:** IP 67  
**E-approval:** Yes

**171927 LED Multifunction Lamp**
*Left: HC-CARGO 171928. Multi-plug: HC-CARGO 171788, 172066.*

**Voltage:** 12-24

**Dim.:** 385x150x34.1 mm  
**Dist. mount. holes:** 152.3 mm

**Type:** LED  
**Shape:** Rectangular  
**Reflector:** w/  
**Flasher light:** w/  
**Rear/fog lamp:** w/  
**Reverse light:** w/  
**Tail light:** w/  
**Stop light:** w/  
**RH/LH:** RH  
**Tightness norm:** IP 67  
**Approvals:** CE  
**E-approval:** Yes

**171928 LED Multifunction Lamp**

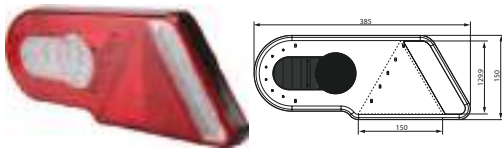
Right: HC-CARGO 171927. Multi-plug: HC-CARGO 171788, 172066.



Voltage: 12-24

Dim.: 385x150x34.1 mm  
Dist. mount. holes:  
152 mm

Type: LED  
Shape: Rectangular  
Reflector: w/  
Flasher light: w/  
Rear/fog lamp: w/  
Reverse light: w/  
Tail light: w/  
Stop light: w/  
RH/LH: LH  
Tightness norm: IP 67  
Approvals: CE  
E-approval: Yes

**171929 LED Multifunction Lamp**

Left: HC-CARGO 171930. Multi-plug: HC-CARGO 171788, 172066.



Voltage: 12-24

Dim.: 240.3x140x31 mm  
Dist. mount. holes:  
152 mm

Type: LED  
Shape: Rectangular  
Reflector: w/  
Flasher light: w/  
Rear/fog lamp: w/  
Reverse light: w/  
Tail light: w/  
Stop light: w/  
RH/LH: RH  
Tightness norm: IP 67  
Approvals: CE  
E-approval: Yes

**171930 LED Multifunction Lamp**

Right: HC-CARGO 171929. Multi-plug: HC-CARGO 171788, 172066.



Voltage: 12-24

Dim.: 240.3x140x31 mm  
Dist. mount. holes:  
152 mm

Type: LED  
Shape: Rectangular  
Reflector: w/  
Flasher light: w/  
Rear/fog lamp: w/  
Reverse light: w/  
Tail light: w/  
Stop light: w/  
RH/LH: LH  
Tightness norm: IP 67  
Approvals: CE  
E-approval: Yes

**171952 LED Multifunction Lamp**



Voltage: 12-24

Dim.: 150x80x26.5 mm  
Cable length: 300 mm  
Dist. mount. holes:  
100 mm

Mount.: 2 screws  
Reflector: w/  
No./reflectors: 1  
Flasher light: w/  
Tail light: w/  
Stop light: w/  
Tightness norm: IP 67  
Approvals: CE  
E-approval: Yes

**172061 LED Multifunction Lamp**

Lens: HC-CARGO 172065. Left: HC-CARGO 172062. Plug: HC-CARGO 171788, 172066.

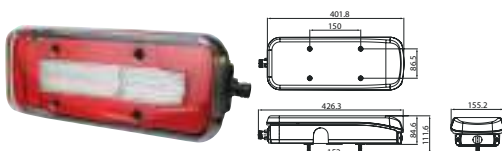

Voltage: 12-24

Dim.: 426.3x155.2x111.6 mm  
Dist. mount. holes:  
152 mm

Type: LED  
Material: PP  
Material/dome: Polycarbonate  
Shape: Rectangular  
Reflector: w/  
Flasher light: w/  
Rear/fog lamp: w/  
Reverse light: w/  
Sidemarker lamp: w/  
Tail light: w/  
Stop light: w/  
RH/LH: RH  
E-approval: Yes

**172062 LED Multifunction Lamp**

Lens: HC-CARGO 172065. Right: HC-CARGO 172061. Plug: HC-CARGO 171788, 172066.



Voltage: 12-24

Dim.: 426.3x155.2x111.6 mm  
Dist. mount. holes: 152 mm

Type: LED  
Material: PP  
Material/dome: Polycarbonate  
Shape: Rectangular  
Reflector: w/  
Flasher light: w/  
Rear/fog lamp: w/  
Reverse light: w/  
Sidemarker lamp: w/  
Tail light: w/  
Stop light: w/  
RH/LH: LH  
E-approval: Yes

**172063 LED Multifunction Lamp**

Lens: HC-CARGO 172067. Left: HC-CARGO 172064. Plug: HC-CARGO 171788, 172066.

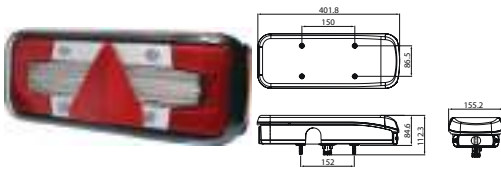

Voltage: 12-24

Dim.: 401.8x155.2x112.3 mm  
Dist. mount. holes: 152 mm

Type: LED  
Material: PP  
Material/dome: Polycarbonate  
Shape: Rectangular  
Reflector: w/  
Flasher light: w/  
Rear/fog lamp: w/  
Reverse light: w/  
Sidemarker lamp: w/  
Tail light: w/  
Stop light: w/  
RH/LH: RH  
E-approval: Yes

**172064 LED Multifunction Lamp**

Lens: HC-CARGO 172067. Right: HC-CARGO 172063. Plug: HC-CARGO 171788, 172066.



Voltage: 12-24

Dim.: 401.8x155.2x112.3 mm  
Dist. mount. holes: 152 mm

Type: LED  
Material: PP  
Material/dome: Polycarbonate  
Shape: Rectangular  
Reflector: w/  
Flasher light: w/  
Rear/fog lamp: w/  
Reverse light: w/  
Sidemarker lamp: w/  
Tail light: w/  
Stop light: w/  
RH/LH: LH  
E-approval: Yes

**172065 Lens, Rear Lamp**

Servicing: HC-CARGO 172061, 172062

**NEW PRODUCT**  
[www.hc-cargo.com](http://www.hc-cargo.com)

Dim.: 401.8x155.2 mm

Material/dome: Polycarbonate  
RH/LH: RH/LH

**172067 Lens, Rear Lamp**

Servicing: HC-CARGO 172063, 172064



Dim.: 401.8x155.2 mm

Material/dome: Polycarbonate  
RH/LH: RH/LH

**NUMBERPLATE LAMPS CONVENTIONAL**

**170002 Numberplate Lamp**

Servicing: Universal

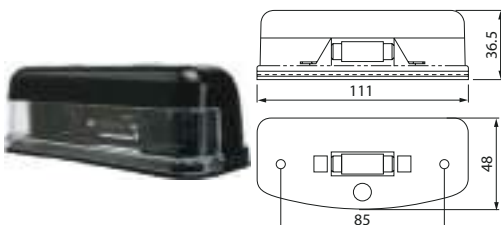

Bulb incl.: Yes  
Voltage: 12/24  
Watt: 5

Dim.: 111x36.5x48 mm

Socket type: S8.5  
Colour: Black  
Shape: Rectangular  
Approvals: CE

**170936** Numberplate Lamp

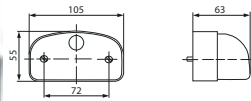

Bulb incl.: No  
Voltage: 12  
Watt: 5

Dim.: 105x55x63 mm  
Dist. mount. holes:  
72 mm

Type: Illumination of numberplate  
Socket type: S8.5  
Colour: Black  
Material: Shockproof plastic  
Fixing screw: 2  
Numberplate light: w/  
E-approval: Yes

**171045** Numberplate Lamp

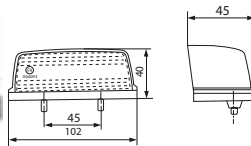

Bulb incl.: No  
Voltage: 12/24  
Watt: 5

Dim.: 102x40x45 mm  
Dist. mount. holes:  
45 mm

Type: Illumination of numberplate  
Socket type: S8.5  
Colour: Black  
Material: Shockproof plastic  
Shape: Rectangular  
Fixing screw: 2  
E-approval: Yes

**171166** Numberplate Lamp

*Universal.*

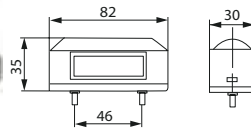

Bulb incl.: No  
Voltage: 12/24  
Watt: 5

Dim.: 82x35x30 mm  
Dist. mount. holes:  
46 mm

Type: Illumination of numberplate  
Socket type: S8.5  
Colour: Black  
Fixing screw: 2  
Numberplate light: w/  
E-approval: Yes

**171224** Numberplate Lamp

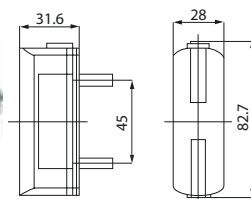

Bulb incl.: No  
Voltage: 12/24  
Watt: 5

Dim.: 82.7x28x31.6 mm  
Dist. mount. holes:  
45 mm

Type: Illumination of numberplate  
Socket type: S8.5  
Colour: Black  
Material: Shockproof plastic  
Shape: Rectangular  
Fixing screw: 2  
E-approval: Yes

**171225** Numberplate Lamp

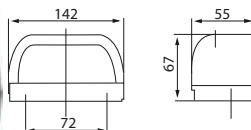

Bulb incl.: No  
Voltage: 12/24  
Watt: 10

Dim.: 142x67x55 mm  
Dist. mount. holes:  
72 mm

Type: Illumination of numberplate  
Socket type: BA15S  
Material: Shockproof plastic  
Fixing screw: 2  
E-approval: Yes

**171345** Numberplate Lamp

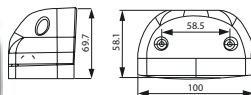

Bulb incl.: No  
Watt: 5

Dim.: 100x58.1x69.7 mm  
Dist. mount. holes:  
58.5 mm

Type: Illumination of numberplate  
Socket type: S8.5  
Colour: Black  
Material: Plastic  
Fixing screw: 2  
E-approval: Yes

**171823** Numberplate Lamp

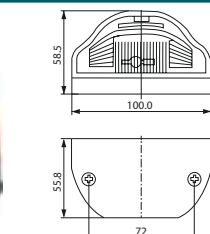

Bulb incl.: No  
Watt: 5

Dim.: 100x58.5x55.8 mm  
Dist. mount. holes:  
72 mm

Type: Illumination of numberplate  
Socket type: S8.5  
Colour: Black  
Colour/glass: Red  
Material: Plastic  
Fixing screw: 2  
Numberplate light: w/  
E-approval: Yes

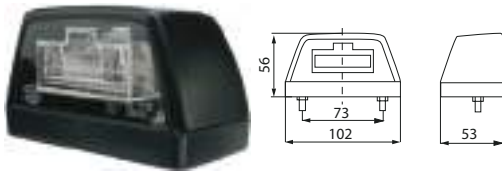
**NUMBERPLATE LAMPS LED**
**171622 LED Numberplate Lamp**

Voltage: 24

 Dim.: 102x56x53 mm  
 Dist. mount. holes:  
 72 mm

 Type: LED  
 Colour: Black  
 Colour/glass: Transparent  
 Numberplate light: w/  
 No./LEDs: 4  
 E-approval: Yes

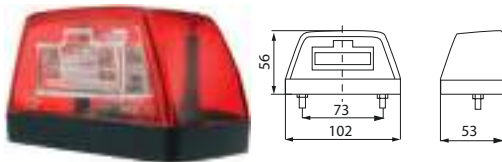
**171624 LED Numberplate Lamp**

Voltage: 24

 Dim.: 102x56x53 mm  
 Dist. mount. holes:  
 73 mm

 Type: LED  
 Colour: Black  
 Colour/glass: Red  
 Shape: Rectangular  
 Numberplate light: w/  
 LEDs: w/  
 E-approval: Yes

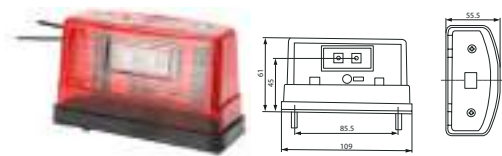
**171709 LED Numberplate Lamp**

Voltage: 12/24

 Dim.: 109x61x55.5 mm  
 Dist. mount. holes:  
 85.5 mm

 Type: LED  
 Socket type: LED  
 Colour: Red  
 Material: Shockproof plastic  
 Fixing screw: 2  
 Numberplate light: w/  
 E-approval: Yes

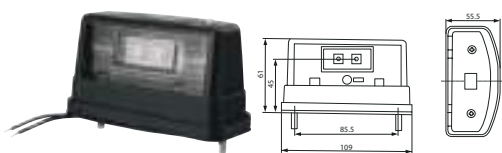
**171714 LED Numberplate Lamp**

Voltage: 12/24

 Dim.: 109x61x55.5 mm  
 Dist. mount. holes:  
 85.5 mm

 Type: LED  
 Socket type: LED  
 Colour: Black  
 Material: Shockproof plastic  
 Numberplate light: w/

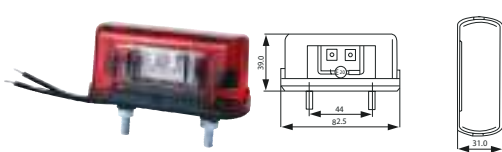
**171715 LED Numberplate Lamp**

Voltage: 12/24

 Dim.: 82.5x39x31 mm  
 Dist. mount. holes:  
 44 mm

 Type: LED  
 Socket type: LED  
 Colour/glass: Red  
 Material: Shockproof plastic  
 Fixing screw: 2  
 Numberplate light: w/  
 Tightness norm: IP 68  
 E-approval: Yes

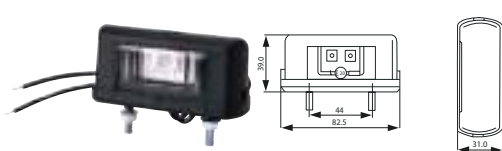
**171716 LED Numberplate Lamp**

Voltage: 12/24

 Dim.: 82.5x39x31 mm  
 Dist. mount. holes:  
 44 mm

 Type: LED  
 Socket type: LED  
 Colour: Black  
 Fixing screw: 2  
 Numberplate light: w/  
 E-approval: Yes

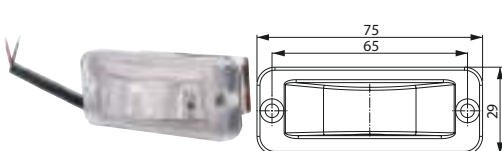
**171738 LED Numberplate Lamp**

Voltage: 24

 Dim.: 75x29x34 mm  
 Cable length: 300 mm  
 Dist. mount. holes:  
 65 mm

 Type: LED  
 Mount.: 2 screws  
 Numberplate light: w/  
 No./LEDs: 3

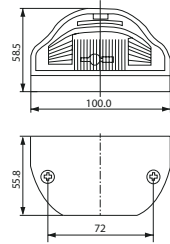

**171824 LED Numberplate Lamp**

Voltage: 12/24  
Watt: 0.5-1.1

Dim.: 100x58.5x55.8 mm  
Cable length: 1000 mm  
Dist. mount. holes: 72 mm

Type: LED  
Colour: Black  
Colour/glass: White  
Material: Plastic  
Fixing screw: 2  
Numberplate light: w/  
No./LEDs: 2  
E-approval: Yes

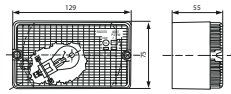
**REVERSING LAMPS CONVENTIONAL**
**170689 Reversing Lamp**

Bulb incl.: No  
Watt: 21

Dim.: 129x75x55 mm  
Dist. mount. holes: 56 mm

Socket type: BA15S  
Shape: Rectangular  
Bracket: Straight  
Fixing screw: 1  
Reverse light: w/  
E-approval: Yes

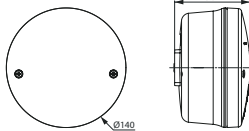
**170934 Reversing Lamp**

Bulb incl.: No  
Watt: 21

Dim.: 140x90 mm  
Dist. mount. holes: 45 mm

Socket type: BA15S  
Colour: Black  
Material: Shockproof plastic  
Shape: Round  
Fixing screw: 2  
Reverse light: w/  
Wiring system: w/  
E-approval: Yes

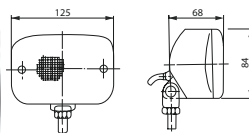
**170935 Reversing Lamp**

Bulb incl.: No  
Watt: 21

Dim.: 125x84x68 mm

Socket type: BA15S  
Colour: Black  
Material: Shockproof plastic  
Shape: Rectangular  
Bracket: Pendant  
Fixing screw: M10  
Reverse light: w/  
E-approval: Yes

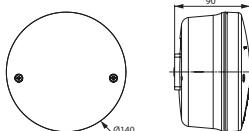
**171222 Reversing Lamp**

Bulb incl.: No  
Voltage: 12/24  
Watt: 55  
Watt 2: 70

Dim.: 140x90 mm  
Dist. mount. holes: 45 mm

Bulb type: H3  
Bulb type 2: H3  
Socket type: PK22s  
Socket type 2: PK22s  
Colour: Black  
Material: Shockproof plastic  
Shape: Circular  
Fixing screw: 2  
Wiring system: w/  
E-approval: Yes

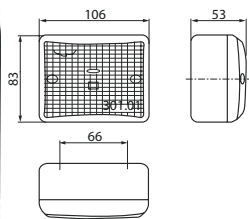
**172014 Reversing Lamp**

Bulb incl.: No  
Watt: 21

Dim.: 106x83x53 mm  
Dist. mount. holes: 66 mm

Socket type: BA15S  
Colour: Black  
Colour/glass: White  
Material: ABS plastic  
Material/dome: PMMA  
Shape: Rectangular  
Fixing screw: 2  
Reverse light: w/  
Approvals: CE  
E-approval: Yes

## REVERSING LAMPS LED

### 170909 LED Fog/Reverse Lamp

Lens and o-ring: HC-CARGO 170910.

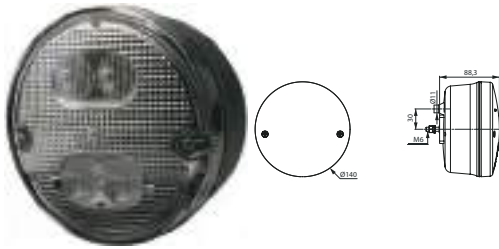

Voltage: 12/24

Dim.: 140x88.3 mm  
OD: 140 mm  
Dist. mount. holes:  
45 mm

Type: LED  
Colour/glass: White  
Material: Shockproof plastic  
Shape: Round  
Fixing screw: 2  
Rear/fog lamp: w/  
Tail light: w/  
LEDs: w/  
No./LEDs: 4  
E-approval: Yes

### 171684 LED Reversing Lamp

Can be flush mounted by using HC-CARGO 171266.

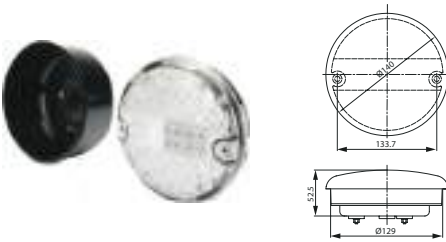

Voltage: 9-33  
Watt: 8

Dim.: 140x52.5 mm  
Dist. mount. holes:  
45 mm

Type: Reversing lamp  
Colour: Transparent  
Material: Shockproof plastic  
Shape: Circular  
No./LEDs: 61  
Approvals: ECE R23  
E-approval: Yes

### 171726 LED Fog/Reverse Lamp

Ring: clear, center: red.

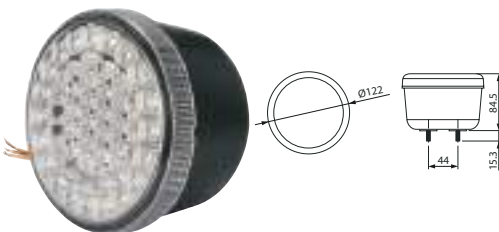

Voltage: 12/24

Dim.: 122x84.5 mm  
OD: 122 mm  
Cable length: 150 mm  
Dist. mount. holes:  
44 mm

Type: LED  
Material: Shockproof plastic  
Material/dome: Shockproof plastic  
Rear/fog lamp: w/  
Reverse light: w/  
No./LEDs: 38  
E-approval: Yes

### 172007 LED Reversing Lamp



Voltage: 10-30  
Watt: 18  
Kelvin: 6000  
Lumen: 1260

Dim.: 89x58 mm

Type: Reversing lamp  
Bulb type: 6 LED  
Material: Cast aluminum  
Material/dome: Polycarbonate  
Shape: Round  
Reverse light: w/  
Tightness norm: IP 67  
Approvals: ECE R23  
E-approval: Yes

## SPARE PARTS

### 170910 Lens, Rear Lamp

Servicing: HC-CARGO 170909

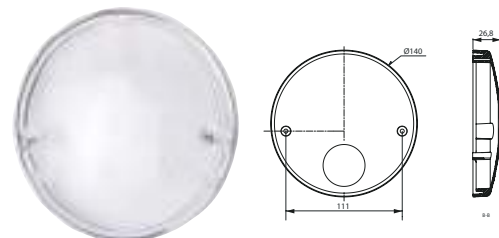

Dim.: 140x26.8 mm  
Dist. mount. holes:  
111 mm

Colour: White  
Shape: Round

## REAR FOG LAMPS CONVENTIONAL

### 170688 Rear Fog Lamp

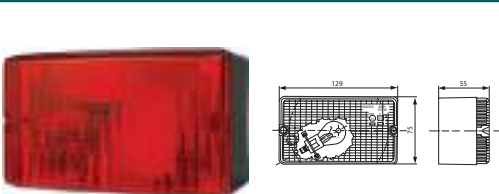

Bulb incl.: No  
Watt: 21

Dim.: 129x75x55 mm  
Dist. mount. holes:  
56 mm

Socket type: BA15S  
Shape: Rectangular  
Bracket: Straight  
Rear/fog lamp: w/  
E-approval: Yes

**170928** Rear Fog Lamp

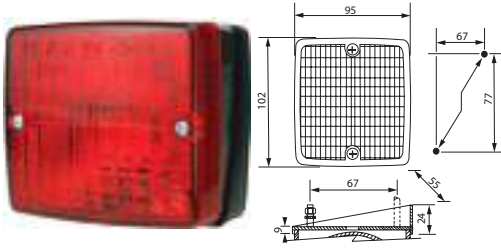

Bulb incl.: No  
Watt: 21

Dim.: 102x95x55 mm  
Dist. mount. holes:  
77 mm

Socket type: BA15S  
Colour: Black  
Material: Shockproof plastic  
Shape: Rectangular  
Fixing screw: 2  
E-approval: Yes

**170929** Rear Fog Lamp

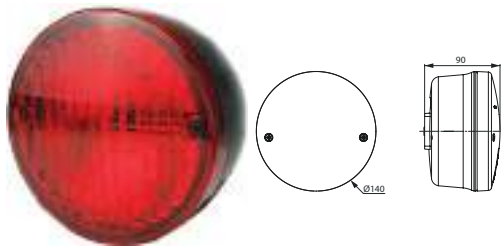

Bulb incl.: No  
Watt: 21

Dim.: 140x90 mm  
Dist. mount. holes:  
45 mm

Socket type: BA15S  
Colour: Black  
Material: Shockproof plastic  
Fixing screw: 2  
Rear/fog lamp: w/  
Wiring system: w/  
E-approval: Yes

**170930** Rear Fog Lamp

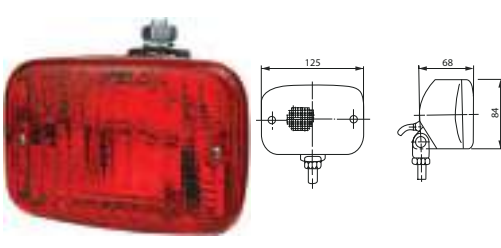

Bulb incl.: No  
Watt: 21

Dim.: 125x84x68 mm

Socket type: BA15S  
Colour: Black  
Material: Shockproof plastic  
Bracket: Pendant  
Fixing screw: 1  
Rear/fog lamp: w/  
E-approval: Yes

**171220** Rear Fog Lamp

w/ Grommet.

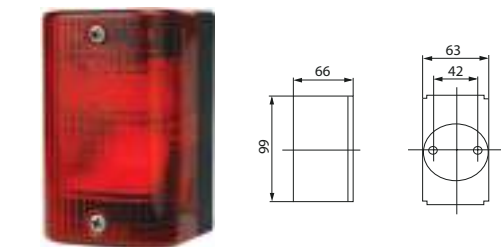

Bulb incl.: No  
Watt: 21

Dim.: 63x99x66 mm  
Dist. mount. holes:  
42 mm

Socket type: BA15S  
Material: Shockproof plastic  
Shape: Rectangular  
Sidemarker: w/  
E-approval: Yes

**REAR FOG LAMPS LED**

**170909** LED Fog/Reverse Lamp

Lens and o-ring: HC-CARGO 170910.

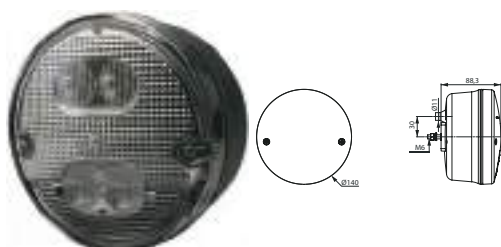

Voltage: 12/24

Dim.: 140x88.3 mm  
OD: 140 mm  
Dist. mount. holes:  
45 mm

Type: LED  
Colour/glass: White  
Material: Shockproof plastic  
Shape: Round  
Fixing screw: 2  
Rear/fog lamp: w/  
Tail light: w/  
LEDs: w/  
No./LEDs: 4  
E-approval: Yes

**171685** LED Rear Fog Lamp

Can be flush mounted by using HC-CARGO 171266.

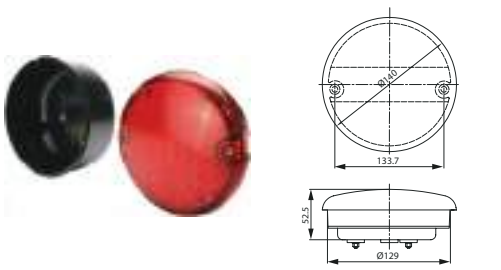

Voltage: 9-33

Dim.: 140x52.5 mm  
Dist. mount. holes:  
45 mm

Type: Rear fog lamp  
Colour: Red  
Material: Shockproof plastic  
Shape: Circular  
Rear/fog lamp: w/  
No./LEDs: 61

**SPARE PARTS**
**170910 Lens, Rear Lamp**

Servicing: HC-CARGO 170909

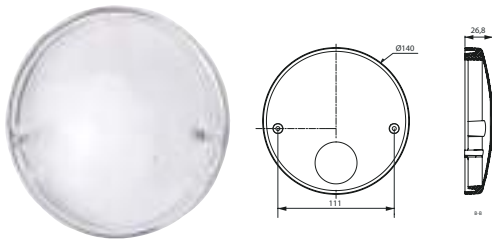
 Dim.: 140x26.8 mm  
 Dist. mount. holes:  
 111 mm

 Colour: White  
 Shape: Round

**TAIL-LIFT LAMPS CONVENTIONAL**
**170746 Tail Lift Lamp Set**

Set of cables, connectors and mounting screws. Incl. 12/24 V relay.

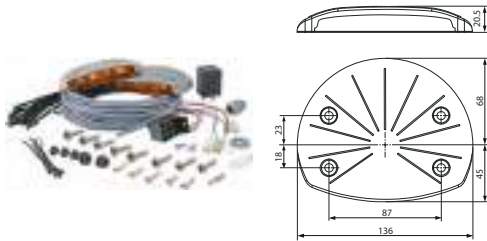
 Bulb incl.: Yes  
 Voltage: 24

 Dim.: 136x113x20.5 mm  
 Dist. mount. holes:  
 87 mm

 Material: Cast aluminum  
 Approvals: GGVS/ADR

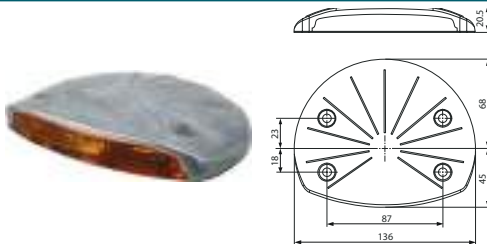
**170748 Tail Lift Lamp**

 Bulb incl.: Yes  
 Voltage: 24

 Dim.: 136x113x20.5 mm  
 Dist. mount. holes:  
 87 mm

 Material: Cast aluminum  
 Approvals: GGVS/ADR  
 E-approval: Yes

**TAIL-LIFT LAMPS LED**
**171621 LED Tail Lift Lamp**

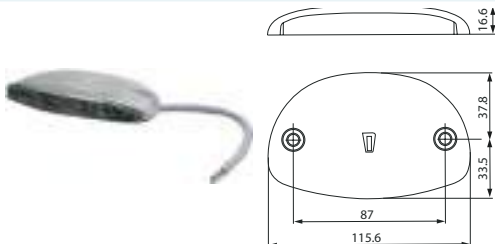
Dust and waterproof.



Voltage: 24

 Dim.: 115x71.3x16.6 mm  
 Dist. mount. holes:  
 87 mm

 Type: LED  
 Colour: Orange  
 Material: Alu/zinc  
 No./LEDs: 12  
 Approvals: GGVS/ADR

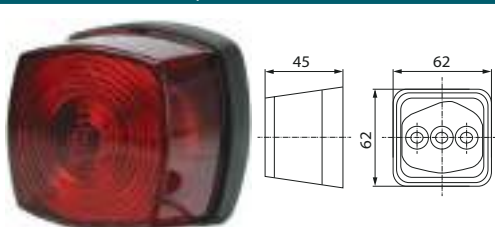
**TAIL LAMPS CONVENTIONAL**
**171173 Tail Lamp**

 Bulb incl.: No  
 Watt: 5

 Dim.: 62x62x45 mm  
 Dist. mount. holes:  
 30 mm

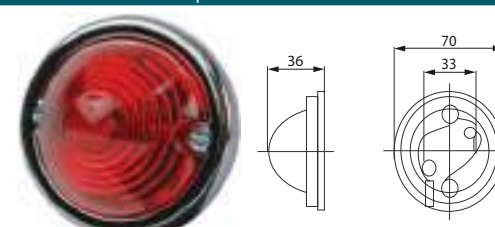
 Socket type: S8.5  
 Colour/glass: Red  
 Material: Shockproof plastic  
 Shape: Rectangular  
 Fixing screw: 2  
 Sidemarker: w/  
 E-approval: Yes

**171178 Tail Lamp**

 Bulb incl.: No  
 Watt: 5

 Dim.: 70x36 mm  
 Dist. mount. holes:  
 33 mm

 Socket type: S8.5  
 Colour/glass: Red  
 Material: Steel  
 Fixing screw: 2  
 E-approval: Yes

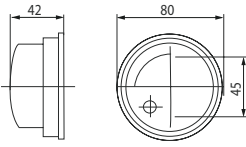
**171181** Tail Lamp



Bulb incl.: No  
Watt: 5

Dim.: 80x42 mm  
Dist. mount. holes:  
45 mm

Socket type: S8.5  
Colour/glass: Red  
Material: Shockproof plastic  
Fixing screw: 2  
E-approval: Yes

**171331** Tail Lamp

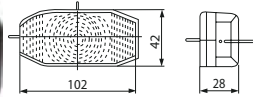

Bulb incl.: No  
Watt: 5

Dim.: 102x42x28 mm  
Dist. mount. holes:  
65 mm

Socket type: S8.5  
Colour/glass: Red  
Material: Plastic  
Fixing screw: 2  
E-approval: Yes

**TAIL LAMPS LED**

**171600** LED Tail Lamp

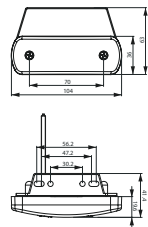

Voltage: 24

Dim.: 104x36x19.6 mm  
Cable length: 500 mm  
Dist. mount. holes:  
70 mm

Type: LED  
Colour/glass: Red  
Material: Shockproof plastic  
Shape: Rectangular  
Bracket: Angled  
Reflector: w/  
Fixing screw: 2  
Tail light: w/  
No./LEDs: 3  
E-approval: Yes

**171605** LED Tail Lamp

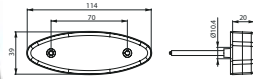

Voltage: 24

Dim.: 114x39x20 mm  
Cable length: 500 mm  
Dist. mount. holes:  
70 mm

Type: LED  
Colour/glass: Red  
Material: Shockproof plastic  
Shape: Oval  
Reflector: w/  
Fixing screw: 2  
Tail light: w/  
No./LEDs: 3  
Approvals: ADR  
E-approval: Yes

**171635** LED Tail Lamp

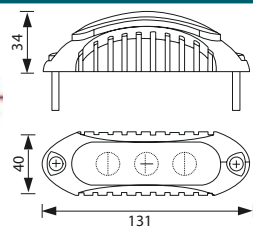

Voltage: 9-36

Dim.: 131x40x34 mm  
Dist. mount. holes:  
115 mm

Type: LED  
Colour/glass: Red  
Material: PP/PMMA  
Shape: Oval  
Tail light: w/  
No./LEDs: 3  
E-approval: Yes

**171637** LED Tail Lamp

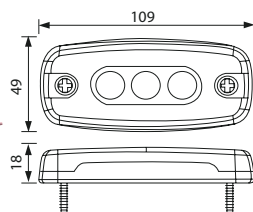

Voltage: 9-36  
Watt: 0.9

Dim.: 109x49x18 mm  
Dist. mount. holes:  
83 mm

Type: LED  
Colour/glass: Red  
Shape: Rectangular  
Reflector: w/  
Tail light: w/  
No./LEDs: 3  
E-approval: Yes

**171719** LED Tail Lamp

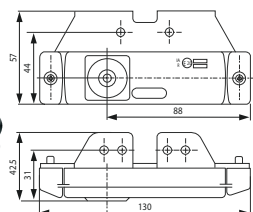

Voltage: 12/24

Dim.: 130x57x42.5 mm  
Dist. mount. holes:  
50 mm

Type: LED  
Colour/glass: Red  
Material: Shockproof plastic  
Shape: Rectangular  
Bracket: Angled  
Reflector: w/  
Tail light: w/  
No./LEDs: 1  
E-approval: Yes



**171720 LED Tail Lamp**

**Voltage:** 12/24

**Dim.:** 130x32x20.5 mm  
**Dist. mount. holes:**  
 50 mm

**Type:** LED  
**Colour/glass:** Red  
**Material:** Shockproof plastic  
**Shape:** Rectangular  
**Reflector:** w/  
**Tail light:** w/  
**No./LEDs:** 1  
**E-approval:** Yes

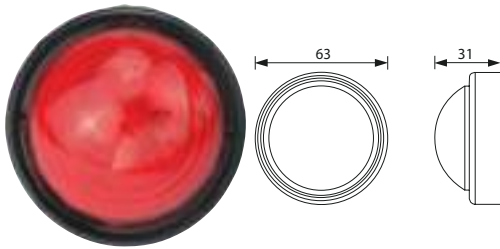
**171743 LED Tail Lamp**

**Voltage:** 9-36

**Dim.:** 63x31 mm  
**Cable length:** 300 mm  
**Dist. mount. holes:**  
 30 mm

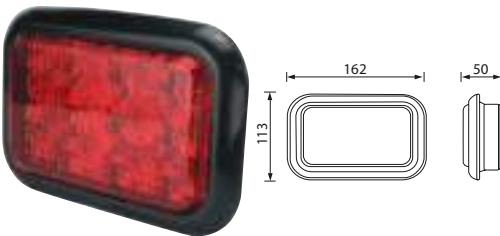
**Type:** LED  
**Colour:** Black  
**Colour/glass:** Red  
**Material:** PVC  
**Material/dome:** PMMA  
**Mount.:** 2 screws  
**Tail light:** w/  
**No./LEDs:** 3  
**Approvals:** ADR/SAE  
**E-approval:** Yes

**171771 LED Tail Lamp**

**Voltage:** 24  
**Watt:** 2.5

**Dim.:** 162x113x50 mm

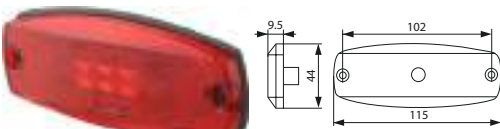
**Type:** Tail lamp  
**Colour/glass:** Red  
**Material:** ABS plastic  
**Material/dome:** PMMA  
**Shape:** Rectangular  
**Mount.:** Plan installation  
**Tail light:** w/  
**Stop light:** w/  
**No./LEDs:** 16  
**RH/LH:** RH/LH  
**E-approval:** Yes

**171840 LED Tail Lamp**

**Voltage:** 12/24  
**Watt:** 0.45-1.6

**Dim.:** 115x44x9.5 mm  
**Cable length:** 5000 mm  
**Dist. mount. holes:**  
 102 mm

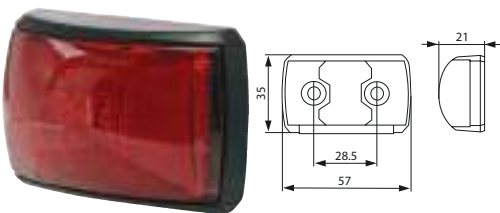
**Type:** LED  
**Colour:** White  
**Colour/glass:** Red  
**Material:** Polycarbonate  
**Material/dome:** Polycarbonate  
**Shape:** Rectangular  
**Mount.:** 2 screws  
**Reflector:** w/  
**Tail light:** w/  
**No./LEDs:** 3  
**Tightness norm:** IP 67  
**Approvals:** SAE  
**E-approval:** Yes

**171843 LED Tail Lamp**

**Voltage:** 12/24

**Dim.:** 57x35x21 mm  
**Cable length:** 400 mm  
**Dist. mount. holes:**  
 28 mm

**Type:** LED  
**Colour:** Black  
**Colour/glass:** Red  
**Shape:** Rectangular  
**Fixing screw:** 2  
**Tail light:** w/  
**No./LEDs:** 2  
**Tightness norm:** IP 67  
**E-approval:** Yes

**171861 LED Tail Lamp**

**Voltage:** 12/24  
**Watt:** 0.3-0.6

**Dim.:** 72x26x24 mm  
**Cable length:** 5000 mm

**Type:** LED  
**Colour:** Black  
**Colour/glass:** Red  
**Material:** PP  
**Material/dome:** PMMA  
**Shape:** Rectangular  
**Fixing screw:** 2  
**Tail light:** w/  
**No./LEDs:** 3  
**Approvals:** CE  
**E-approval:** Yes

**171867** LED Tail Lamp



Voltage: 12/24  
Watt: 0.3-0.6

Dim.: 72x26x24 mm  
Cable length: 5000 mm

Type: LED  
Colour: Black  
Colour/glass: Red  
Material: PP  
Material/dome: PMMA  
Shape: Rectangular  
Bracket: Adjustable  
Fixing screw: 2  
Tail light: w/  
No./LEDs: 3  
Approvals: CE  
E-approval: Yes

**172034** LED Tail Lamp

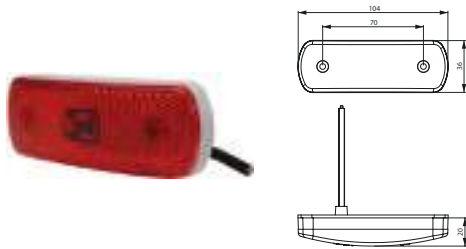

Voltage: 12/24

Dim.: 104x36x20 mm  
Cable length: 500 mm  
Dist. mount. holes: 70 mm

Type: LED  
Colour/glass: Red  
Material: Shockproof plastic  
Shape: Rectangular  
Reflector: w/  
Fixing screw: 2  
Tail light: w/  
No./LEDs: 3  
E-approval: Yes

**172035** LED Tail Lamp

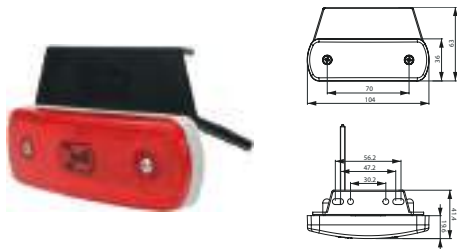

Voltage: 12/24

Dim.: 104x36x20 mm  
Cable length: 500 mm  
Dist. mount. holes: 70 mm

Type: LED  
Colour/glass: Red  
Material: Shockproof plastic  
Shape: Rectangular  
Bracket: Angled  
Reflector: w/  
Fixing screw: 2  
Tail light: w/  
No./LEDs: 3  
E-approval: Yes

**172040** LED Tail Lamp

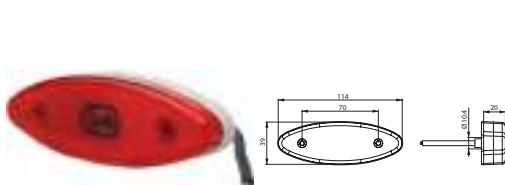

Voltage: 12/24

Dim.: 114x39x20 mm  
Cable length: 500 mm  
Dist. mount. holes: 70 mm

Type: LED  
Colour/glass: Red  
Material: Shockproof plastic  
Shape: Oval  
Reflector: w/  
Fixing screw: 2  
Tail light: w/  
No./LEDs: 3  
Approvals: ADR  
E-approval: Yes

**TAIL POSITION LAMPS CONVENTIONAL**

**170552** Tail/Position Lamp

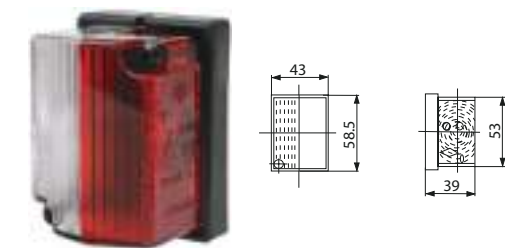

Bulb incl.: No  
Watt: 5

Dim.: 58.5x43x39 mm  
Dist. mount. holes: 25 mm

Socket type: S8.5  
Colour/glass: Red/white  
Material: Shockproof plastic  
Shape: Rectangular  
Fixing screw: 2  
Sidemarker: w/  
Tail light: w/  
RH/LH: RH/LH  
E-approval: Yes

**170632** Tail/Position Lamp

Lens: HC-CARGO 170635, 170636.

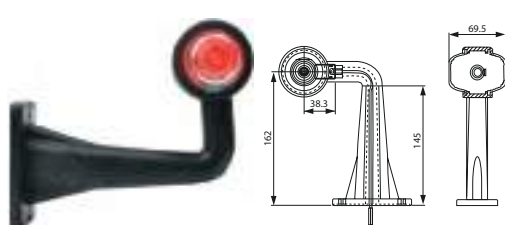

Bulb incl.: No  
Watt: 10

Dim.: 162x69.5 mm  
Dist. mount. holes: 76 mm

Socket type: BA15S  
Colour/glass: Red/white  
Sidemarker: w/  
Tail light: w/  
E-approval: Yes

**170633** Tail/Position Lamp

Lens: HC-CARGO 170635, 170636.

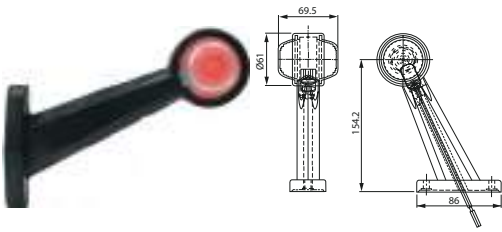

Bulb incl.: No  
Watt: 10

Dim.: 154.2x69.5 mm  
Dist. mount. holes:  
75 mm

Socket type: BA15S  
Colour/glass: Red/white  
Sidemarker: w/  
Tail light: w/  
E-approval: Yes

**170640** Tail/Position Lamp

Lens: HC-CARGO 170642, 170641. Bulb holder: HC-CARGO 170671.

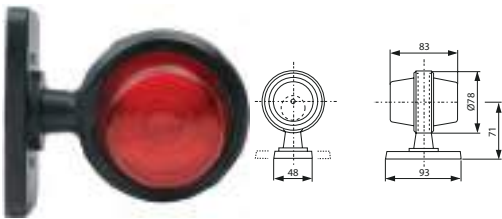

Bulb incl.: No  
Watt: 5

Dim.: 110x78x93 mm  
OD: 60 mm  
Dist. mount. holes:  
75 mm

Socket type: BA15S  
Colour/glass: Red/white  
Shape: Round  
Sidemarker: w/  
Tail light: w/  
E-approval: Yes

**170668** Tail/Position Lamp

Lens: HC-CARGO 170642, 170641. Bulb holder: HC-CARGO 170671. Bulbs: HC-CARGO 170773.

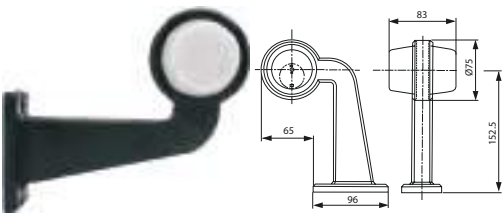

Bulb incl.: No  
Watt: 5

Dim.: 152.5x83 mm  
OD: 60 mm  
Dist. mount. holes:  
74 mm

Socket type: BA15S  
Colour/glass: Red/white  
Sidemarker: w/  
Tail light: w/  
E-approval: Yes

**171196** Tail/Position Lamp

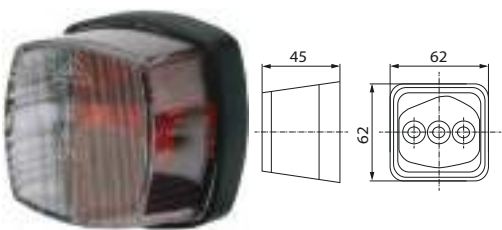

Bulb incl.: No  
Watt: 5

Dim.: 62x62x45 mm  
Dist. mount. holes:  
30 mm

Socket type: S8.5  
Colour/glass: Red/white  
Material: Shockproof plastic  
Shape: Square  
Fixing screw: 2  
Sidemarker: w/  
Tail light: w/  
RH/LH: RH/LH  
E-approval: Yes

**171627** Tail/Position Lamp

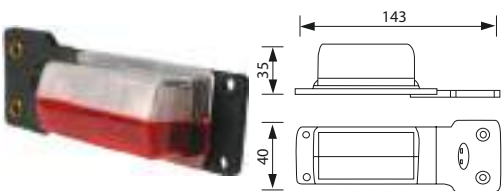

Bulb incl.: No  
Voltage: 12/24  
Watt: 5

Dim.: 143x40x35 mm  
Dist. mount. holes:  
30 mm

Socket type: S8.5  
Material: Plastic  
Shape: Rectangular  
Sidemarker: w/  
Tail light: w/  
Approvals: ADR  
E-approval: Yes

**171706** Tail/Position Lamp

Servicing: HC-CARGO 171627

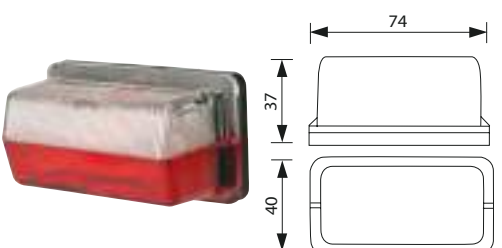

Bulb incl.: No  
Voltage: 12/24  
Watt: 5

Dim.: 74x40x37 mm  
Dist. mount. holes:  
45 mm

Socket type: S8.5  
Shape: Rectangular  
Sidemarker: w/  
Tail light: w/  
Approvals: ADR  
E-approval: Yes

**SPARE PARTS**
**170635** Lens

Servicing: HC-CARGO 170632, 170633

 Colour/glass: White  
 Material: Glass  
 Shape: Round

**170636** Lens

Servicing: HC-CARGO 170632, 170633

 Colour/glass: Red  
 Material: Glass  
 Shape: Round

**170641** Lens

Servicing: HC-CARGO 170640, 170668

 Colour/glass: Red  
 Material: Glass  
 Shape: Round

**170642** Lens

Servicing: HC-CARGO 170640, 170668



 Colour/glass: White  
 Material: Glass

**170671** Bulb Holder

Servicing: HC-CARGO 170640, 170668, 170713

**TAIL POSITION LAMPS LED**
**171528** LED Tail-Position Lamp

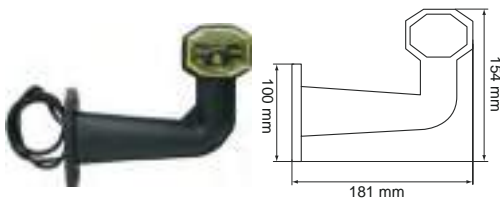
Flange 100x41 mm.



Voltage: 24

 Dim.: 181x154x48 mm  
 Cable length: 700 mm  
 Dist. mount. holes:  
 73 mm

 Type: LED  
 Colour/glass: Red/white  
 Material: Rubber  
 Material/dome: Shockproof plastic  
 Fixing screw: 2  
 Sidemarker: w/  
 Tail light: w/  
 No./LEDs: 2x1  
 RH/LH: RH/LH  
 E-approval: Yes

**171529** LED Tail-Position Lamp

Flange 100x41 mm.

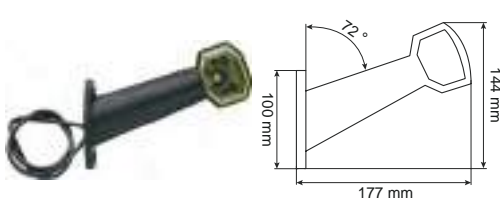

Voltage: 24

 Dim.: 177x144x48 mm  
 Cable length: 700 mm  
 Dist. mount. holes:  
 73 mm

 Type: LED  
 Colour/glass: Red/white  
 Material: Rubber  
 Material/dome: Shockproof plastic  
 Fixing screw: 2  
 Sidemarker: w/  
 Tail light: w/  
 No./LEDs: 2x1  
 RH/LH: RH/LH  
 E-approval: Yes

EL. SPECIFICATIONS		DIMENSIONS		ADDITIONAL SPECIFICATIONS			
<b>171530 LED Tail-Position Lamp</b>		<b>171591 LED Tail-Position Lamp</b>		<b>171592 LED Tail-Position Lamp</b>			
	<p>Voltage: 24</p>	<p>Dim.: 115x65x48 mm Cable length: 700 mm Dist. mount. holes: 73 mm</p>	<p>Type: LED Colour/glass: Red/white Material: Rubber Material/dome: Shockproof plastic Fixing screw: 2 Sidemarker: w/ Tail light: w/ No./LEDs: 2x1 RH/LH: RH/LH E-approval: Yes</p>		<p>Voltage: 9-36</p>	<p>Dim.: 193x162x70 mm Dist. mount. holes: 78 mm</p>	<p>Type: LED Colour/glass: Red/white Sidemarker: w/ Tail light: w/ No./LEDs: 2x3 RH/LH: RH/LH Approvals: ADR/SAE E-approval: Yes</p>
<b>171593 LED Tail-Position Lamp</b>		<b>171617 LED Tail-Position Lamp</b>		<b>171730 LED Tail/Position/Side Marker</b>			
	<p>Voltage: 9-36</p>	<p>Dim.: 184x145x70 mm Dist. mount. holes: 78 mm</p>	<p>Type: LED Colour/glass: Red/white Sidemarker: w/ Tail light: w/ No./LEDs: 2x3 RH/LH: RH/LH Approvals: SAE E-approval: Yes</p>		<p>Voltage: 9-36</p>	<p>Dim.: 75x89x62 mm OD: 45 mm Dist. mount. holes: 78 mm</p>	<p>Type: LED Colour/glass: Red/white Material: Rubber Sidemarker: w/ Tail light: w/ No./LEDs: 2x3 RH/LH: RH/LH Approvals: ADR/SAE E-approval: Yes</p>
<b>171617 LED Tail-Position Lamp</b>		<b>171731 LED Tail/Position/Side Marker</b>		<b>171731 LED Tail/Position/Side Marker</b>			
	<p>Voltage: 9-36</p>	<p>Dim.: 96x76x63 mm OD: 76 mm Dist. mount. holes: 78 mm</p>	<p>Type: LED Colour/glass: Red/white Material: Synthetic rubber Sidemarker: w/ Tail light: w/ No./LEDs: 2x3 RH/LH: RH/LH Approvals: ADR/SAE E-approval: Yes</p>	<p>w/ 128 mm rubber arm. Cover of click-in connector HC-CARGO 172016.</p>	<p>Voltage: 12/24</p>	<p>Dim.: 127.1x100.3 mm Cable length: 500 mm Dist. mount. holes: 78 mm</p>	<p>Type: LED Mount.: 2 screws Sidemarker: w/ Sidemarker lamp: w/ Tail light: w/ No./LEDs: 7 RH/LH: RH/LH Tightness norm: IP 67 E-approval: Yes</p>
<b>171731 LED Tail/Position/Side Marker</b>		<b>171731 LED Tail/Position/Side Marker</b>		<b>171731 LED Tail/Position/Side Marker</b>			
<p>w/ 145 mm rubber arm. Cover of click-in connector HC-CARGO 172016.</p>	<p>Voltage: 12/24</p>	<p>Dim.: 142.2x130.5x40.5 mm Cable length: 450 mm Dist. mount. holes: 52 mm</p>	<p>Type: LED Colour: Black Material: Rubber Mount.: 4 holes Sidemarker: w/ Sidemarker lamp: w/ Tail light: w/ No./LEDs: 9 RH/LH: RH E-approval: Yes</p>				



**171732 LED Tail/Position/Side Marker**

Cover of click-in connector HC-CARGO 172016.

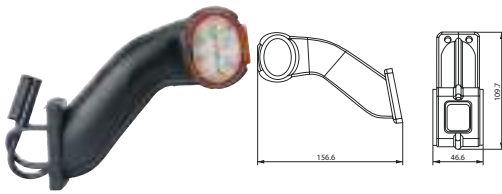

Voltage: 12/24

 Dim.: 142.2x130.5x40.5 mm  
 Cable length: 450 mm  
 Dist. mount. holes: 52 mm

 Type: LED  
 Colour: Black  
 Material: Rubber  
 Mount.: 4 holes  
 Sidemarker: w/  
 Sidemarker lamp: w/  
 Tail light: w/  
 No./LEDs: 9  
 RH/LH: LH  
 E-approval: Yes

**171733 LED Tail/Position/Side Marker**

Cover of click-in connector HC-CARGO 172016.

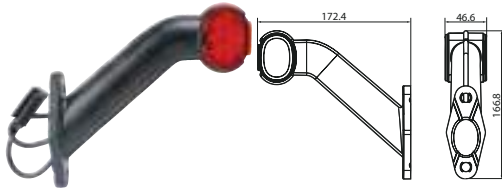

Voltage: 12/24

 Dim.: 172.4x166.8x46.6 mm  
 Cable length: 500 mm  
 Dist. mount. holes: 78 mm

 Type: LED  
 Mount.: 2 screws  
 Sidemarker: w/  
 Sidemarker lamp: w/  
 Tail light: w/  
 No./LEDs: 7  
 RH/LH: RH

**171734 LED Tail/Position/Side Marker**

Cover of click-in connector HC-CARGO 172016.



Voltage: 12/24

 Dim.: 172.4x166.8x46.6 mm  
 Cable length: 500 mm  
 Dist. mount. holes: 78 mm

 Type: LED  
 Mount.: 2 screws  
 Sidemarker: w/  
 Sidemarker lamp: w/  
 Tail light: w/  
 No./LEDs: 7  
 RH/LH: LH

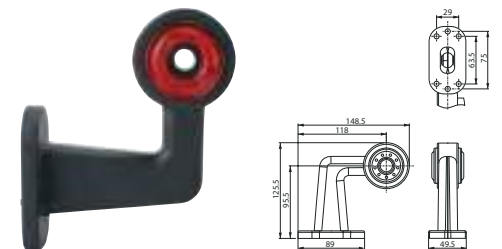
**171958 LED Tail-Position Lamp**

Voltage: 12-24

 Dim.: 148.5x125.5x89 mm  
 Cable length: 300 mm  
 Dist. mount. holes: 63.5/75/29 mm

 Type: LED  
 Colour: Black  
 Colour/glass: Red/white  
 Material: Rubber  
 Material/dome: Shockproof plastic  
 Shape: Round  
 Mount.: 6 screws  
 Sidemarker: w/  
 Tail light: w/  
 RH/LH: RH  
 Tightness norm: IP 68  
 E-approval: Yes

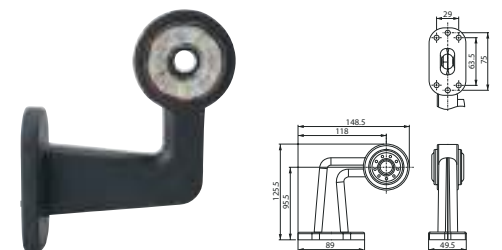
**171959 LED Tail-Position Lamp**

Voltage: 12-24

 Dim.: 148.5x125.5x89 mm  
 Cable length: 300 mm  
 Dist. mount. holes: 63.5/75/29 mm

 Type: LED  
 Colour: Black  
 Colour/glass: Red/white  
 Material: Rubber  
 Material/dome: Shockproof plastic  
 Shape: Round  
 Mount.: 6 screws  
 Sidemarker: w/  
 Tail light: w/  
 RH/LH: LH  
 Tightness norm: IP 68  
 E-approval: Yes

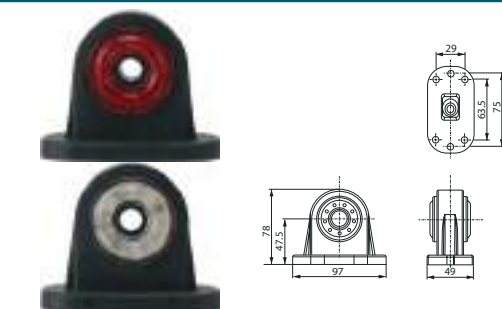
**171960 LED Tail-Position Lamp**

Voltage: 12-24

 Dim.: 97x78x49 mm  
 Cable length: 300 mm  
 Dist. mount. holes: 75/63.5/29 mm

 Type: LED  
 Colour: Black  
 Colour/glass: Red/white  
 Material: Rubber  
 Material/dome: Shockproof plastic  
 Shape: Round  
 Mount.: 6 screws  
 Sidemarker: w/  
 Tail light: w/  
 RH/LH: RH/LH  
 Tightness norm: IP 68  
 E-approval: Yes

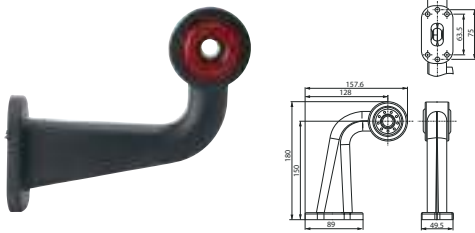
**171961 LED Tail-Position Lamp**

**Voltage:** 12-24

**Dim.:** 180x157.6x89 mm  
**Cable length:** 300 mm  
**Dist. mount. holes:** 75/63.5/29 mm

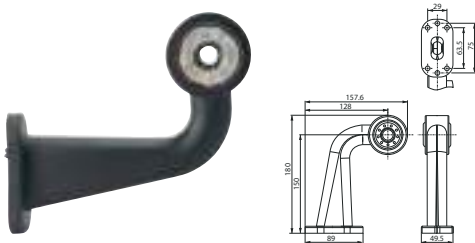
**Type:** LED  
**Colour:** Black  
**Colour/glass:** Red/white  
**Material:** Rubber  
**Material/dome:** Shockproof plastic  
**Shape:** Round  
**Mount.:** 6 screws  
**Sidemarkers:** w/  
**Tail light:** w/  
**RH/LH:** RH  
**Tightness norm:** IP 68  
**E-approval:** Yes

**171962 LED Tail-Position Lamp**

**Voltage:** 12-24

**Dim.:** 180x157.6x89 mm  
**Cable length:** 300 mm  
**Dist. mount. holes:** 75/63.5/29 mm

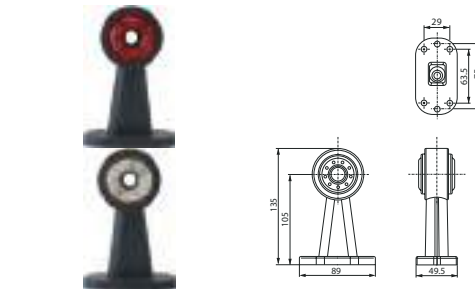
**Type:** LED  
**Colour:** Black  
**Colour/glass:** Red/white  
**Material:** Rubber  
**Material/dome:** Shockproof plastic  
**Shape:** Round  
**Mount.:** 6 screws  
**Sidemarkers:** w/  
**Tail light:** w/  
**RH/LH:** LH  
**Tightness norm:** IP 68  
**E-approval:** Yes

**171963 LED Tail-Position Lamp**

**Voltage:** 12-24

**Dim.:** 135x89x49.5 mm  
**Cable length:** 300 mm  
**Dist. mount. holes:** 75/63.5/29 mm

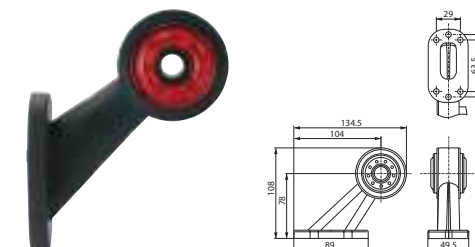
**Type:** LED  
**Colour:** Black  
**Colour/glass:** Red/white  
**Material:** Rubber  
**Material/dome:** Shockproof plastic  
**Shape:** Round  
**Mount.:** 6 screws  
**Sidemarkers:** w/  
**Tail light:** w/  
**RH/LH:** RH/LH  
**Tightness norm:** IP 68  
**E-approval:** Yes

**171964 LED Tail-Position Lamp**

**Voltage:** 12-24

**Dim.:** 134.5x108x89 mm  
**Cable length:** 300 mm  
**Dist. mount. holes:** 75/63.5/29 mm

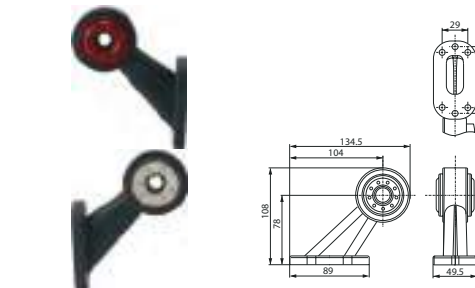
**Type:** LED  
**Colour:** Black  
**Colour/glass:** Red/white  
**Material:** Rubber  
**Material/dome:** Shockproof plastic  
**Shape:** Round  
**Mount.:** 6 screws  
**Sidemarkers:** w/  
**Tail light:** w/  
**RH/LH:** RH  
**Tightness norm:** IP 68  
**E-approval:** Yes

**171965 LED Tail-Position Lamp**

**Voltage:** 12-24

**Dim.:** 134.5x108x89 mm  
**Cable length:** 300 mm  
**Dist. mount. holes:** 75/63.5/29 mm

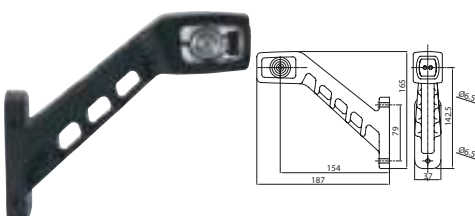
**Type:** LED  
**Colour:** Black  
**Colour/glass:** Red/white  
**Material:** Rubber  
**Material/dome:** Shockproof plastic  
**Shape:** Round  
**Mount.:** 6 screws  
**Sidemarkers:** w/  
**Tail light:** w/  
**RH/LH:** LH  
**Tightness norm:** IP 68  
**E-approval:** Yes

**171966 LED Tail/Position/Side Marker**

**Voltage:** 12-24

**Dim.:** 187x165x37 mm  
**Cable length:** 300 mm  
**Dist. mount. holes:** 79 mm

**Type:** LED  
**Colour:** Black  
**Colour/glass:** Transparent  
**Material:** Rubber  
**Material/dome:** Shockproof plastic  
**Mount.:** 2 screws  
**Sidemarkers:** w/  
**Sidemarkers lamp:** w/  
**Tail light:** w/  
**RH/LH:** RH  
**Tightness norm:** IP 68  
**E-approval:** Yes

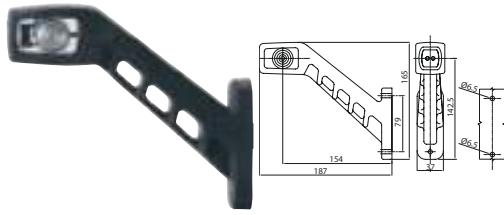
**171967** LED Tail/Position/Side Marker



Voltage: 12-24

Dim.: 187x165x37 mm  
Cable length: 300 mm  
Dist. mount. holes:  
79 mm

Type: LED  
Colour: Black  
Colour/glass: Transparent  
Material: Rubber  
Material/dome: Shockproof plastic  
Mount.: 2 screws  
Sidemarker: w/  
Sidemarker lamp: w/  
Tail light: w/  
RH/LH: LH  
Tightness norm: IP 68  
E-approval: Yes

**171968** LED Tail/Position/Side Marker

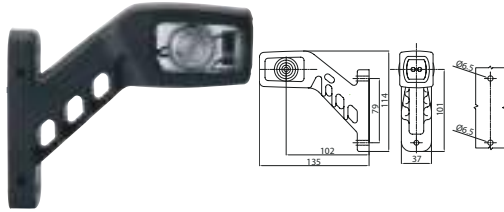

Voltage: 12-24

Dim.: 135x114x37 mm  
Cable length: 300 mm  
Dist. mount. holes:  
79 mm

Type: LED  
Colour: Black  
Colour/glass: Transparent  
Material: Rubber  
Material/dome: Shockproof plastic  
Mount.: 2 screws  
Sidemarker: w/  
Sidemarker lamp: w/  
Tail light: w/  
RH/LH: RH  
Tightness norm: IP 68  
E-approval: Yes

**171969** LED Tail/Position/Side Marker

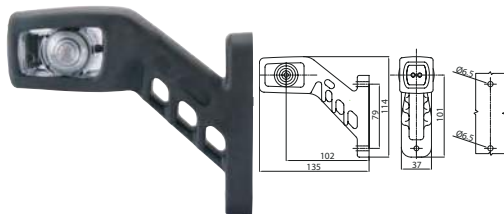

Voltage: 12-24

Dim.: 135x114x37 mm  
Cable length: 300 mm  
Dist. mount. holes:  
79 mm

Type: LED  
Colour: Black  
Colour/glass: Transparent  
Material: Rubber  
Material/dome: Shockproof plastic  
Mount.: 2 screws  
Sidemarker: w/  
Sidemarker lamp: w/  
Tail light: w/  
RH/LH: LH  
Tightness norm: IP 68  
E-approval: Yes

**171970** LED Tail/Position/Side Marker

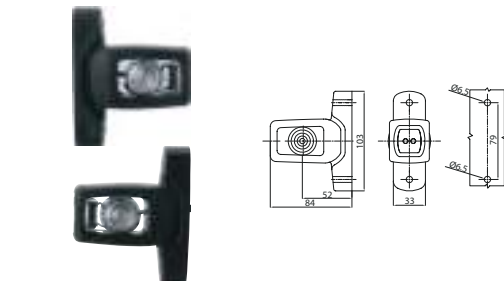

Voltage: 12-24

Dim.: 103x84x33 mm  
Cable length: 300 mm  
Dist. mount. holes:  
79 mm

Type: LED  
Colour: Black  
Colour/glass: Transparent  
Material: Rubber  
Material/dome: Shockproof plastic  
Mount.: 2 screws  
Sidemarker: w/  
Sidemarker lamp: w/  
Tail light: w/  
RH/LH: RH/LH  
Tightness norm: IP 68  
E-approval: Yes

**WARNING LIGHTS**

**FLASH LIGHTS LED**

**171642** LED Flash, white

Multi-module synchronization. Bracket: HC-CARGO 171657. Rubber adapter for flush mount: HC-CARGO 171728.

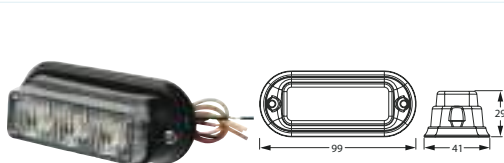

Voltage: 12/24

Length: 99 mm  
Height: 29 mm  
Width: 41 mm

Bulb type: LED  
Colour: White  
Model: 3 LED  
Flash patterns: 12  
Waterproof: Yes  
Approvals: CE/EMC

**171644** LED Flash, blue

Multi-module synchronization. Bracket: HC-CARGO 171657. Rubber adapter for flush mount: HC-CARGO 171728.

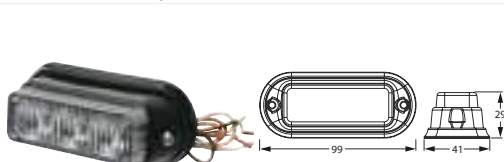

Voltage: 12/24

Length: 99 mm  
Height: 29 mm  
Width: 41 mm

Bulb type: LED  
Colour: Blue  
Model: 3 LED  
Flash patterns: 12  
Waterproof: Yes  
Approvals: CE/EMC

**171646 LED Flash, white**

Multi-module synchronization. Bracket: HC-CARGO 171658. Rubber adapter for flush mount: HC-CARGO 171675.

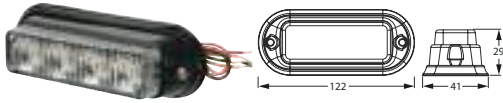

Voltage: 12/24

Length: 122 mm  
Height: 29 mm  
Width: 41 mm

Bulb type: LED  
Colour: White  
Model: 4 LED  
Flash patterns: 19  
Waterproof: Yes  
Approvals: CE/EMC

**171648 LED Flash, blue**

Multi-module synchronization. Bracket: HC-CARGO 171658. Rubber adapter for flush mount: HC-CARGO 171675.

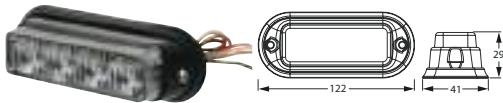

Voltage: 12/24

Length: 122 mm  
Height: 29 mm  
Width: 41 mm

Bulb type: LED  
Colour: Blue  
Model: 4 LED  
Flash patterns: 19  
Waterproof: Yes  
Approvals: CE/EMC

**171661 LED Flash, amber**

Multi-module synchronization. Bracket: HC-CARGO 171663.



Voltage: 12/24  
Amp: 0.52

Length: 116 mm  
Cable length: 200 mm  
Height: 23.8 mm  
Width: 47 mm

Bulb type: LED  
Lens type: Frosted  
Colour: Orange  
Model: 4 LED  
Flash patterns: 12  
Waterproof: Yes  
Approvals: SAE/CE  
E-approval: No

**171662 LED Flash, amber**

Multi-module synchronization. Bracket: HC-CARGO 171664.

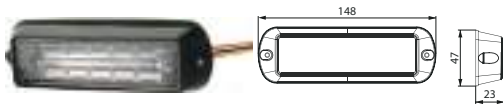

Voltage: 12/24  
Amp: 0.46/0.24  
Watt: 6

Length: 148 mm  
Cable length: 200 mm  
Height: 23 mm  
Width: 47 mm

Bulb type: LED  
Lens type: Transparent  
Colour: Orange  
Model: 6 LED  
Flash patterns: 19  
Waterproof: Yes  
Approvals: SAE/CE  
E-approval: No

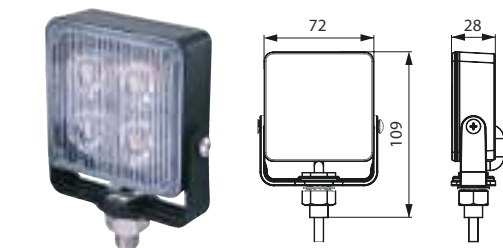
**171746 LED Flash, amber**

Voltage: 12/24  
Amp: 0.27-0.13  
Watt: 3.5

Length: 109 mm  
Cable length: 1200 mm  
Height: 28 mm  
Width: 72 mm

Bulb type: LED  
Lens type: Transparent  
Colour: Orange  
Material: Cast aluminum  
Flash patterns: 19  
Hi impact: Yes  
Coiled cable incl.: No  
Waterproof: Yes  
Approvals: SAE/CE

**171813 LED Flash, blue**

Fits w/ rubber adapter for flush mount: HC-CARGO 171817.

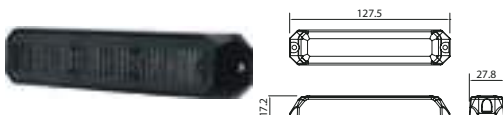

Voltage: 12/24

Length: 127.5 mm  
Cable length: 200 mm  
Height: 17.2 mm  
Width: 27.8 mm

Bulb type: LED  
Colour: Blue  
Model: 6 LED  
Flash patterns: 5  
Waterproof: Yes  
Approvals: SAE/ECE-R65  
E-approval: Yes

**171814** LED Flash, amber

*Fits w/ rubber adapter for flush mount: HC-CARGO 171817.*

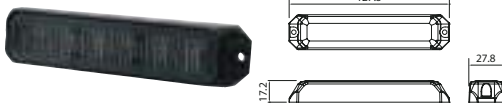

Voltage: 12/24  
Amp: 0.39/0.20  
Watt: 0.48

Length: 127.5 mm  
Cable length: 970 mm  
Height: 17.2 mm  
Width: 27.8 mm

Bulb type: LED  
Colour: Orange  
Model: 6 LED  
Flash patterns: 5  
Waterproof: Yes  
Approvals: SAE/ECE-R65  
E-approval: Yes

**171815** LED Flash, amber

*For HC-CARGO 171816.*

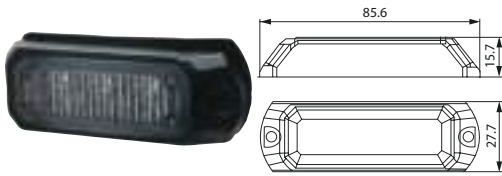

Voltage: 12/24  
Amp: 0.2/0.1

Length: 85.6 mm  
Cable length: 200 mm  
Height: 15.7 mm  
Width: 27.7 mm

Bulb type: LED  
Colour: Orange  
Model: 3 LED  
Flash patterns: 12  
Waterproof: Yes  
Approvals: SAE J595/ECE-R10  
E-approval: Yes

**171904** LED Flash, amber

*Multi-module synchronization. Bracket: HC-CARGO 171658. Rubber adapter for flush mount: HC-CARGO 171675.*

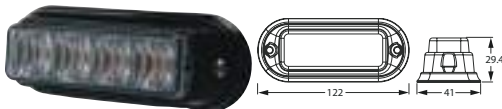

Voltage: 12-24  
Amp: 0.32/0.17  
Watt: 4.1

Length: 122 mm  
Cable length: 200 mm  
Height: 29.4 mm  
Width: 41 mm

Bulb type: LED  
Colour: Orange  
Model: 4 LED  
Flash patterns: 23  
Waterproof: Yes  
Approvals: SAE/ECE-R65  
E-approval: Yes

**171905** LED Flash, amber

*Multi-module synchronization. Bracket: HC-CARGO 171657. Rubber adapter for flush mount: HC-CARGO 171728.*

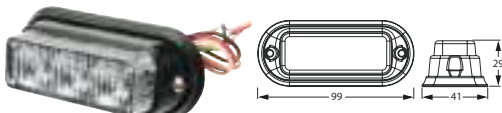

Voltage: 12-24  
Amp: 0.32/0.16

Length: 99 mm  
Cable length: 200 mm  
Height: 29 mm  
Width: 41 mm

Bulb type: LED  
Colour: Orange  
Model: 3 LED  
Flash patterns: 12  
Waterproof: Yes  
Approvals: SAE/ECE-R65  
E-approval: Yes

**171906** LED Flash, amber

*Multi-module synchronization. Bracket: HC-CARGO 171908. Rubber adapter for flush mount: HC-CARGO 171907.*



Voltage: 12-24  
Amp: 0.75/0.38  
Watt: 9

Length: 131.8 mm  
Cable length: 200 mm  
Height: 48.7 mm  
Width: 19.2 mm

Bulb type: 12 LED  
Colour: Orange  
Flash patterns: 25  
Waterproof: Yes  
Approvals: SAE/ECE-R65  
E-approval: Yes

**171926** LED Flash, amber

*Fits w/ rubber adapter for flush mount: HC-CARGO 171817.*



Voltage: 12-24  
Amp: 0.39/0.20

Length: 127.5 mm  
Cable length: 3000 mm  
Height: 17.2 mm  
Width: 27.8 mm

Bulb type: LED  
Colour: Orange  
Model: 6 LED  
Mount.: 3 m ADR Cable  
Flash patterns: 5  
Waterproof: Yes  
Approvals: SAE/ECE-R65  
E-approval: Yes



**171933** LED Flash, amber

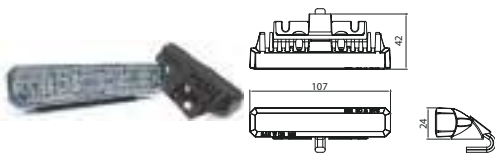

Voltage: 12-24  
Amp: 0.55/0.26

Length: 107 mm  
Cable length: 970 mm  
Height: 24 mm  
Width: 42 mm

Bulb type: LED  
Colour: Orange  
Model: 6 LED  
Mount.: Plan  
Flash patterns: 19  
Waterproof: Yes  
Approvals: SAE/ECE-R65  
E-approval: Yes

**171934** LED Flash, blue

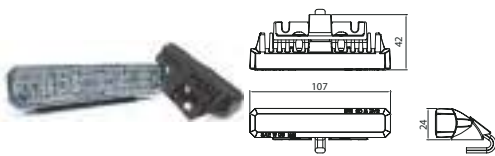

Voltage: 11-30

Length: 107 mm  
Height: 24 mm  
Width: 42 mm

Bulb type: LED  
Colour: Blue  
Model: 6 LED  
Mount.: Plan  
Flash patterns: 5  
Waterproof: Yes  
Approvals: SAE/ECE-R65  
E-approval: Yes

**171943** LED Flash, white

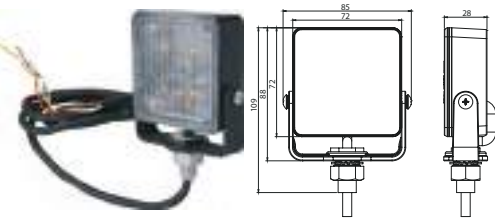

Voltage: 12/24  
Amp: 0.27-0.13  
Watt: 3.5

Length: 109 mm  
Cable length: 1200 mm  
Height: 28 mm  
Width: 72 mm

Bulb type: LED  
Lens type: Transparent  
Colour: White  
Material: Aluminium  
Flash patterns: 19  
Hi impact: Yes  
Coiled cable incl.: No  
Waterproof: Yes  
Approvals: SAE/CE

**172011** LED Flash, amber

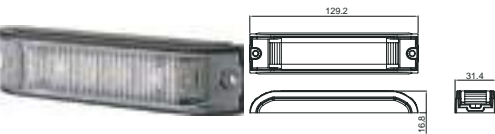

Voltage: 12/24  
Amp: 0.5/0.25  
Watt: 6

Length: 129.2 mm  
Cable length: 250 mm  
Height: 31.4 mm  
Width: 16.8 mm

Bulb type: 6 LED  
Colour: Orange  
Flash patterns: 15  
Waterproof: Yes  
Approvals: ECE-R65  
E-approval: Yes

**172012** LED Flash, amber

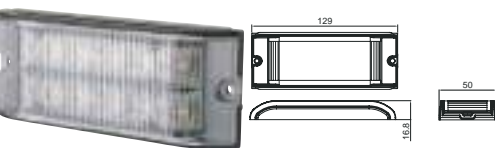

Voltage: 12/24  
Amp: 0.88/0.44  
Watt: 10.5

Length: 129 mm  
Cable length: 250 mm  
Height: 16.8 mm  
Width: 50 mm

Bulb type: LED  
Colour: Orange  
Model: 12 LED  
Flash patterns: 15  
Waterproof: Yes  
Approvals: ECE-R65  
E-approval: Yes

**172013** LED Flash, amber

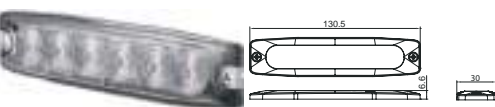

Voltage: 12/24  
Amp: 0.25/0.125  
Watt: 3

Length: 130.5 mm  
Cable length: 200 mm  
Height: 6.6 mm  
Width: 30 mm

Bulb type: 6 LED  
Colour: Orange  
Flash patterns: 23  
Waterproof: Yes  
Approvals: SAE/CE  
E-approval: Yes

**172076** LED Flash, amber

Multi-module synchronization. Bracket: HC-CARGO 171908. Rubber adapter for flush mount: HC-CARGO 171907.

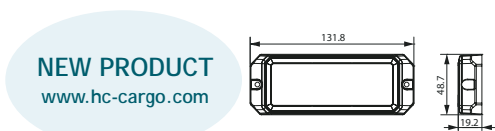

**NEW PRODUCT**  
[www.hc-cargo.com](http://www.hc-cargo.com)

Voltage: 12-24  
Amp: 0.75/0.38  
Watt: 9

Length: 131.8 mm  
Cable length: 2000 mm  
Height: 48.7 mm  
Width: 19.2 mm

Bulb type: 12 LED  
Colour: Orange  
Flash patterns: 25  
Waterproof: Yes  
Approvals: SAE/ECE-R65  
E-approval: Yes

**172085** LED Flash, amber

**NEW PRODUCT**  
www.hc-cargo.com

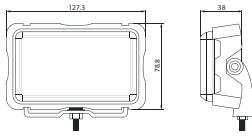

Voltage: 12-36  
Amp: 1.5/0.8

Length: 127.3 mm  
Cable length: 1800 mm  
Height: 78.8 mm  
Width: 38 mm

Bulb type: 6 LED  
Colour: Orange  
Material: Aluminium  
Tightness norm: IP 67  
Approvals: ECE-R10/ECE-R65  
E-approval: Yes

**172086** LED Flash, amber

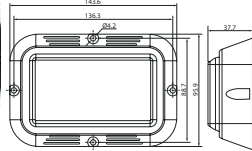

Voltage: 12-36  
Amp: 1.5/0.8

Length: 143.6 mm  
Cable length: 1800 mm  
Height: 95.9 mm  
Width: 37.7 mm

Bulb type: 6 LED  
Colour: Orange  
Material: Aluminium  
Mount.: Plan  
Tightness norm: IP 67  
Approvals: ECE-R10/ECE-R65  
E-approval: Yes

**172087** LED Flash, amber

Rubber Adapter for Flush Mount: HC-CARGO 171816.

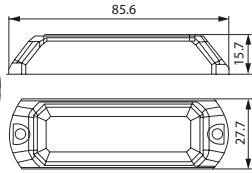

Voltage: 12-24

Length: 85.6 mm  
Height: 15.7 mm  
Width: 27.7 mm

Bulb type: 3 LED  
Colour: Orange  
Flash patterns: 12  
Waterproof: Yes  
Approvals: SAE/ECE-R65  
E-approval: Yes

**172089** LED Safety Flash

With hook. Battery: 3x HC-CARGO 200738.

**NEW PRODUCT**  
www.hc-cargo.com

OD: 105 mm  
Height: 35 mm

Colour: Orange  
Model: 12 LED  
Mount.: 1 magnet  
Flash patterns: 9  
Tightness norm: IP 67  
Approvals: CE/EMC

**172090** LED Safety Flash

Rechargeable.

**NEW PRODUCT**  
www.hc-cargo.com

Voltage: 12  
Amp: 1.5

OD: 120 mm  
Height: 35 mm

Colour: Orange  
Model: 16 LED  
Mount.: 1 magnet  
Flash patterns: 9  
Tightness norm: IP 67  
Approvals: CE/EMC

**172091** LED Safety Flash

Rechargeable. Suitcase w/ 6 pcs.

**NEW PRODUCT**  
www.hc-cargo.com

Voltage: 12  
Amp: 1.5

OD: 120 mm  
Height: 35 mm

Colour: Orange  
Model: 16 LED  
Mount.: 1 magnet  
Flash patterns: 9  
Tightness norm: IP 67  
Approvals: CE/EMC

**ACCESSORIES**





**171657** Mounting Bracket

Servicing: HC-CARGO 171642, 171644, 171905

Angled. For single head.

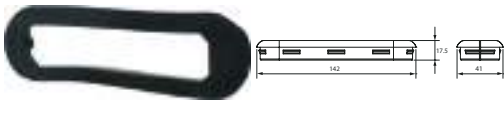

Length: 100 mm  
Thickness: 24 mm  
Width: 55 mm

EL. SPECIFICATIONS		DIMENSIONS	ADDITIONAL SPECIFICATIONS
<b>171658</b> Mounting Bracket <i>Angled. For single head.</i>		Servicing: HC-CARGO 171646, 171648 	
		Length: 123 mm Thickness: 55 mm Width: 24 mm	
<b>171663</b> Mounting Bracket <i>Angled 100°.</i>		Servicing: HC-CARGO 171661 	
		Length: 153 mm Thickness: 55 mm Width: 25 mm	
<b>171664</b> Mounting Bracket <i>Adjustable.</i>		Servicing: HC-CARGO 171662 	
		Length: 156 mm Thickness: 42 mm Width: 30 mm	
<b>171675</b> Rubber Adapter for Flush Mount		Servicing: HC-CARGO 171646, 171648 	
		Length: 114.4 mm Height: 24.9 mm Width: 40 mm	Colour: Black Material: Rubber
<b>171728</b> Rubber Adapter for Flush Mount		Servicing: HC-CARGO 171641, 171642, 171644 	
		Length: 92 mm Height: 25.2 mm Width: 40 mm	Colour: Black Material: Rubber
<b>171816</b> Rubber Adapter for Flush Mount		Servicing: HC-CARGO 171815, 172087 	
		Length: 100.6 mm Height: 15.7 mm Width: 38 mm	Colour: Black Material: Rubber
<b>171817</b> Rubber Adapter for Flush Mount		Servicing: HC-CARGO 171813, 171814 	
		Length: 142 mm Height: 17.5 mm Width: 41 mm	Colour: Black Material: Rubber

**171907** Rubber Adapter for Flush Mount

Servicing: HC-CARGO 171906

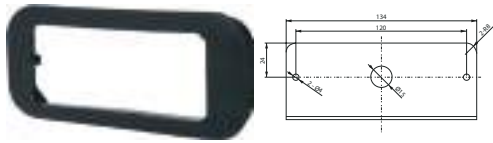

Length: 144 mm  
Height: 61 mm  
Width: 20 mm

Colour: Black  
Material: Rubber

**171908** Mounting Bracket

Servicing: HC-CARGO 171906

Angled. For single head.



**LIGHT BARS CONVENTIONAL**

**171681** Mini Light Bar



Bulb incl.: Yes  
12 V  
Voltage: 12/24

Length: 400 mm  
Height: 134 mm  
Width: 180 mm

Bulb type: H1 12 V  
Lens type: Polycarbonate  
Colour: Orange  
Material: ABS plastic  
Mount.: Plan  
Base: Rigid  
Hi impact: Yes  
Coiled cable incl.: No  
Waterproof: Yes  
Tightness norm: IP 56  
Approvals: CE  
E-approval: Yes

**LIGHT BARS LED**

**171680** LED Mini Light Bar

Bracket for permanent mounting: HC-CARGO 171682. Change flash pattern on cigarplug. Can also be connected permanently.



Voltage: 12/24  
Amp: 2.6/1.36  
Watt: 33.3

Length: 422 mm  
Cable length: 4570 mm  
Height: 65 mm  
Width: 278 mm

Bulb type: 40x1W LED  
Lens type: Polycarbonate  
Colour: Orange  
Model: FALCON  
Mount.: Plan  
Base: Magnetic/vacuum  
Flash patterns: 26  
Hi impact: Yes  
Waterproof: Yes  
Tightness norm: IP 64K  
Approvals: SAE/CE  
E-approval: No

**171851** LED Light bar

Spare Parts: HC-CARGO 171857, 171859. Accessories: HC-CARGO 171865, 171762. Recommended fuse 15 A.

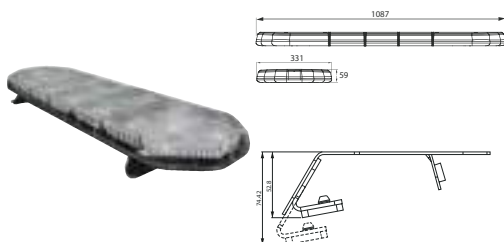

Voltage: 24  
Amp: 15

Length: 1087 mm  
Cable length: 5750 mm  
Height: 59 mm  
Width: 331 mm

Lens type: Polycarbonate  
Colour: Orange  
Material: Aluminium  
Model: 110 cm/43"  
Mount.: Plan  
Base: Flexible  
Flash patterns: 21  
Hi impact: Yes  
Waterproof: Yes  
Tightness norm: IP 64K  
Approvals: SAE/ECE-R65  
E-approval: Yes

**171853 LED Light bar**

Spare Parts: HC-CARGO 171857, 171859. Accessories: HC-CARGO 171865, 171762. Recommended fuse 15 A.

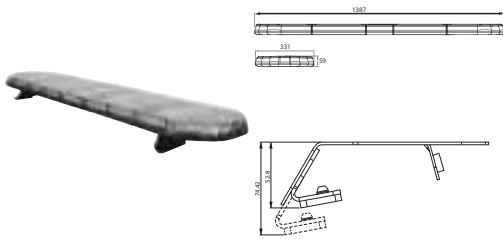

Voltage: 24  
Amp: 17

Length: 1387 mm  
Cable length: 5750 mm  
Height: 59 mm  
Width: 331 mm

Lens type: Polycarbonate  
Colour: Orange  
Material: Aluminium  
Model: 140 cm/54"  
Mount.: Plan  
Base: Flexible  
Flash patterns: 21  
Hi impact: Yes  
Waterproof: Yes  
Tightness norm: IP 64K  
Approvals: SAE/ECE-R65  
E-approval: Yes

**171854 LED Micro Light Bar**

Bracket for permanent mounting: HC-CARGO 171855. Change flash pattern on cigarplug. Can also be connected permanently.

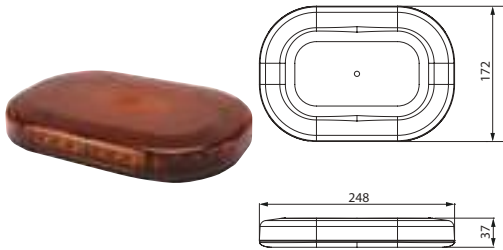

Voltage: 12/24  
Amp: 4.2/1.05

OD: 248x172 mm  
Length: 248 mm  
Cable length: 3000 mm  
Height: 37 mm  
Width: 172 mm

Bulb type: 30x1 W LED  
Lens type: Polycarbonate  
Colour: Orange  
Mount.: Plan  
Base: Magnetic  
Flash patterns: 23  
Hi impact: Yes  
Waterproof: Yes  
Tightness norm: IP 64K  
Approvals: SAE/ECE-R65  
E-approval: Yes

**171911 LED Light bar**

Spare Parts: HC-CARGO 171857, 171859. Accessories: HC-CARGO 171865, 171762. Recommended fuse 15 A.

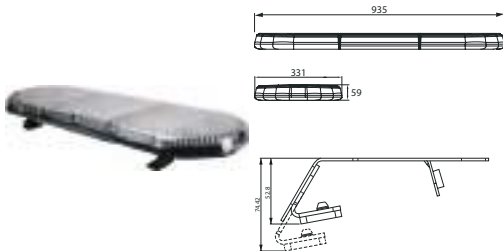

Voltage: 24  
Amp: 8

Length: 935 mm  
Cable length: 5750 mm  
Height: 59 mm  
Width: 331 mm

Lens type: Polycarbonate  
Colour: Orange  
Material: Aluminium  
Model: 91.4cm - 36"  
Mount.: Plan  
Base: Flexible  
Flash patterns: 21  
Hi impact: Yes  
Waterproof: Yes  
Tightness norm: IP 64K  
Approvals: SAE/ECE-R65  
E-approval: Yes

**171913 LED Light bar**

Spare Parts: HC-CARGO 171857, 171859. Accessories: HC-CARGO 171865, 171762. Recommended fuse 15 A.

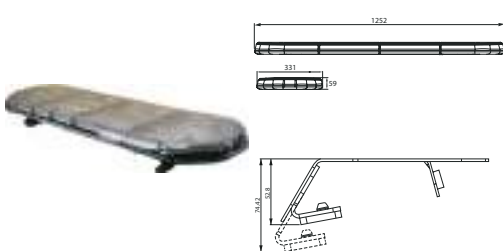

Voltage: 24  
Amp: 16

Length: 1252 mm  
Cable length: 5750 mm  
Height: 59 mm  
Width: 331 mm

Lens type: Polycarbonate  
Colour: Orange  
Material: Aluminium  
Model: 124.5 cm/49"  
Mount.: Plan  
Base: Flexible  
Flash patterns: 21  
Hi impact: Yes  
Waterproof: Yes  
Tightness norm: IP 64K  
Approvals: SAE/ECE-R65  
E-approval: Yes

**171914 LED Light bar**

Spare Parts: HC-CARGO 171857, 171859. Accessories: HC-CARGO 171865, 171762. Recommended fuse 20 A.

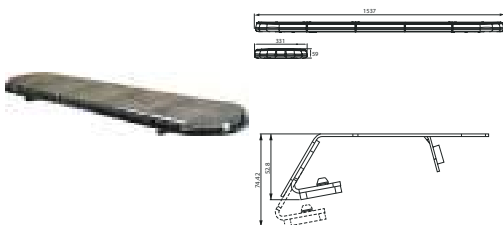

Voltage: 24  
Amp: 18

Length: 1524 mm  
Cable length: 5750 mm  
Height: 59 mm  
Width: 331 mm

Lens type: Polycarbonate  
Colour: Orange  
Material: Aluminium  
Model: 152.4 cm/60"  
Mount.: Plan  
Base: Flexible  
Flash patterns: 21  
Hi impact: Yes  
Waterproof: Yes  
Tightness norm: IP 64K  
Approvals: SAE/ECE-R65  
E-approval: Yes



**172094 LED Mini Light Bar**

Switch Panel: HC-CARGO 171762.



Voltage: 12/24  
Amp: 2.88/1.44  
Watt: 34.5

Length: 355 mm  
Cable length: 3000 mm  
Height: 53 mm  
Width: 205 mm

Bulb type: 24 LED  
Lens type: Polycarbonate  
Colour: Orange  
Material: Shockproof plastic  
Mount.: Screw  
Flash patterns: 23  
Waterproof: Yes  
Tightness norm: IP 64K  
Approvals: EMC-R10/ECE-R65  
E-approval: Yes

**ACCESSORIES**

**171682 Mounting Bracket for LED Mini Light Bar**

Servicing: HC-CARGO 171680



Thickness: 3 mm  
Dist. mount. holes: 212 mm

**171855 Mounting Bracket for LED Micro Light Bar**

Servicing: HC-CARGO 171854

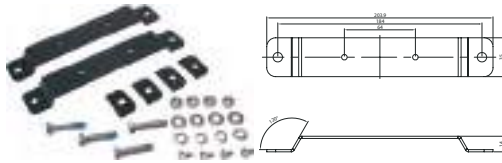

Total length: 203.9 mm  
Height: 14 mm  
Dist. mount. holes: 64/184 mm  
Width: 35 mm

**171857 LED Flash, amber**

Servicing: HC-CARGO 171851, 171853, 171911, 171913, 171914

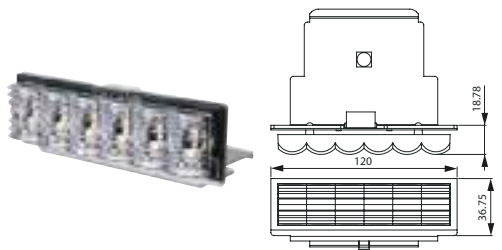

Voltage: 24

Length: 120 mm  
Height: 36.75 mm  
Width: 18.78 mm

Bulb type: 6 LED  
Colour: Orange  
Approvals: SAE/ECE-R65  
E-approval: Yes

**171859 LED Corner Flash, orange**

Servicing: HC-CARGO 171851, 171853, 171911, 171913, 171914

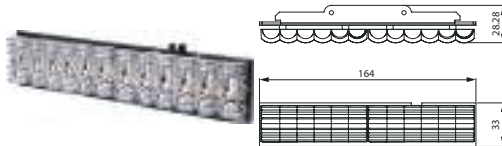

Voltage: 24

Length: 164 mm  
Height: 33 mm  
Width: 28.28 mm

Bulb type: 12 LED  
Colour: Orange  
Approvals: SAE/ECE-R65  
E-approval: Yes

**171865 LED Alley Light**

Servicing: HC-CARGO 171851, 171853, 171911, 171913, 171914

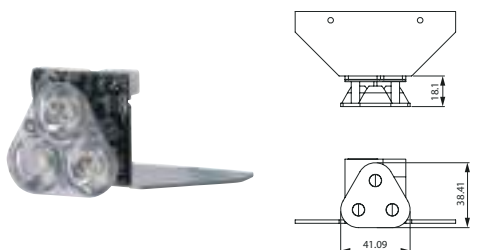

Voltage: 24

Height: 38.41 mm

Bulb type: 3 LED  
Approvals: SAE/ECE-R65  
E-approval: Yes

## ROTATING BEACONS CONVENTIONAL

### 170296 Rotating Beacon

Lens: HC-CARGO 170308. Motor: HC-CARGO 170506. Plastic base plate: HC-CARGO 170309.

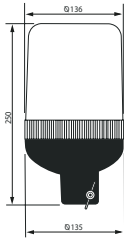

Bulb incl.: Yes  
Voltage: 24

OD: 136 mm  
Height: 250 mm  
Width: 135.5 mm

Bulb type: H1  
Lens type: PMMA/ACRYL  
Colour: Orange  
Model: AEB TYPE 590  
Mount.: Standard ISO A - Rod  
E-approval: Yes

### 170436 Rotating Beacon

Lens: HC-CARGO 170308. Motor: HC-CARGO 170506.

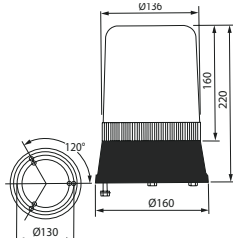

Bulb incl.: Yes  
Voltage: 24

OD: 160 mm  
Height: 220 mm

Bulb type: H1  
Lens type: Amber dome  
Colour: Orange  
Model: AEB TYPE 595  
Mount.: Standard ISO B2 (and B1) - Base  
E-approval: Yes

### 170438 Rotating Beacon

Lens: HC-CARGO 170308. Motor: HC-CARGO 170505. Coil cable: length 2 m.

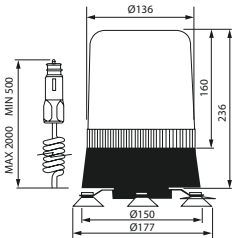

Bulb incl.: Yes  
Voltage: 24

OD: 177 mm  
Height: 236 mm

Bulb type: H1  
Lens type: PMMA/ACRYL  
Colour: Orange  
Model: AEB TYPE 595 M  
Mount.: 3 magnets  
Base: Magnetic  
Coiled cable incl.: Yes  
E-approval: Yes

### 170490 Rotating Beacon

Lens: HC-CARGO 170492.

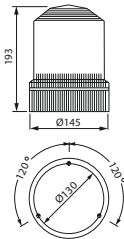

Bulb incl.: No  
Voltage: 12/24

OD: 145 mm  
Height: 193 mm  
Width: 145 mm

Bulb type: H1  
Lens type: PMMA/ACRYL  
Colour: Orange  
Model: TYPE FT 6  
Mount.: Standard ISO B2 (and B1) - Base  
Tightness norm: IP 55  
E-approval: Yes

### 170491 Rotating Beacon

Lens: HC-CARGO 170492.

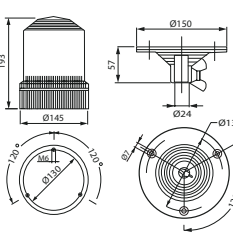

Bulb incl.: No  
Voltage: 12/24

Height: 250 mm

Bulb type: H1  
Lens type: PMMA/ACRYL  
Colour: Orange  
Model: TYPE FT 6  
Mount.: Standard ISO-DIN A or B fixing  
Base: Rigid  
Tightness norm: IP 55  
E-approval: Yes

### 170541 Rotating Beacon

Lens: HC-CARGO 170543.

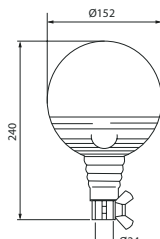

Bulb incl.: Yes  
Voltage: 24

OD: 152 mm  
Height: 240 mm  
Width: 152 mm

Bulb type: H1  
Lens type: Polycarbonate  
Colour: Orange  
Model: Boule  
Mount.: Rod (ISO-DIN A)  
Base: Flexible  
Hi impact: Yes  
Tightness norm: IP 66  
E-approval: Yes

**170598 Rotating Beacon**

Lens: HC-CARGO 170691.

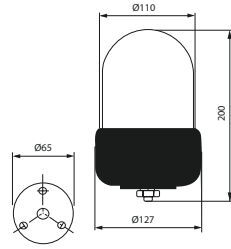

Bulb incl.: No  
Voltage: 12/24

OD: 127 mm  
Height: 200 mm

Bulb type: H1  
Lens type: PMMA/ACRYL  
Colour: Orange  
Model: AEB TYPE 525  
Mount.: Single bolt  
E-approval: Yes

**170599 Rotating Beacon**

Lens: HC-CARGO 170691.

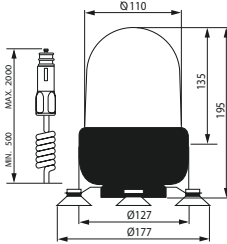

Bulb incl.: No  
Voltage: 12/24

OD: 127 mm  
Cable length: 2000 mm  
Height: 195 mm

Bulb type: H1  
Lens type: PMMA/ACRYL  
Colour: Orange  
Model: AEB TYPE 525 M  
Mount.: 3 magnets  
Base: Magnetic  
Coiled cable incl.: Yes  
E-approval: Yes

**170601 Rotating Beacon**

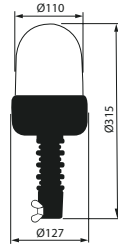

Bulb incl.: No  
Voltage: 12/24

OD: 127 mm  
Height: 315 mm

Bulb type: H1  
Lens type: Polycarbonate  
Colour: Orange  
Model: AEB TYPE 530 B  
Mount.: Standard ISO A - Rod  
Base: Flexible  
Hi impact: Yes  
E-approval: Yes

**170798 Rotating Beacon**

Lens: HC-CARGO 170366. Motor: HC-CARGO 170505, 170506.

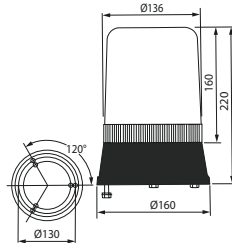

Bulb incl.: No  
Voltage: 12/24

OD: 160 mm  
Height: 220 mm

Bulb type: H1  
Lens type: PMMA/ACRYL  
Colour: Blue  
Model: AEB TYPE 595  
Mount.: Standard ISO B2 (and B1) - Base  
E-approval: Yes

**170830 Rotating Beacon**

Lens: HC-CARGO 170945.

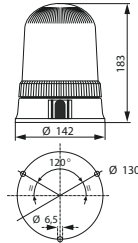

Bulb incl.: No  
Voltage: 12/24

OD: 142 mm  
Height: 183 mm  
Width: 142 mm

Bulb type: H1  
Lens type: PMMA/ACRYL  
Colour: Orange  
Mount.: Standard ISO B2 (and B1) - Base  
E-approval: Yes

**171019 Rotating Beacon**

Lens: HC-CARGO 170945.

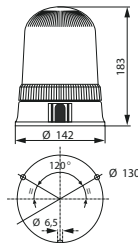

Bulb incl.: No  
Voltage: 12/24

OD: 142 mm  
Height: 183 mm

Bulb type: H1  
Lens type: PMMA/ACRYL  
Colour: Blue  
Model: Astral  
Mount.: Standard ISO B2 (and B1) - Base  
E-approval: Yes

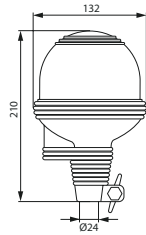
**171061 Rotating Beacon**

Bulb incl.: Yes  
Voltage: 24

OD: 132 mm  
Height: 210 mm

Bulb type: H1  
Lens type: Polycarbonate  
Colour: Orange  
Model: Megalux  
Mount.: Standard ISO A - Rod  
Base: Flexible  
Hi impact: Yes  
E-approval: Yes

**171399 Rotating Beacon**

Lens: HC-CARGO 170308. Motor: HC-CARGO 170505, 170506.

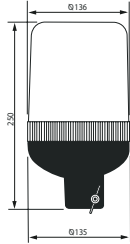

Bulb incl.: No  
Voltage: 12/24

OD: 136 mm  
Height: 250 mm

Bulb type: H1  
Lens type: PMMA/ACRYL  
Colour: Orange  
Model: 590 DVO  
Mount.: Standard ISO A - Rod  
E-approval: Yes

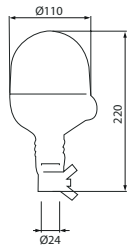
**171424 Rotating Beacon**

Bulb incl.: Yes  
Voltage: 24

OD: 110 mm  
Height: 220 mm  
Width: 110 mm

Bulb type: H1  
Lens type: Polycarbonate  
Colour: Orange  
Model: Microboule  
Mount.: Rod (ISO-DIN A)  
Base: Flexible  
Hi impact: Yes  
Tightness norm: IP 55  
Approvals: CE  
E-approval: Yes

**171587 Rotating Beacon**

Lens: HC-CARGO 170945.

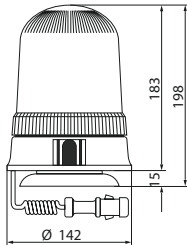

Bulb incl.: No  
Voltage: 12/24

OD: 142 mm  
Height: 198 mm  
Width: 142 mm

Bulb type: H1  
Colour: Orange  
Model: Astral  
Mount.: 1 magnet  
Coiled cable incl.: Yes  
E-approval: Yes

**171588 Rotating Beacon**

Lens: HC-CARGO 170945.

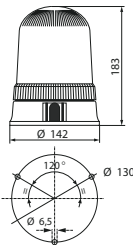

Bulb incl.: No  
Voltage: 12/24

OD: 142 mm  
Height: 183 mm  
Width: 142 mm

Bulb type: H1  
Colour: Orange  
Model: Astral  
Mount.: Single bolt  
E-approval: Yes

**171705 Rotating Beacon**

Lens: HC-CARGO 170308. Motor: HC-CARGO 170505, 170506.

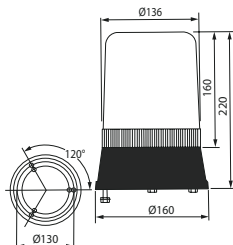

Bulb incl.: No  
Voltage: 12/24

OD: 160 mm  
Height: 220 mm

Bulb type: H1  
Lens type: PMMA/ACRYL  
Colour: Orange  
Model: AEB TYPE 595  
Mount.: Plan (ISO-DIN B)  
E-approval: Yes

**171793 Rotating Beacon**

Lens: HC-CARGO 170945.

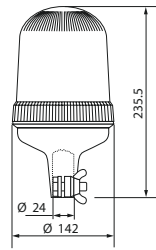

Bulb incl.: No  
Voltage: 12/24

OD: 142 mm  
Height: 235.5 mm

Bulb type: H1  
Lens type: Polycarbonate  
Colour: Orange  
Model: Astral flex  
Mount.: Standard ISO A - Rod  
Base: Flexible  
Hi impact: Yes  
E-approval: Yes

**SPARE PARTS**

**170308 Dome**

Servicing: HC-CARGO 170295, 170296, 170435, 170436, 170437, 170438, 170798, 171399

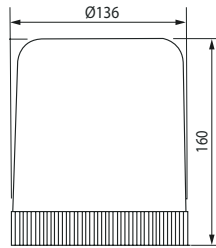

Height: 160 mm  
Width: 136 mm

Lens type: PMMA/ACRYL  
Colour: Orange  
Model: TYPE 590/595/595M

**170309 Base Plate**

Servicing: HC-CARGO 170295, 170296, 170435, 170436, 170437, 170438, 170798, 171399

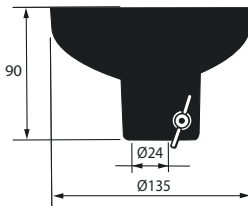

Height: 90 mm  
Width: 135 mm

Model: TYPE 590/595/595M

**170366 Dome**

Servicing: HC-CARGO 170295, 170296, 170435, 170436, 170437, 170438, 170798, 171399

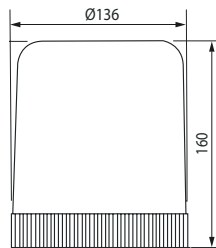

Height: 160 mm  
Width: 136 mm

Lens type: PMMA/ACRYL  
Colour: Blue  
Model: TYPE 590/595/595M

**170505 Beacon Motor**

Servicing: HC-CARGO 170295, 170296, 170435, 170436, 170437, 170438, 170798, 171399



Voltage: 12

Height: 65 mm  
Width: 30 mm

Model: TYPE 590/595/595M

**170506 Beacon Motor**

Servicing: HC-CARGO 170295, 170296, 170435, 170436, 170437, 170438, 170798, 171399









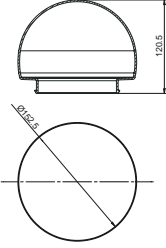

Voltage: 24

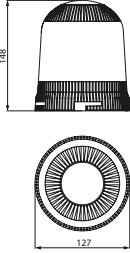
Height: 65 mm  
Width: 30 mm

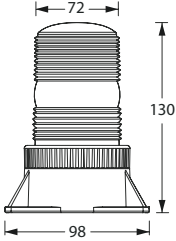
Model: TYPE 590/595/595M

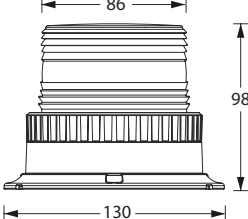

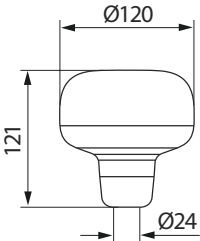
170543 Dome		Servicing: HC-CARGO 170540, 170541		
			Height: 120.5 mm Width: 152.5 mm	Lens type: Polycarbonate Colour: Orange Model: Boule Hi impact: Yes
170945 Dome		Servicing: HC-CARGO 170830, 171019, 171577, 171587, 171588, 171793, 172027, 172028, 172029, 172030, 172030UK		
			Height: 148 mm Width: 127 mm	Lens type: PMMA/ACRYL Colour: Orange Model: Astral E-approval: Yes
172110 Dome		Servicing: HC-CARGO 172099, 172100, 172101		
			OD: 140 mm	Lens type: PMMA/ACRYL Colour: Orange E-approval: Yes
ROTATING BEACONS LED				
171673 LED Beacon		Voltage: 11-110 Amp: 0.7 Watt: 6		
			OD: 98 mm Length: 98 mm Cable length: 300 mm Height: 130 mm Width: 72 mm	Bulb type: 6 LED Lens type: Polycarbonate Flash rate: 45 min. Colour: Orange Mount.: Plan Hi impact: Yes Coiled cable incl.: No Waterproof: Yes Tightness norm: IP 66 Approvals: SAE/CE E-approval: No
171674 LED Beacon		Voltage: 11-110 Amp: 0.7 Watt: 6		
			OD: 130 mm Length: 130 mm Cable length: 300 mm Height: 98 mm Width: 86 mm	Bulb type: 6 LED Lens type: Polycarbonate Flash rate: 45 min. Colour: Orange Mount.: Plan Hi impact: Yes Coiled cable incl.: No Waterproof: Yes Tightness norm: IP 66 Approvals: SAE/CE E-approval: No
171763 LED Beacon		Voltage: 12/24 Amp: 1.7/0.8		
			OD: 120 mm Height: 121 mm Width: 120 mm	Bulb type: LED Lens type: Polycarbonate Flash rate: 130 min. Colour: Orange Material: Aluminium Mount.: Standard ISO A - Rod Base: Rigid Flash patterns: 2 Hi impact: Yes Waterproof: Yes Tightness norm: IP 66 Approvals: ECE-R65 E-approval: Yes

**171764** LED Beacon

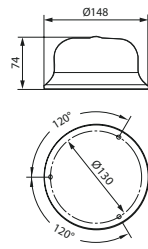

Voltage: 12/24  
Amp: 1.7/0.8

OD: 148 mm  
Height: 74 mm  
Dist. mount. holes:  
130 mm  
Width: 148 mm

Bulb type: LED  
Lens type: Polycarbonate  
Flash rate: 130 min.  
Colour: Orange  
Material: Aluminium  
Mount.: Plan  
Flash patterns: 2  
Hi impact: Yes  
Waterproof: Yes  
Tightness norm: IP 66  
Approvals: ECE-R65  
E-approval: Yes

**171918** LED Beacon

Lens: HC-CARGO 171941.

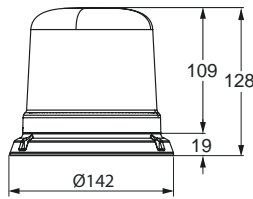

Voltage: 12-24  
Amp: 1.2/2.9  
Watt: 37

OD: 142 mm  
Cable length: 400 mm  
Height: 128 mm  
Width: 130 mm

Bulb type: 10 LED  
Lens type: Polycarbonate  
Colour: Orange  
Material: Aluminium  
Mount.: Plan  
Flash patterns: 11  
Hi impact: Yes  
Coiled cable incl.: No  
Waterproof: Yes  
Tightness norm: IP 65  
Approvals: SAE/ECE-R65  
E-approval: Yes

**171919** LED Beacon

Lens: HC-CARGO 171941.

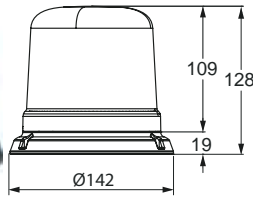

Voltage: 12-24  
Amp: 1.2/2.9  
Watt: 37

OD: 142 mm  
Cable length: 3000 mm  
Height: 128 mm  
Width: 130 mm

Bulb type: 10 LED  
Lens type: Polycarbonate  
Colour: Orange  
Material: Aluminium  
Mount.: Lighter Socket  
Base: Magnetic  
Flash patterns: 11  
Hi impact: Yes  
Waterproof: Yes  
Tightness norm: IP 65  
Approvals: SAE/ECE-R65  
E-approval: Yes

**171920** LED Beacon

Lens: HC-CARGO 171941.

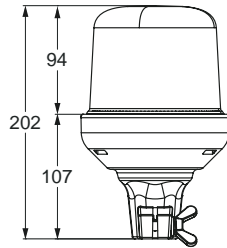

Voltage: 12-24  
Amp: 1.2/2.9  
Watt: 37

OD: 130 mm  
Height: 202 mm  
Width: 130 mm

Bulb type: 10 LED  
Lens type: Polycarbonate  
Colour: Orange  
Material: Aluminium  
Mount.: Standard ISO A - Rod  
Flash patterns: 11  
Hi impact: Yes  
Waterproof: Yes  
Tightness norm: IP 65  
Approvals: SAE/ECE-R65  
E-approval: Yes

**171921** LED Beacon

Lens: HC-CARGO 171942.

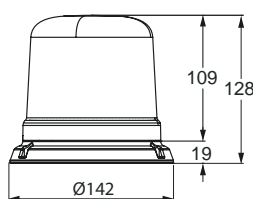

Voltage: 12-24  
Amp: 1.2/2.9  
Watt: 37

OD: 142 mm  
Height: 128 mm  
Width: 130 mm

Bulb type: LED  
Lens type: Polycarbonate  
Colour: Blue  
Material: Aluminium  
Model: LED  
Mount.: Plan  
Flash patterns: 11  
Hi impact: Yes  
Coiled cable incl.: No  
Waterproof: Yes  
Tightness norm: IP 65  
Approvals: SAE/ECE-R65  
E-approval: Yes

**171922 LED Beacon**

Lens: HC-CARGO 171942.

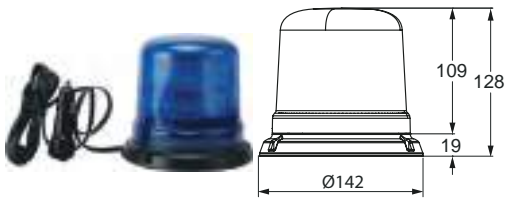

Voltage: 12-24  
Amp: 1.2/2.9  
Watt: 37

OD: 142 mm  
Height: 128 mm  
Width: 130 mm

Bulb type: LED  
Lens type: Polycarbonate  
Colour: Blue  
Material: Aluminium  
Model: LED  
Mount.: 3 magnets  
Flash patterns: 11  
Hi impact: Yes  
Coiled cable incl.: Yes  
Waterproof: Yes  
Tightness norm: IP 65  
Approvals: SAE/ECE-R65  
E-approval: Yes

**171923 LED Beacon**

Lens: HC-CARGO 171942.

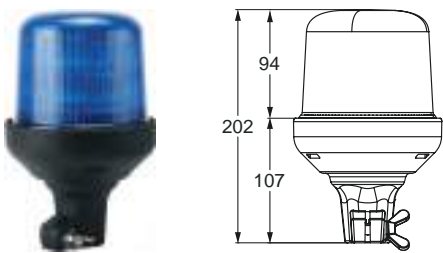

Voltage: 12-24  
Amp: 1.2/2.9  
Watt: 37

OD: 130 mm  
Height: 202 mm  
Width: 130 mm

Bulb type: LED  
Lens type: Polycarbonate  
Colour: Blue  
Material: Aluminium  
Model: LED  
Mount.: Standard ISO A - Rod  
Flash patterns: 11  
Hi impact: Yes  
Waterproof: Yes  
Tightness norm: IP 65  
Approvals: SAE/ECE-R65  
E-approval: Yes

**171931 LED Beacon**



Voltage: 12-36  
Amp: 2.9/1.8  
Watt: 35/44

OD: 161.9 mm  
Cable length: 340 mm  
Height: 88.5 mm  
Width: 161.9 mm

Bulb type: 12 LED  
Colour: Orange  
Model: 12 LED  
Mount.: Plan  
Waterproof: Yes  
Tightness norm: IP 67  
Approvals: EMC-R10/ECE-R65  
E-approval: Yes

**171957 LED Beacon**

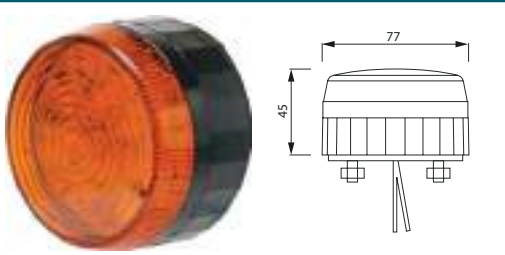

Voltage: 10-100  
Amp: 0.1  
Watt: 1.2

OD: 77 mm  
Cable length: 410 mm  
Height: 45 mm  
Dist. mount. holes: 45 mm  
Width: 77 mm

Bulb type: 12 LED  
Lens type: Polycarbonate  
Colour: Orange  
Material: Polycarbonate  
Mount.: Plan  
Flash patterns: 4  
Hi impact: Yes  
Tightness norm: IP 67  
Approvals: CE/EMC  
E-approval: No

**171971 LED Beacon**



Voltage: 12-24  
Amp: 2  
Watt: 15

OD: 143 mm  
Cable length: 150 mm  
Height: 86.4 mm  
Width: 143 mm

Bulb type: 8 LED  
Colour: Orange  
Material: Polycarbonate  
Model: LED  
Mount.: Plan  
Flash patterns: 1  
Tightness norm: IP 66  
Approvals: CE/EMC/ECE-R65  
E-approval: Yes

**171972 LED Beacon**

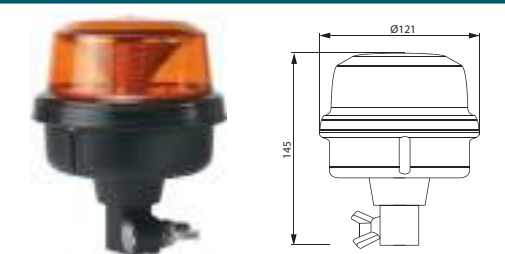

Voltage: 12-24  
Amp: 2  
Watt: 15

OD: 121 mm  
Height: 143 mm

Bulb type: 6 LED  
Colour: Orange  
Material: Polycarbonate  
Model: LED  
Mount.: Standard ISO A - Rod  
Flash patterns: 1  
Hi impact: Yes  
Tightness norm: IP 66  
Approvals: CE/EMC/ECE-R65  
E-approval: Yes

**171973 LED Beacon**

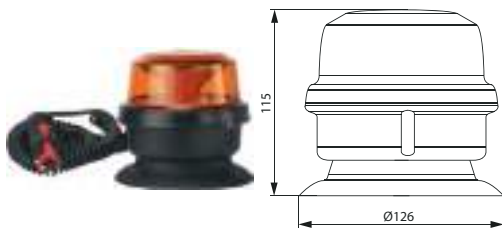

Voltage: 12-24  
Amp: 2  
Watt: 15

OD: 126 mm  
Cable length: 2000 mm  
Height: 115 mm  
Width: 126 mm

Bulb type: 8 LED  
Colour: Orange  
Material: Polycarbonate  
Model: LED  
Mount.: Lighter Socket  
Base: Magnetic/vacuum  
Flash patterns: 1  
Hi impact: Yes  
Coiled cable incl.: Yes  
Tightness norm: IP 66  
Approvals: CE/EMC/ECE-R65  
E-approval: Yes

**172027 LED Beacon**

Lens: HC-CARGO 170945.

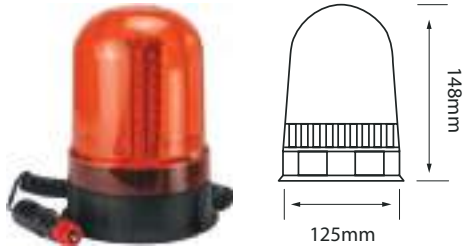

Voltage: 10-30  
Amp: 1.5  
Watt: 18

Cable length: 180 mm  
Height: 148 mm  
Dist. mount. holes: 107 mm  
Width: 125 mm

Bulb type: 80 LED  
Lens type: Polycarbonate  
Colour: Orange  
Material: Plastic/nylon/rubber  
Mount.: Lighter Socket  
Base: Magnetic/vacuum  
Flash patterns: 3  
Coiled cable incl.: Yes  
Tightness norm: IP 65  
Approvals: ECE-R65  
E-approval: Yes

**172028 LED Beacon**

Lens: HC-CARGO 170945.

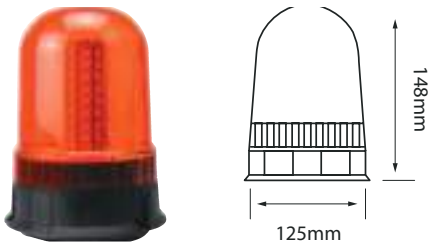

Voltage: 10-30  
Amp: 1.5  
Watt: 18

Cable length: 95 mm  
Height: 148 mm  
Dist. mount. holes: 107 mm  
Width: 125 mm

Bulb type: 80 LED  
Lens type: Polycarbonate  
Colour: Orange  
Material: Plastic/nylon/rubber  
Mount.: Plan  
Base: Vacuum  
Flash patterns: 3  
Tightness norm: IP 65  
Approvals: ECE-R65  
E-approval: Yes

**172029 LED Beacon**

Lens: HC-CARGO 170945.

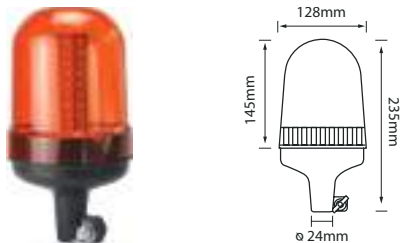

Voltage: 10-30  
Amp: 1.5  
Watt: 18

Height: 235 mm  
Width: 128 mm

Bulb type: 80 LED  
Lens type: Polycarbonate  
Colour: Orange  
Material: Plastic/nylon/rubber  
Mount.: Standard ISO A - Rod  
Base: Rigid  
Flash patterns: 3  
Tightness norm: IP 65  
Approvals: ECE-R65  
E-approval: Yes

**172030 LED Beacon**

Lens: HC-CARGO 170945. w/ battery.

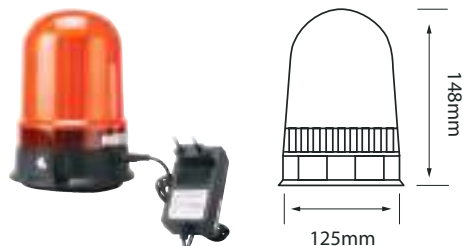

Voltage: 12  
Amp: 1.5  
Watt: 18

Height: 148 mm  
Dist. mount. holes: 107 mm  
Width: 125 mm

Bulb type: LED  
Lens type: Polycarbonate  
Colour: Orange  
Material: Plastic/nylon/rubber  
Model: 80 LEDs  
Mount.: Plan  
Base: Magnetic/vacuum  
Flash patterns: 3  
Tightness norm: IP 65  
Approvals: ECE-R65  
E-approval: Yes

**172030UK# LED Beacon**

Servicing: UK

Lens: HC-CARGO 170945. w/ battery.

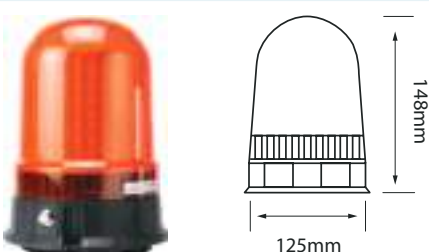

Voltage: 10-30

Height: 148 mm  
Width: 125 mm

Bulb type: LED  
Lens type: Polycarbonate  
Colour: Orange  
Material: Plastic/nylon/rubber  
Model: 80 LEDs  
Mount.: Plan  
Base: Magnetic/vacuum  
Flash patterns: 3  
Tightness norm: IP 65  
Approvals: ECE-R65  
E-approval: Yes

**172075 LED Beacon UK Version**

Servicing: UK

Lens: HC-CARGO 170945. w/ battery.

**NEW PRODUCT**  
www.hc-cargo.com

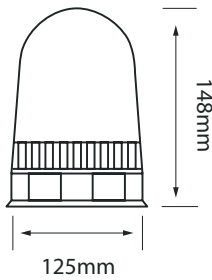

Voltage: 10-30  
Amp: 1.5  
Watt: 18

Height: 148 mm  
Dist. mount. holes:  
107 mm  
Width: 125 mm

Bulb type: LED  
Lens type: Polycarbonate  
Colour: Orange  
Material: Plastic/nylon/rubber  
Model: 80 LEDs  
Mount.: Plan  
Base: Magnetic/vacuum  
Flash patterns: 3  
Tightness norm: IP 65  
Approvals: ECE-R65  
E-approval: Yes

**172099 LED Beacon**

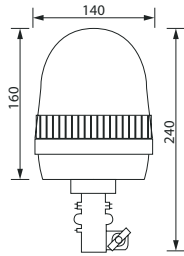

Voltage: 10-30  
Watt: 9

Height: 230 mm  
Width: 140 mm

Bulb type: 40 LED  
Lens type: Polycarbonate  
Colour: Orange  
Material: Plastic/nylon/rubber  
Mount.: Standard ISO A - Rod  
Base: Flexible  
Flash patterns: 3  
Tightness norm: IP 65  
Approvals: ECE-R65  
E-approval: Yes

**172100 LED Beacon**

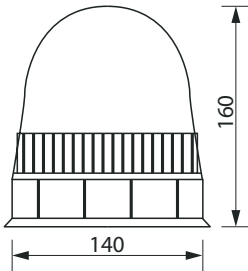

Voltage: 10-30  
Watt: 9

Height: 140 mm  
Dist. mount. holes:  
107 mm  
Width: 140 mm

Bulb type: 40 LED  
Lens type: Polycarbonate  
Colour: Orange  
Material: Plastic/nylon/rubber  
Mount.: Plan  
Flash patterns: 3  
Tightness norm: IP 65  
Approvals: ECE-R65  
E-approval: Yes

**172101 LED Beacon**

Max. 120 kph.

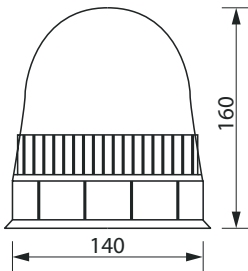

Voltage: 10-30  
Watt: 9

Height: 140 mm  
Dist. mount. holes:  
107 mm  
Width: 140 mm

Bulb type: 40 LED  
Lens type: Polycarbonate  
Colour: Orange  
Material: Plastic/nylon/rubber  
Mount.: Plan  
Base: Magnetic/vacuum  
Flash patterns: 3  
Coiled cable incl.: Yes  
Tightness norm: IP 65  
Approvals: ECE-R65  
E-approval: Yes

**SPARE PARTS**

**171941 Lens**

Servicing: HC-CARGO 171918, 171919, 171920



Lens type: Polycarbonate  
Colour: Orange

**171942 Lens**

Servicing: HC-CARGO 171921, 171922, 171923



Lens type: Polycarbonate  
Colour: Blue

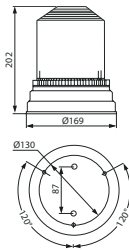

**ROTATING BEACONS XENON**
**170651 Xenon Beacon**

Bulb incl.: Yes  
Voltage: 24  
Amp: 1.5

OD: 169 mm  
Height: 202 mm

Bulb type: LX10J  
Lens type: PMMA/ACRYL  
Colour: Orange  
Model: XENON FT6 AG ELECTRONIC  
Mount.: Standard ISO B2 (and B1) - Base  
Tightness norm: IP 55  
E-approval: Yes

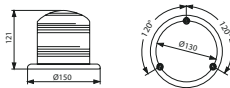
**170680 Xenon Beacon**

Bulb incl.: Yes  
Voltage: 10-100  
Amp: 200/50  
mAmpere

OD: 150 mm  
Height: 121 mm  
Width: 150 mm

Bulb type: LX1J  
Lens type: Polycarbonate  
Colour: Orange  
Material: Polycarbonate  
Model: FLASH ELEV  
Mount.: Standard ISO B2 (and B1) - Base  
Base: Rigid  
Hi impact: Yes  
Tightness norm: IP 54  
Approvals: CE/EMC

**171005 Xenon Beacon**

w/ Xenon tube. Lens: HC-CARGO 171590.

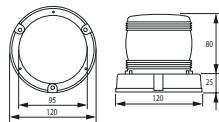

Bulb incl.: Yes  
Voltage: 10-100

OD: 120 mm  
Height: 105 mm

Bulb type: LX10J  
Lens type: PMMA/ACRYL  
Colour: Orange  
Model: TYPE TRASPOT XENON  
Mount.: Standard ISO B2 (and B1) - Base  
Approvals: CE/EMC

**171498 Xenon Beacon**

w/ built-in audible signal.

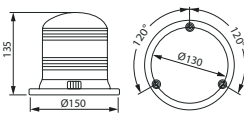

Bulb incl.: Yes  
Voltage: 10-100  
Amp: 200/50  
mAmpere

OD: 150 mm  
Height: 135 mm  
Width: 150 mm

Bulb type: LX1J  
Lens type: Polycarbonate  
Colour: Orange  
Model: FLASH ELEV SL  
Mount.: Standard ISO B2 (and B1) - Base  
Hi impact: Yes  
Tightness norm: IP 20

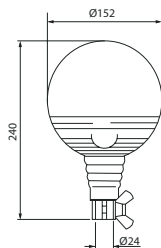
**171541 Xenon Beacon**

Bulb incl.: Yes  
Voltage: 24  
Amp: 1.5

OD: 152 mm  
Height: 240 mm

Bulb type: LX8J  
Lens type: Polycarbonate  
Colour: Orange  
Model: BOULE FLASH  
Mount.: Standard ISO A - Rod  
Base: Flexible  
Hi impact: Yes  
Tightness norm: IP 66  
E-approval: Yes

**171561 Xenon Beacon**

w/ Xenon tube. Lens: HC-CARGO 171590.

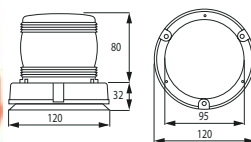

Bulb incl.: Yes  
Voltage: 10-100

OD: 120 mm  
Height: 112 mm  
Width: 120 mm

Lens type: PMMA/ACRYL  
Colour: Orange  
Model: Type TRASPOT  
Mount.: Standard ISO B2 (and B1) - Base  
Base: Magnetic  
Coiled cable incl.: Yes  
Approvals: CE/EMC

**171614 Xenon Beacon**

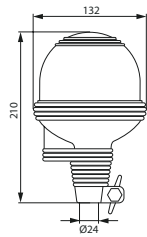

Bulb incl.: Yes  
Voltage: 10-30

OD: 132 mm  
Height: 210 mm

Bulb type: LX10J  
Lens type: Polycarbonate  
Colour: Orange  
Model: Xenon  
Mount.: Standard ISO A - Rod  
Hi impact: Yes  
E-approval: Yes

**171708 Xenon Beacon**

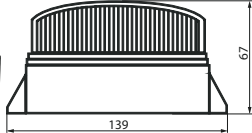

Bulb incl.: Yes  
Voltage: 11-120  
Amp: 0.2

Length: 139 mm  
Height: 67 mm  
Dist. mount. holes: 130 mm  
Width: 67 mm

Bulb type: Xenon  
Lens type: Polycarbonate  
Flash rate: 72 min.  
Colour: Orange  
Mount.: Plan  
Hi impact: Yes  
Waterproof: Yes  
Approvals: CE

**171798 Xenon Beacon**

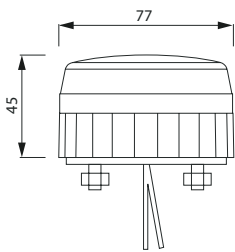

Voltage: 10-100  
Watt: 5

OD: 77 mm  
Height: 45 mm  
Dist. mount. holes: 45 mm

Bulb type: Xenon  
Lens type: Polycarbonate  
Flash rate: 75 min.  
Colour: Orange  
Material: Polycarbonate  
Mount.: Plan  
Hi impact: Yes  
Tightness norm: IP 67  
Approvals: CE

**SPARE PARTS**

**170654 Xenon Bulb**

Servicing: HC-CARGO 170650, 170651, 171505, 171005



Bulb incl.: Yes  
Voltage: 12/24  
Watt: 16

Bulb type: LX10J  
Model: XENON FT6 /FLX ELECTRONIC

**171590 Dome**

Servicing: HC-CARGO 171005, 171561



Lens type: PMMA/ACRYL  
Colour: Orange  
Model: TRASPORT XENON

**WORK LAMPS CONVENTIONAL**

**170851 Work Lamp**

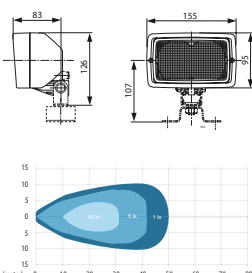

Bulb incl.: No

Dim.: 155x95x83 mm  
Light aperture: 136x88 mm

Type: H3  
Socket type: PK22s  
Colour: Black  
Material/dome: Glass  
Material/house: Shockproof plastic  
Reflector system: Dual  
Shape: Rectangular  
Switch: w/o  
Mount. bracket: U-bracket w/ 6 holes  
Handle: w/o  
Tightness norm: IP 54

**171620 Work Lamp**

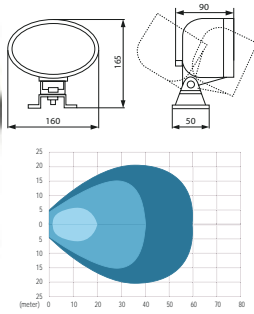

Bulb incl.: No

Dim.: 160x165x90 mm  
Light aperture:  
77x130 mm

Type: H3  
Socket type: PK22s  
Colour: Black  
Material/dome: Shockproof plastic  
**Reflector system:** Dual  
Model: Twin beam 5000  
Shape: Oval  
Mount. bracket: 4 holes  
2 poles: w/

**171845 Work Lamp**

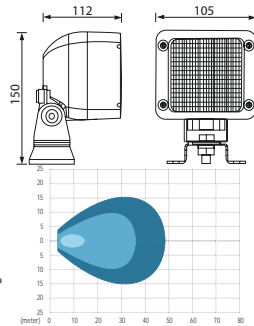

Servicing: Marine

Bulb incl.: No  
Voltage: 12  
Watt: 55

Dim.: 105x150x112 mm

Type: H3  
Socket type: PK22s  
Colour: White  
Material/dome: Glass  
Shape: Square  
Mount.: Single bolt fixing  
Mount. bracket: Mounting bracket  
Tightness norm: IP 65

**171848 Work Lamp**

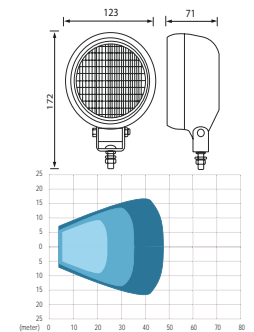

Bulb incl.: No

Dim.: 123x172x71 mm

Type: H3  
Socket type: PK22s  
Colour: Black  
Material/dome: Glass  
Material/house: PVC  
Shape: Round  
Mount. bracket: Single bolt fixing

**WORK LAMPS LED**

**171640 LED Work Lamp**

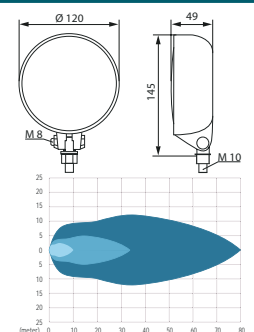

Voltage: 9-30  
Watt: 24  
Lumen: 1440

Dim.: 120x145x49 mm  
Cable length: 150 mm  
Light aperture:  
130 mm

Type: 8 LED  
Colour: Grey  
Material/house: Aluminium  
Shape: Round  
Switch: w/o  
Mount. bracket: 1 nut  
Magnet base: w/o  
Handle: w/o  
2 poles: w/  
Tightness norm: IP 69K  
Approvals: EMC/ADR/GGVS

**171671 LED Work Lamp**

4 diodes. Black cable negative.

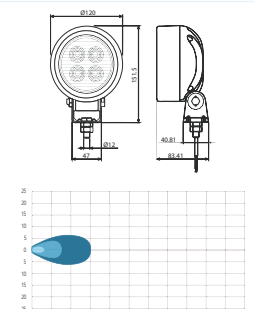

Voltage: 10-64  
Watt: 8.5  
Candela: 800  
Kelvin: 5000-6500  
Lumen: 450

Dim.:  
151.5x120x83.41 mm  
Cable length: 2000 mm  
Light aperture:  
100 mm

Type: 4 LED  
Colour: Black  
Material/dome: Shockproof plastic  
Material/house: Shock thermo plastic  
Shape: Round  
Switch: w/o  
Mount. bracket: 1 nut  
Magnet base: w/o  
Handle: w/o  
Tightness norm: IP 66  
Approvals: CE

**171672 LED Work Lamp**

4 diodes.

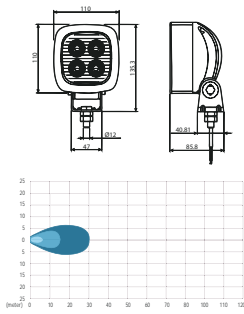

Voltage: 10-64  
Watt: 8.5  
Candela: 800  
Kelvin: 5000-6500  
Lumen: 450

Dim.: 135.5x110x85.8 mm  
Cable length: 2000 mm  
Light aperture: 100 mm

Type: 4 LED  
Colour: Black  
Material/dome: Shockproof plastic  
Material/house: Shockproof plastic  
Shape: Square  
Mount. bracket: 1 nut  
Tightness norm: IP 66  
Approvals: CE

**171723 LED Work Lamp**

Servicing: Marine

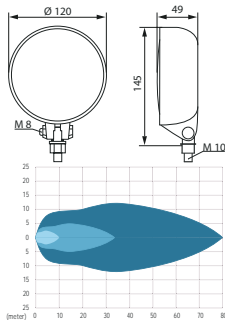

Voltage: 9-30  
Watt: 24  
Lumen: 1440

Dim.: 120x145x49 mm  
Cable length: 150 mm  
Light aperture: 130 mm

Type: 8 LED  
Colour: White  
Material/house: Aluminium  
Shape: Round  
Mount. bracket: 1 nut  
2 poles: w/  
Tightness norm: IP 69K  
Approvals: EMC/ADR/GGVS

**171727 LED Work Lamp**

Grey lead +, white lead -.

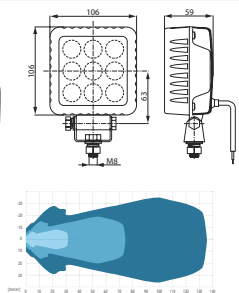

Voltage: 9-33  
Watt: 9  
Kelvin: 5000-5500  
Lumen: 900

Dim.: 106x106x59 mm  
Cable length: 450 mm  
Light aperture: 85x85 mm

Type: 9 LED  
Colour: Black  
Material/dome: Shockproof plastic  
Material/house: Cast aluminum  
Shape: Square  
Switch: w/o  
Mount. bracket: U-bracket w/ 1 bolt  
Handle: w/o  
Tightness norm: IP 67  
Approvals: CE/EMC

**171751 LED Work Lamp**

White cable to ground. Black cable to +12/36 V.

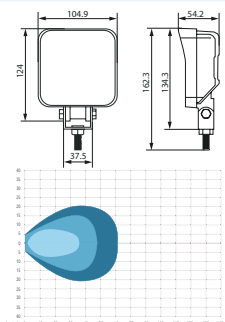

Voltage: 9-36  
Watt: 19  
Candela: 2210  
Lumen: 1200

Dim.: 104.9x162.3x54.2 mm  
Cable length: 280 mm  
Light aperture: 100x100 mm

Type: 6 LED  
Colour: Black  
Material/dome: Polycarbonate  
Material/house: Cast aluminum  
Shape: Square  
Switch: w/o  
Mount. bracket: U-bracket w/ 1 bolt  
Handle: w/o  
Tightness norm: IP 69K  
Approvals: CE/EMC

**171752 LED Work Lamp**

White cable to ground. Black cable to +12/36 V.

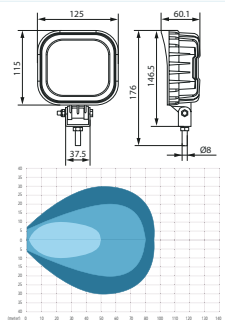

Voltage: 12-36  
Watt: 20  
Candela: 3600  
Lumen: 1800

Dim.: 125x176x60.1 mm  
Cable length: 280 mm  
Light aperture: 93x83 mm

Type: 9 LED  
Colour: Black  
Material/dome: Polycarbonate  
Material/house: Cast aluminum  
Shape: Square  
Switch: w/o  
Mount. bracket: U-bracket w/ 1 bolt  
Tightness norm: IP 69K  
Approvals: CE/EMC

**171753 LED Work Lamp**

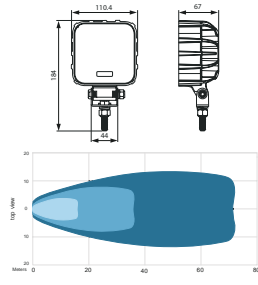

Voltage: 11-70  
Watt: 22  
Lumen: 1000

Dim.: 110.4x184x67 mm  
Cable length: 1200 mm  
Light aperture: 88x88 mm

Type: 6 LED  
Colour: Black  
Material/house: Cast aluminum  
Shape: Square  
Mount. bracket: Single bolt fixing  
Tightness norm: IP 67  
Approvals: EMC

**171755 LED Work Lamp**

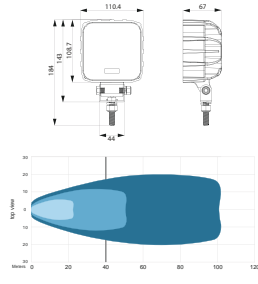

Voltage: 11-70  
Watt: 27  
Lumen: 1900

Dim.: 110.4x184x67 mm  
Cable length: 1200 mm  
Light aperture: 88x88 mm

Type: 6 LED  
Colour: Black  
Material/house: Cast aluminum  
Shape: Square  
Mount. bracket: Single bolt fixing  
Tightness norm: IP 67  
Approvals: EMC  
E-approval: No

**171774 LED Work Lamp**

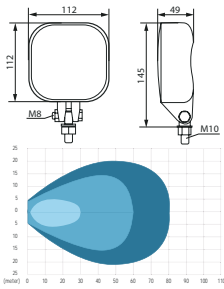

Voltage: 11-30  
Watt: 40  
Lumen: 3200

Dim.: 112x112x49 mm  
Cable length: 150 mm

Type: 12 LED  
Colour: Silver  
Material/house: Cast aluminum  
Shape: Square  
Mount. bracket: U-bracket w/ 1 bolt  
2 poles: w/  
Tightness norm: IP 69K  
Approvals: EMC/ADR/GGVS

**171775 LED Work Lamp**

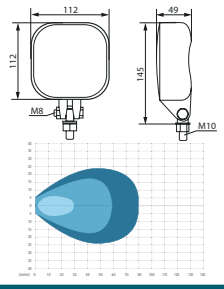

Voltage: 11-30  
Watt: 36  
Lumen: 1800

Dim.: 112x112x49 mm  
Cable length: 150 mm

Type: 12 LED  
Colour: Silver  
Material/house: Cast aluminum  
Shape: Square  
Mount. bracket: U-bracket w/ 1 bolt  
2 poles: w/  
Tightness norm: IP 69K  
Approvals: EMC/ADR/GGVS

**171811 LED Work Lamp**

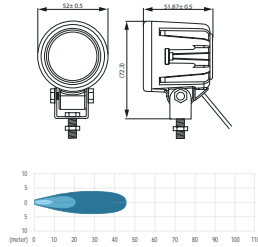

Voltage: 10-80  
Watt: 5  
Candela: 2000  
Kelvin: 5000-6500  
Lumen: 600

Dim.: 72.3x52x51.87 mm  
Cable length: 300 mm  
Light aperture: 35 mm

Type: 1 LED  
Inclination/downwards: Yes  
Inclination/upwards: Yes  
Colour: Black  
Material/dome: Plastic  
Material/house: Aluminium  
Shape: Round  
Mount. bracket: U-bracket w/ 1 bolt  
Tightness norm: IP 66  
Approvals: CE

**171838 LED Work Lamp**

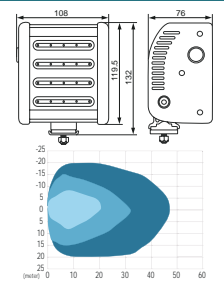

Voltage: 9-36  
Amp: 1.2/2.5  
Watt: 28-30  
Lumen: 3000

Dim.: 132x108x76 mm  
Cable length: 150 mm

Type: 20 LED  
Colour: Black  
Material/dome: Polycarbonate  
Material/house: Aluminium  
Shape: Square  
Mount. bracket: Single bolt fixing  
2 poles: w/  
Tightness norm: IP 67  
Approvals: CE/EMC



**171846 LED Work Lamp**

2 pin AMP connector.

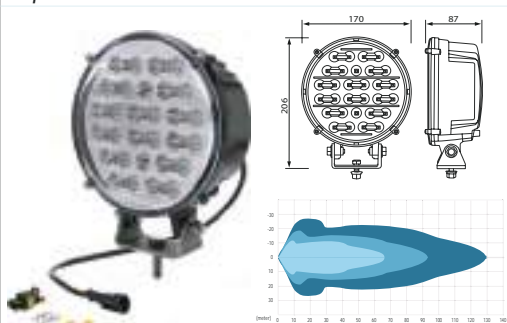

Voltage: 9-36  
Amp: 6/3  
Watt: 67.5  
Lumen: 5400

Dim.: 170x206x87 mm  
Cable length: 450 mm

Type: 30 LED  
Inclination/downwards: 45°  
Inclination/upwards: 45°  
Colour: Black  
Material/dome: Polycarbonate  
Material/house: Aluminium  
Shape: Round  
Mount. bracket: U-bracket w/ 1 bolt  
2 poles: w/  
Tightness norm: IP 67  
Approvals: SAE/CE

**171847 LED Work Lamp**

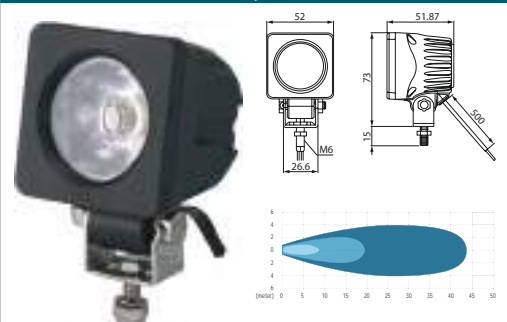

Voltage: 10-80  
Amp: 0.3  
Watt: 5  
Candela: 2000  
Kelvin: 5000-6500  
Lumen: 600

Dim.: 52x51.9x72.3 mm  
Cable length: 500 mm

Type: 1 LED  
Inclination/downwards: Yes  
Inclination/upwards: Yes  
Colour: Black  
Shape: Square  
Tightness norm: IP 67  
Approvals: CE

**171938 LED Work Lamp**

Flood type.

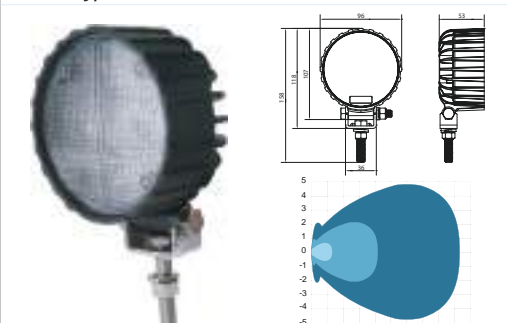

Voltage: 9-50  
Amp: <0.55  
Watt: 10.8  
Lumen: 900

Dim.: 96x118x53 mm  
Cable length: 380 mm  
Light aperture: 90 mm

Type: 4 LED  
Colour: Black  
Material/dome: Polycarbonate  
Material/house: Aluminium  
Shape: Round  
Mount. bracket: 1 bolt  
Tightness norm: IP 68  
Approvals: CE/EMC

**171939 LED Work Lamp**

Spot.

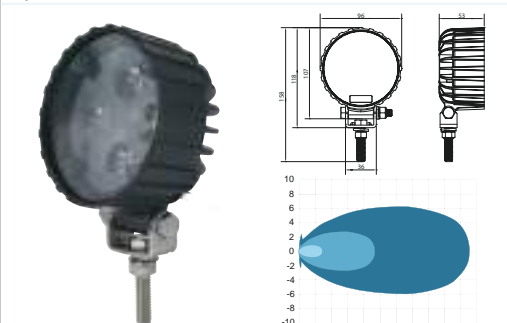

Voltage: 9-50  
Amp: <0.65  
Watt: 11  
Lumen: 900

Dim.: 96x118 mm  
Cable length: 380 mm  
Light aperture: 90 mm

Type: 4 LED  
Colour: Black  
Material/dome: Polycarbonate  
Material/house: Aluminium  
Shape: Round  
Mount. bracket: 1 bolt  
Tightness norm: IP 68  
Approvals: CE/EMC

**171940 LED Work Lamp**

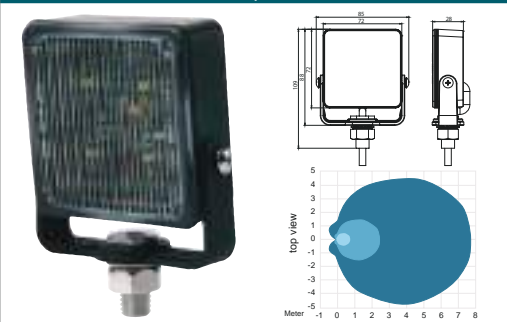

Voltage: 12-24  
Amp: 0.37  
Watt: 7.5  
Lumen: 300

Dim.: 88x85 mm  
Cable length: 380 mm  
Light aperture: 72 mm

Type: 4 LED  
Material/dome: Polycarbonate  
Material/house: Aluminium  
Shape: Square  
Mount. bracket: U-bracket w/ 1 bolt  
Tightness norm: IP 67  
Approvals: CE

**171944 LED Work Lamp**

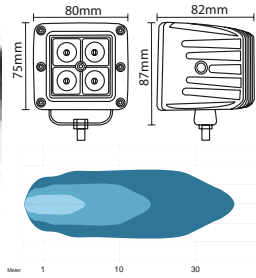

Voltage: 10-30  
Watt: 16  
Kelvin: 6000  
Lumen: 800

Dim.: 87x80x75 mm  
Cable length: 400 mm

Type: 4 LED  
Colour: Black  
Material/ bracket: Stainless steel  
Material/dome: Polycarbonate  
Material/house: Cast aluminum  
Shape: Square  
Mount.: Cable  
Tightness norm: IP 67  
Approvals: CE/EMC

**171945 LED Work Lamp**

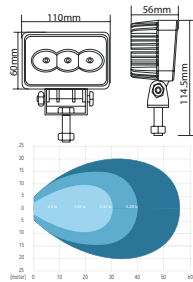

Voltage: 10-30  
Watt: 9  
Kelvin: 6000  
Lumen: 600

Dim.: 60x110x56 mm  
Cable length: 400 mm

Type: 3 LED  
Colour: Black  
Material/ bracket: Stainless steel  
Material/dome: Polycarbonate  
Material/house: Cast aluminum  
Shape: Rectangular  
Mount.: Cable  
Tightness norm: IP 67  
Approvals: CE/EMC

**171946 LED Work Lamp**

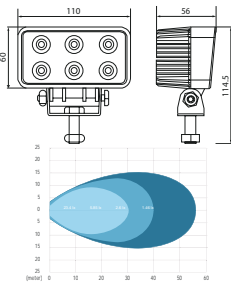

Voltage: 10-30  
Watt: 18  
Kelvin: 6000  
Lumen: 1200

Dim.: 60x110x56 mm  
Cable length: 400 mm

Type: 6 LED  
Colour: Black  
Material/ bracket: Stainless steel  
Material/dome: Polycarbonate  
Material/house: Cast aluminum  
Shape: Rectangular  
Mount.: Cable  
Tightness norm: IP 67  
Approvals: CE

**171947 LED Work Lamp**

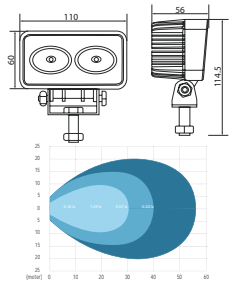

Voltage: 10-30  
Watt: 20  
Kelvin: 6000  
Lumen: 1600

Dim.: 60x110x56 mm  
Cable length: 400 mm

Type: 2 LED  
Colour: Black  
Material/ bracket: Stainless steel  
Material/dome: Polycarbonate  
Material/house: Cast aluminum  
Shape: Rectangular  
Mount.: Cable  
Tightness norm: IP 67  
Approvals: CE/EMC

**171948 LED Work Lamp**

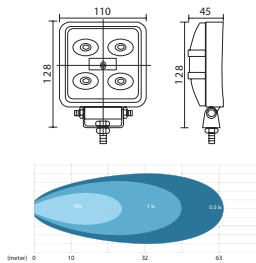

Voltage: 10-30  
Watt: 15  
Kelvin: 6000  
Lumen: 1100

Dim.: 128x110x45 mm  
Cable length: 400 mm

Type: 5 LED  
Colour: Black  
Material/ bracket: Stainless steel  
Material/dome: Polycarbonate  
Material/house: Cast aluminum  
Shape: Square  
Mount.: Cable  
Tightness norm: IP 67  
Approvals: CE/EMC

**171949 LED Work Lamp**

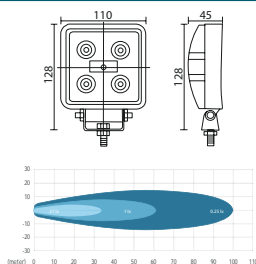

Voltage: 10-30  
Watt: 15  
Kelvin: 6000  
Lumen: 1100

Dim.: 128x110x45 mm  
Cable length: 400 mm

Type: 5 LED  
Colour: Black  
Material/ bracket: Stainless steel  
Material/dome: Polycarbonate  
Material/house: Cast aluminum  
Shape: Square  
Mount.: Cable  
Tightness norm: IP 67  
Approvals: CE/EMC

**171950 LED Work Lamp**

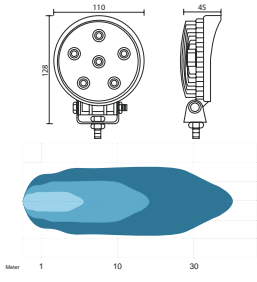

Voltage: 10-30  
Watt: 18  
Kelvin: 6000  
Lumen: 1200

Dim.: 128x110x45 mm  
Cable length: 400 mm

Type: 6 LED  
Colour: Black  
Material/ bracket: Stainless steel  
Material/dome: Polycarbonate  
Material/house: Cast aluminum  
Shape: Round  
Mount.: Cable  
Tightness norm: IP 67  
Approvals: CE/EMC

**171951 LED Work Lamp**

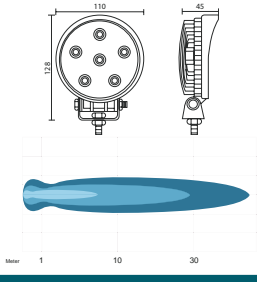

Voltage: 10-30  
Watt: 18  
Kelvin: 6000  
Lumen: 1200

Dim.: 128x110x45 mm  
Cable length: 400 mm

Type: 6 LED  
Colour: Black  
Material/ bracket: Stainless steel  
Material/dome: Polycarbonate  
Material/house: Cast aluminum  
Shape: Round  
Mount.: Cable  
Tightness norm: IP 67  
Approvals: CE/EMC

**171955 LED Work Lamp**

Accessories: HC-CARGO 190252, 190261, 191029, 193010.

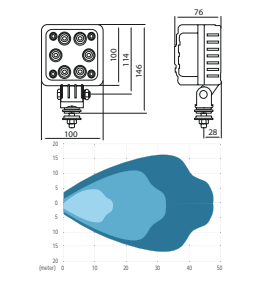

Voltage: 12-24  
Watt: 24  
Kelvin: 5000-7000  
Lumen: 1500

Dim.: 100x100x76 mm

Type: 6 LED  
Inclination/downwards: 80°  
Inclination/upwards: 90°  
Inclination/sideways: 180°  
Colour: Black  
Material/dome: Plastic  
Material/house: ABS plastic/aluminium  
Shape: Square  
2 poles: w/  
Tightness norm: IP 69K  
Approvals: CE/EMC

**172001 LED Work Lamp**

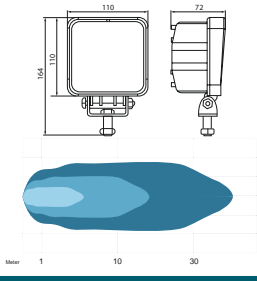

Voltage: 10-80  
Watt: 48  
Kelvin: 6000  
Lumen: 3500

Dim.: 164x110x72 mm

Type: 16 LED  
Colour: Black  
Material/ bracket: Stainless steel  
Material/dome: Polycarbonate  
Material/house: Cast aluminum  
Shape: Square  
Mount.: Cable  
2 poles: w/  
Tightness norm: IP 67  
Approvals: CE/EMC

**172003 LED Work Lamp**

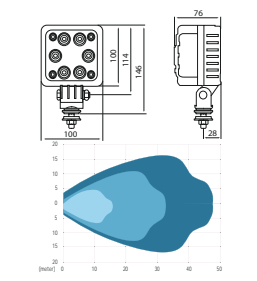

Voltage: 12-24  
Watt: 24  
Kelvin: 5000-7000  
Lumen: 1500

Dim.: 100x100x76 mm  
Cable length: 500 mm

Type: 6 LED  
Inclination/downwards: 80°  
Inclination/upwards: 90°  
Inclination/sideways: 180°  
Colour: Black  
Material/dome: Plastic  
Material/house: ABS plastic/aluminium  
Shape: Square  
Switch: w/  
Tightness norm: IP 69K  
Approvals: CE/EMC

**172004 LED Work Lamp**

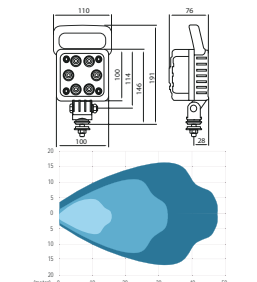

Voltage: 12-24  
Watt: 24  
Kelvin: 5000-7000  
Lumen: 1500

Dim.: 205x110x76 mm  
Cable length: 500 mm

Type: 6 LED  
Inclination/downwards: 80°  
Inclination/upwards: 90°  
Inclination/sideways: 180°  
Colour: Black  
Material/dome: Plastic  
Material/house: ABS plastic/aluminium  
Shape: Square  
Switch: w/  
Handle: w/  
Tightness norm: IP 69K  
Approvals: CE/EMC

**172010 LED Work Lamp**

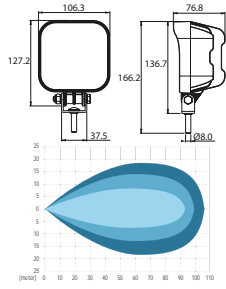

Voltage: 12-36  
Watt: 40  
Lumen: 3200

Dim.: 127.2x106.3x76.8 mm  
Cable length: 280 mm

Type: 4 LED  
Colour: Black  
Material/house: Aluminium  
Shape: Square  
Mount. bracket: U-bracket w/ 1 bolt  
Tightness norm: IP 69K  
Approvals: CE/EMC

**172017 LED Work Lamp**

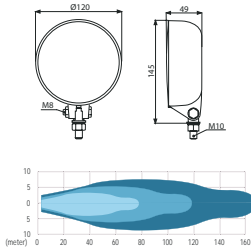

Voltage: 12-24  
Watt: 34  
Lumen: 2600

Dim.: 145x120x49 mm  
Cable length: 150 mm

Type: 12 LED  
Material/house: Aluminium  
Shape: Round  
Magnet base: w/  
2 poles: w/  
Tightness norm: IP 69K  
Approvals: EMC/ADR/GGVS

**172018 LED Work Lamp**

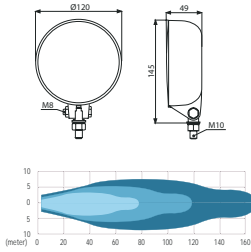

Voltage: 12-24  
Watt: 34  
Lumen: 2600

Dim.: 145x120x49 mm  
Cable length: 150 mm

Type: 12 LED  
Material/house: Aluminium  
Shape: Round  
2 poles: w/  
Tightness norm: IP 69K  
Approvals: EMC/ADR/GGVS

**172019 LED Work Lamp**

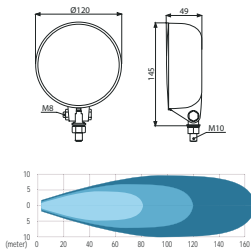

Voltage: 12-24  
Watt: 40  
Lumen: 4000

Dim.: 145x120x49 mm  
Cable length: 150 mm

Type: 12 LED  
Material/house: Aluminium  
Shape: Round  
2 poles: w/  
Tightness norm: IP 69K  
Approvals: EMC/ADR/GGVS

**172020 LED Work Lamp**

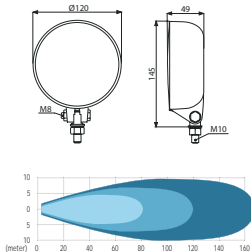

Voltage: 12-24  
Watt: 40  
Lumen: 4000

Dim.: 145x120x49 mm  
Cable length: 150 mm

Type: 12 LED  
Material/house: Aluminium  
Shape: Round  
Magnet base: w/  
2 poles: w/  
Tightness norm: IP 69K  
Approvals: EMC/ADR/GGVS

**172031 LED Work Lamp**

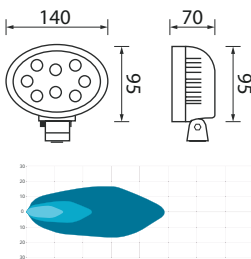

Voltage: 10-80  
Watt: 24  
Kelvin: 6000  
Lumen: 1920

Dim.: 140x95x70 mm  
Cable length: 400 mm

Type: 8 LED  
Material/dome: Acrylic  
Material/house: Cast aluminum  
Shape: Oval  
2 poles: w/  
Tightness norm: IP 69K  
Approvals: CE/EMC



**172032 LED Work Lamp**



Voltage: 10-80  
Watt: 36  
Kelvin: 6000  
Lumen: 2880

Dim.: 140x95x70 mm  
Cable length: 400 mm

Type: 12 LED  
Material/dome: Acrylic  
Material/house: Cast aluminum  
Shape: Oval  
2 poles: w/  
Tightness norm: IP 69K  
Approvals: CE/EMC

**172045 LED Work Lamp**



Voltage: 10-80  
Watt: 65  
Kelvin: 6000  
Lumen: 5850

Dim.: 165x142x94.5 mm

Type: 13 LED  
Colour: Black  
Material/ bracket: Stainless steel  
Material/dome: Polycarbonate  
Material/house: Aluminium  
Shape: Oval  
2 poles: w/  
Tightness norm: IP 69K  
Approvals: CE

**172046 LED Work Lamp**

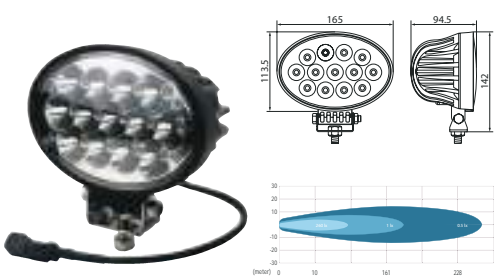

Voltage: 10-80  
Watt: 65  
Kelvin: 6000  
Lumen: 5850

Dim.: 165x142x94.5 mm

Type: 13 LED  
Colour: Black  
Material/ bracket: Stainless steel  
Material/dome: Polycarbonate  
Material/house: Aluminium  
Shape: Oval  
2 poles: w/  
Tightness norm: IP 69K  
Approvals: CE

**172053 LED Blue Spot**



Voltage: 10-80  
Amp: 0.5/0.25  
Watt: 6  
Lumen: 540

Dim.: 92.4x49.6x45.7 mm  
Cable length: 500 mm

Type: 2 LED  
Colour: Blue  
Material/ bracket: Stainless steel  
Material/dome: Polycarbonate  
Material/house: Cast aluminum  
Shape: Rectangular  
Mount. bracket: U-bracket w/ 1 bolt  
2 poles: w/  
Tightness norm: IP 69K  
Approvals: CE

**172054 LED Red Spot**



Voltage: 10-80  
Amp: 0.5/0.25  
Watt: 6  
Lumen: 540

Dim.: 92.4x49.6x45.7 mm  
Cable length: 500 mm

Type: 2 LED  
Colour: Red  
Material/ bracket: Stainless steel  
Material/dome: Polycarbonate  
Material/house: Cast aluminum  
Shape: Rectangular  
Mount. bracket: U-bracket w/ 1 bolt  
2 poles: w/  
Tightness norm: IP 69K  
Approvals: CE

**172055 LED Work Lamp**

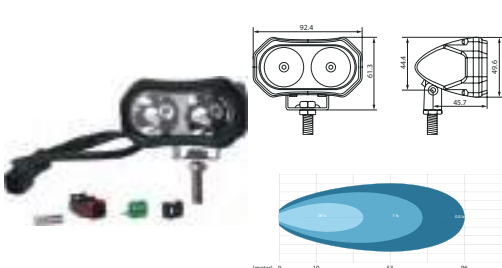

Voltage: 10-80  
Amp: 0.83/0.42  
Watt: 10  
Kelvin: 6000  
Lumen: 900

Dim.: 92.4x49.6x45.7 mm  
Cable length: 500 mm

Type: 2 LED  
Material/ bracket: Stainless steel  
Material/dome: Polycarbonate  
Material/house: Cast aluminum  
Shape: Rectangular  
Mount. bracket: U-bracket w/ 1 bolt  
2 poles: w/  
Tightness norm: IP 69K  
Approvals: CE



**172056 LED Work Lamp**

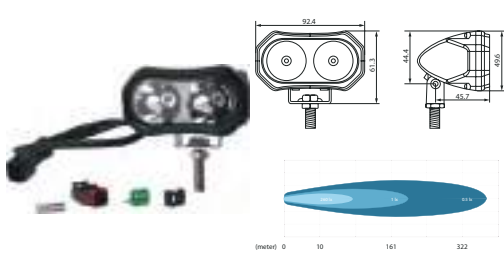

Voltage: 10-80  
Amp: 0.83/0.42  
Watt: 10  
Kelvin: 6000  
Lumen: 900

Dim.: 92.4x49.6x45.7 mm  
Cable length: 500 mm

Type: 2 LED  
Material/ bracket: Stainless steel  
Material/dome: Polycarbonate  
Material/house: Cast aluminum  
Shape: Rectangular  
Mount. bracket: U-bracket w/ 1 bolt  
2 poles: w/  
Tightness norm: IP 69K  
Approvals: CE

**172088 LED Work Lamp**

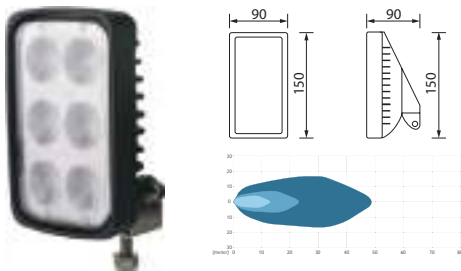

Voltage: 10-30  
Watt: 30  
Kelvin: 6000  
Lumen: 2400

Cable length: 350 mm

Bulb type: 6 LED  
Material/dome: Polycarbonate  
Material/house: Aluminium  
Shape: Rectangular  
Mount.: Sidemounted  
2 poles: w/  
Tightness norm: IP 69K  
Approvals: CE/EMC

**172105 LED Work Lamp**

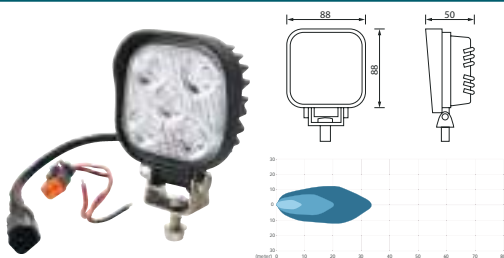

Voltage: 10-30  
Watt: 15  
Kelvin: 6000  
Lumen: 1200

Dim.: 88x88x50 mm  
Cable length: 450 mm

Bulb type: 5 LED  
Colour: Black  
Material/dome: Polycarbonate  
Material/house: Aluminium  
2 poles: Male/female  
Tightness norm: IP 69K  
Approvals: CE/EMC

**172106 LED Work Lamp**

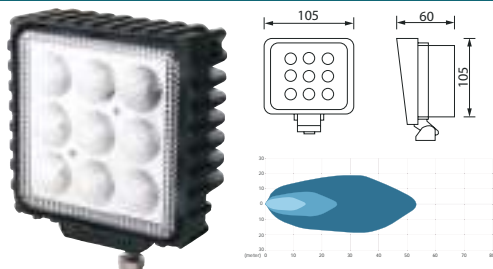

Voltage: 10-30  
Watt: 27  
Kelvin: 6000  
Lumen: 2160

Dim.: 105x105x60 mm  
Cable length: 450 mm

Bulb type: 9 LED  
Colour: Black  
Material/dome: Polycarbonate  
Material/house: Aluminium  
2 poles: Male/female  
Tightness norm: IP 69K  
Approvals: CE/EMC

**172107 LED Work Lamp**

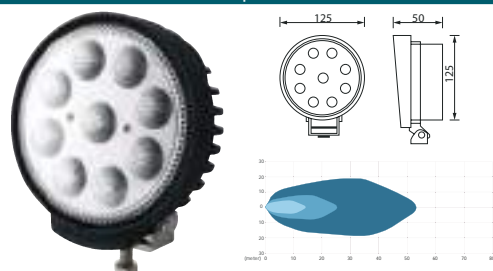

Voltage: 10-30  
Watt: 27  
Kelvin: 6000  
Lumen: 2160

Dim.: 125x125x50 mm  
Cable length: 450 mm

Bulb type: 9 LED  
Colour: Black  
Material/dome: Polycarbonate  
Material/house: Aluminium  
2 poles: Male/female  
Tightness norm: IP 69K  
Approvals: CE/EMC

**WORK LIGHT BARS LED**

**172077 LED Work light bar**

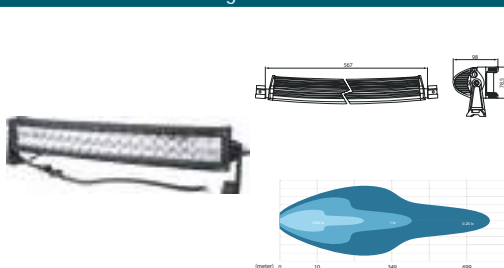

Voltage: 10-30  
Watt: 120  
Kelvin: 6000  
Lumen: 10800

Dim.: 567x98x78.5 mm  
Cable length: 1000 mm

Bulb type: 40 LED  
Colour: Black  
Material/ bracket: Aluminium  
Material/dome: Polycarbonate  
Material/house: Aluminium  
Reflector system: Combo  
Shape: Curved  
Mount. bracket: Vertical  
2 poles: Male/female  
Tightness norm: IP 69K  
Approvals: CE/EMC  
E-approval: No

**172078 LED Work light bar**

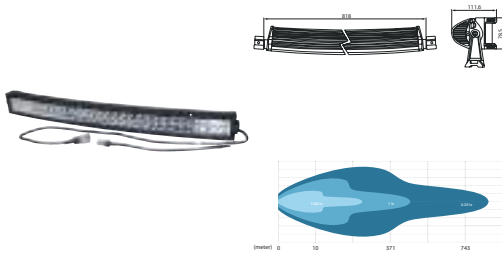

Voltage: 10-30  
Watt: 180  
Kelvin: 6000  
Lumen: 16200

Dim.: 818x111.6x78.5 mm  
Cable length: 1000 mm

Bulb type: 60 LED  
Colour: Black  
Material/ bracket: Aluminium  
Material/dome: Polycarbonate  
Material/house: Aluminium  
**Reflector system:** Combo  
Model: LED  
Shape: Curved  
Mount. bracket: Vertical  
2 poles: Male/female  
Tightness norm: IP 69K  
Approvals: CE/EMC  
E-approval: No

**172079 LED Work light bar**

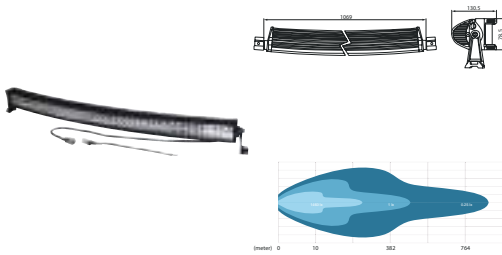

Voltage: 10-30  
Watt: 240  
Kelvin: 6000  
Lumen: 21600

Dim.: 1069x130.5x78.5 mm  
Cable length: 1000 mm

Bulb type: 80 LED  
Colour: Black  
Material/ bracket: Aluminium  
Material/dome: Polycarbonate  
Material/house: Aluminium  
**Reflector system:** Combo  
Model: LED  
Shape: Curved  
Mount. bracket: Vertical  
2 poles: Male/female  
Tightness norm: IP 69K  
Approvals: CE/EMC  
E-approval: No

**172080 LED Work light bar**

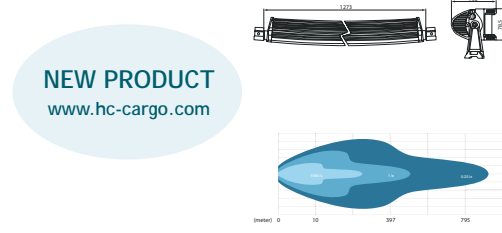

**NEW PRODUCT**  
[www.hc-cargo.com](http://www.hc-cargo.com)

Voltage: 10-30  
Watt: 288  
Kelvin: 6000  
Lumen: 25920

Dim.: 1273x150x78.5 mm  
Cable length: 1000 mm

Bulb type: 96 LED  
Colour: Black  
Material/ bracket: Aluminium  
Material/dome: Polycarbonate  
Material/house: Aluminium  
**Reflector system:** Combo  
Model: LED  
Shape: Curved  
Mount. bracket: Vertical  
2 poles: Male/female  
Tightness norm: IP 69K  
Approvals: CE/EMC  
E-approval: No

**172081 LED Work light bar**

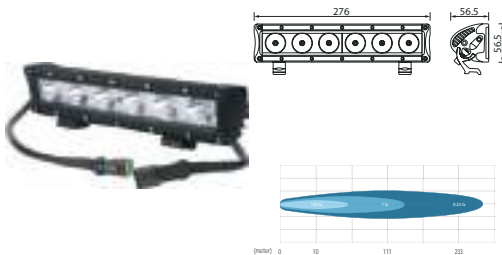

Voltage: 10-30  
Watt: 18  
Kelvin: 6000  
Lumen: 1620

Dim.: 276x56.6x56.5 mm  
Cable length: 500 mm

Bulb type: 6 LED  
Colour: Black  
Material/ bracket: Aluminium  
Material/dome: Polycarbonate  
Material/house: Aluminium  
**Reflector system:** Spot  
Model: LED  
Shape: Straight  
Mount. bracket: Vertical  
2 poles: Male/female  
Tightness norm: IP 69K  
Approvals: CE/EMC  
E-approval: No

**172082 LED Work light bar**

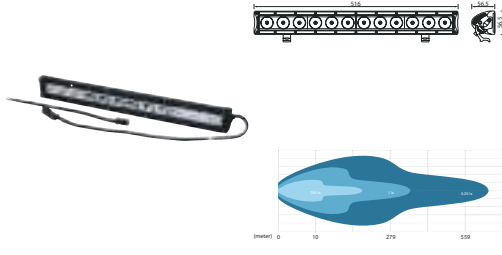

Voltage: 10-30  
Watt: 36  
Kelvin: 6000  
Lumen: 3240

Dim.: 516x56.5x56.5 mm  
Cable length: 500 mm

Bulb type: 12 LED  
Colour: Black  
Material/ bracket: Aluminium  
Material/dome: Polycarbonate  
Material/house: Aluminium  
**Reflector system:** Combo  
Model: LED  
Shape: Straight  
Mount. bracket: Vertical  
2 poles: Male/female  
Tightness norm: IP 69K  
Approvals: CE/EMC  
E-approval: No

172083 LED Work light bar		EL. SPECIFICATIONS	DIMENSIONS	ADDITIONAL SPECIFICATIONS
	<p>Voltage: 10-30 Watt: 54 Kelvin: 6000 Lumen: 4860</p>	<p>Dim.: 756x56.5x56.5 mm Cable length: 500 mm</p>	<p>Bulb type: 18 LED Colour: Black Material/ bracket: Aluminium Material/dome: Polycarbonate Material/house: Aluminium Reflector system: Combo Model: LED Shape: Straight Mount. bracket: Vertical 2 poles: Male/female Tightness norm: IP 69K Approvals: CE/EMC E-approval: No</p>	
172084 LED Work light bar		EL. SPECIFICATIONS	DIMENSIONS	ADDITIONAL SPECIFICATIONS
	<p>Voltage: 10-30 Watt: 72 Kelvin: 6000 Lumen: 6480</p>	<p>Dim.: 996x56.5x56.5 mm Cable length: 500 mm</p>	<p>Bulb type: 24 LED Colour: Black Material/ bracket: Aluminium Material/dome: Polycarbonate Material/house: Aluminium Reflector system: Combo Model: LED Shape: Straight Mount. bracket: Vertical 2 poles: Male/female Tightness norm: IP 69K Approvals: CE/EMC E-approval: No</p>	
172095 LED Work light bar		EL. SPECIFICATIONS	DIMENSIONS	ADDITIONAL SPECIFICATIONS
<p><b>NEW PRODUCT</b> <a href="http://www.hc-cargo.com">www.hc-cargo.com</a></p>	<p>Voltage: 12/24 Amp: 3.2/1.6 Watt: 40 Kelvin: 6000 Lumen: 4000</p>	<p>Dim.: 255x80x41 mm Cable length: 220 mm</p>	<p>Type: 10 LED Bulb type: 10 LED Inclination/downwards: 90° Inclination/upwards: 15° Colour: Black Material/ bracket: Stainless steel Material/dome: Polycarbonate Material/house: Aluminium Reflector system: Spot Shape: Straight Mount.: Upright/pendant Mount. bracket: Sidemounted 2 poles: Male/female Tightness norm: IP 65 Approvals: CE/EMC E-approval: No</p>	
172096 LED Work light bar		EL. SPECIFICATIONS	DIMENSIONS	ADDITIONAL SPECIFICATIONS
	<p>Voltage: 12/24 Amp: 6.25/3.125 Watt: 75 Kelvin: 6000 Lumen: 8000</p>	<p>Dim.: 550x80x41 mm Cable length: 220 mm</p>	<p>Type: 20 LED Bulb type: 20 LED Inclination/downwards: 90° Inclination/upwards: 15° Colour: Black Material/ bracket: Stainless steel Material/dome: Polycarbonate Material/house: Aluminium Reflector system: Spot Shape: Straight Mount.: Upright/pendant Mount. bracket: Sidemounted 2 poles: Male/female Tightness norm: IP 65 Approvals: CE/EMC E-approval: No</p>	
172097 LED Work light bar		EL. SPECIFICATIONS	DIMENSIONS	ADDITIONAL SPECIFICATIONS
	<p>Voltage: 12/24 Amp: 9.45/4.7 Watt: 115 Kelvin: 6000 Lumen: 12000</p>	<p>Dim.: 805x80x41 mm Cable length: 3000 mm</p>	<p>Type: 30 LED Bulb type: 30 LED Inclination/downwards: 90° Inclination/upwards: 15° Colour: Black Material/ bracket: Stainless steel Material/dome: Polycarbonate Material/house: Aluminium Reflector system: Spot Shape: Straight Mount.: Upright/pendant Mount. bracket: Sidemounted 2 poles: Male/female Tightness norm: IP 65 Approvals: CE/EMC E-approval: No</p>	

**172098 LED Work light bar**

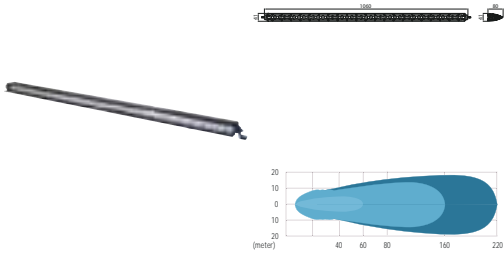

Voltage: 12/24  
Amp: 12.5/6.25  
Watt: 150  
Kelvin: 6000  
Lumen: 16000

Dim.: 1060x80x41 mm  
Cable length: 3000 mm

Type: 40 LED  
Bulb type: 40 LED  
Inclination/downwards: 90°  
Inclination/upwards: 15°  
Colour: Black  
Material/ bracket: Stainless steel  
Material/dome: Polycarbonate  
Material/house: Aluminium  
Reflector system: Spot  
Shape: Straight  
Mount.: Upright/pendant  
Mount. bracket: Sidemounted  
2 poles: Male/female  
Tightness norm: IP 65  
Approvals: CE/EMC  
E-approval: No

**ACCESSORIES**

**172005 Bracket**

Servicing: HC-CARGO 171955, 172003, 172004



Dim.: 59x37 mm  
Mount. hole size:  
24 mm

Material: Plastic  
Mount.: Standard ISO A - Rod

**172008 Handle for LED Work Lamp**

Servicing: HC-CARGO 171948, 171949, 171950, 171951, 172001



Colour: Black  
Material/ bracket: Aluminium  
Mount. bracket: 2 screws

**WORK LAMPS HID**

**171611 HID Work Lamp**

Bulb: HC-CARGO 171595.

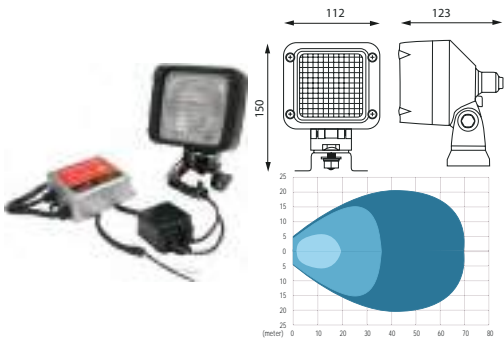

Bulb incl.: Yes  
Voltage: 24

Dim.: 112x150x123 mm  
Light aperture:  
73x73 mm

Type: H3  
Colour: Black  
Material/dome: Glass  
Material/house: Shockproof plastic  
Model: HID  
Shape: Square  
Switch: w/o  
Ballast: External  
Mount. bracket: Mounting bracket  
Magnet base: w/o  
Handle: w/o  
2 poles: w/  
Tightness norm: IP 65

**171626 HID Work Lamp**

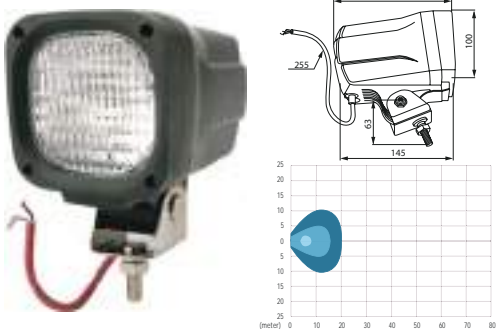

Bulb incl.: Yes  
Voltage: 24  
Watt: 35

Dim.: 156x100 mm  
Light aperture: 75 mm

Type: D2S  
Socket type: PK32d-3  
Colour: Black  
Material/dome: Glass  
Material/house: Aluminium  
Reflector system: Single  
Shape: Square  
Mount.: Single bolt fixing  
Switch: w/o  
Mount. bracket: Mounting bracket  
Magnet base: w/o  
Handle: w/o  
2 poles: w/o

**SPARE PARTS**
**171595** Xenon Bulb

Servicing: HC-CARGO 171594

 Type: Xenon  
H3

**BEACON SOCKETS**
**170292** Beacon Socket

Length: 100 mm

 Material: Steel  
Mount.: Weld  
Bracket: Straight  
Socket: DIN 72591 1 terminal

**170387** Beacon Socket

 Material: Electro galvanized  
Mount.: w/ nuts  
Bracket: Straight  
Socket: DIN 72591 1 terminal

**170405** Beacon Socket

 Length: 108 mm  
Mount. hole size:  
10 mm

 Material: Galvanized steel  
Mount.: Flat  
Bracket: Angled 90°  
Socket: DIN 72591 2 terminal

**170406** Beacon Socket

 Material: Galvanized steel  
Mount.: 2 screws  
Bracket: Adjustable  
Socket: DIN 72591 2 terminal

**170419** Beacon Socket

 Material: Galvanized steel  
Mount.: Vertical  
Bracket: Angled 90°  
Socket: DIN 72591 2 terminal



170531 Extension		Servicing: Mercedes-Benz	
		Length: 500 mm Mount. hole size: 24 mm	Material: Galvanized steel Bracket: Straight Socket: DIN 72591 2 terminal
170537 Beacon Socket			Material: Electro galvanized Mount.: Vertical Bracket: Straight Socket: DIN 72591 2 terminal
			
170562 Beacon Socket			Material: Galvanized steel Mount.: 2 screws Bracket: Angled 90° Socket: DIN 72591 2 terminal
			
170788 Beacon Socket		Length: 102 mm Mount. hole size: 10 mm	Material: Electro galvanized Mount.: Flat Bracket: Angled Socket: DIN 72591 1 terminal
			
170789 Beacon Socket			Material: Electro galvanized Bracket: Adjustable Socket: DIN 72591 1 terminal
			
171576 Beacon Socket		Servicing: IH/CASE	
			Material: Steel Mount.: Vertical Bracket: Straight Socket: DIN 72591 2 terminal



# Bulbs

Edition 2016/2017



H1 Halogen									
	HC-CARGO	Voltage	Watt	Length	OD	Colour	Type	Comment	
 P14.5s	171072	24	70	62.5 mm	8.5 mm		Single filament, Halogen		
H2 Halogen									
	HC-CARGO	Voltage	Watt	Length	OD	Colour	Type	Comment	
 X511	170512	24	100	30 mm	9 mm		Single filament, Halogen		
H3 Halogen									
	HC-CARGO	Voltage	Watt	Length	OD	Colour	Type	Comment	
 PK22s	170836	24	70	42 mm	11.5 mm		Single filament, Halogen		
	171407	48	45	42 mm	11.5 mm		Halogen		
	171378	80	55	42 mm	11.5 mm		Halogen		
	HC-CARGO	Voltage	Watt	Length	OD	Colour	Type	Comment	
 PK22s	170362	24	100	42 mm	11.5 mm		Single filament, Halogen		
	170412	24	70	42 mm	11.5 mm		Single filament, Halogen		
H4 Halogen									
	HC-CARGO	Voltage	Watt	Length	OD	Colour	Type	Comment	
 P43t	170515	24	130/90	78 mm	16 mm		Double filament, Halogen		
	170792	24	75/70	78 mm	16 mm		Double filament, Halogen		
	171125	24	75/70	78 mm	16 mm		Double filament, Halogen, Heavy Duty		
	HC-CARGO	Voltage	Watt	Length	OD	Colour	Type	Comment	
 P43t	170360	24	100/70	78 mm	16 mm		Halogen		
	170348	24	75/70	78 mm	16 mm		Halogen		
	170450	24	75/70	78 mm	16 mm		Halogen, Heavy Duty		
 P45t	170006	24	75/70	78 mm	16 mm		Halogen		
H7 Halogen									
	HC-CARGO	Voltage	Watt	Length	OD	Colour	Type	Comment	
 PX26d	171080	24	70	58 mm	11.6 mm		Single filament, Halogen		
	171532	24	70	58 mm	11.6 mm		Halogen, Longlife		

	HC-CARGO	Voltage	Watt	Length	OD	Colour	Type	Comment
 PX26d	170800	24	70	58 mm	11.6 mm		Single filament, Halogen	
<b>H11 American Types</b>								
	HC-CARGO	Voltage	Watt	Length	OD	Colour	Type	Comment
 PGJ19-2	172073	24	70	44 mm			American, Halogen	
<b>H21W Halogen</b>								
	HC-CARGO	Voltage	Watt	Length	OD	Colour	Type	Comment
 BAY9s	171084	24	21	40 mm	10 mm		Halogen	
<b>Stop and Tail Lamps</b>								
	HC-CARGO	Voltage	Watt	Length	OD	Colour	Type	Comment
 BAY15d	170452	24	21/5	52.5 mm	26.5 mm			
 BAZ15d	170850	24	21/4	52.5 mm	26.5 mm			
<b>Festoon</b>								
	HC-CARGO	Voltage	Watt	Length	OD	Colour	Type	Comment
 S8.5	171100	24	10	41 mm	10.5 mm		Festoon	
	171096	24	5	36 mm	10.5 mm		Festoon	
	171099	24	5	41 mm	10.5 mm		Festoon	
	HC-CARGO	Voltage	Watt	Length	OD	Colour	Type	Comment
 S8.5	170592	24	15	41 mm	15 mm		Festoon	
	170589	24	18	41 mm	15 mm		Festoon	
	170414	24	5	36 mm	10.5 mm		Festoon, C5W	
<b>Parking and Flasher - Postion</b>								
	HC-CARGO	Voltage	Watt	Length	OD	Colour	Type	Comment
 BA15d	171102	24	5	35 mm	18.5 mm			
 BA15S	170794	24	5	35 mm	18.5 mm			
	171118	24	5	35 mm	18.5 mm			

	HC-CARGO	Voltage	Watt	Length	OD	Colour	Type	Comment
 BA9s	170796	24	2	23 mm	8.6 mm			
	170795	24	4	27.4 mm	8.6 mm			
	HC-CARGO	Voltage	Watt	Length	OD	Colour	Type	Comment
 BA15S	170413	24	5	35 mm	18.5 mm		R5W	
	170455	24	5	35 mm	18.5 mm			
 BA7s	170456	24	3	20.7 mm	6.8 mm			
 BA9s	170416	24	2	23 mm	8.6 mm		T2W	
	170417	24	4	27.4 mm	8.6 mm		T4W	
Stop and Flasher - Position								
	HC-CARGO	Voltage	Watt	Length	OD	Colour	Type	Comment
 BA15d	171088	24	15	43 mm	23 mm			
	171982	24	20	45 mm	26.5 mm			
 BA15S	170793	24	10	35 mm	18 mm			
	171076	24	10	35 mm	18 mm			
	171086	24	15	43 mm	23 mm			
	170826	24	21	52.5 mm	26.5 mm			
	171078	24	21	52.5 mm	26.5 mm			
 BAU15s	171986	24	25	45 mm	26.5 mm			
	171090	24	21	50 mm	25 mm	Orange		
	HC-CARGO	Voltage	Watt	Length	OD	Colour	Type	Comment
 BA15d	170481	24	20	45 mm	26.5 mm			
 BA15S	170351	24	10	35 mm	19 mm		R10W	
	170454	24	10	35 mm	15 mm			
	170349	24	21	52.5 mm	26.5 mm		P21W	
	170451	24	21	52.5 mm	26.5 mm			
 BAU15s	170614	24	25	45 mm	26.5 mm			
	170849	24	21	52.5 mm	26.5 mm	Orange		
Wedge Base								
	HC-CARGO	Voltage	Watt	Length	OD	Colour	Type	Comment
 T10	171106	24	3	26 mm	10 mm			
	171107	24	5	26 mm	10 mm			



	HC-CARGO	Voltage	Watt	Length	OD	Colour	Type	Comment
 T5	171108	24	1.2	20 mm	5 mm			
 T10	171027	24	2	26.7 mm	10.3 mm			
 T10	170476	24	3	26.7 mm	10.3 mm		W3W	
	170805	24	3	26.7 mm	10.3 mm	Orange	W3W	
	170806	24	3	26.7 mm	10.3 mm	Green	W3W	
	170807	24	3	26.7 mm	10.3 mm	Blue	W3W	
	170808	24	3	26.7 mm	10.3 mm	Red	W3W	
	170542	24	5	26.7 mm	10.3 mm		W5W	
 T5	170684	24	0.7	20 mm	5 mm			
	170477	24	1.2	20 mm	5 mm			
<b>Wedge Base - Covers</b>								
 T10	170731					Blue		
	170732					Green		
	171127					Orange		
	171128					Blue		
	171129					Green		
	171130					Red		
	171131					Orange		
<b>Conventional</b>								
 BA15S	171978	24	45	53 mm	36 mm		Conventional	For US and UK systems.
 BA20d	171976	24	45/40	70 mm	36 mm		Conventional	

	HC-CARGO	Voltage	Watt	Length	OD	Colour	Type	Comment
 BA15S	170578	24	45	53 mm	36 mm		Conventional	For US and UK systems.
 BA20d	170574	24	45/40	70 mm	36 mm		Conventional	
 P45t	170350	24	55/50	77 mm	41 mm		Conventional, Bilux	
Electric Vehicles and Forklifts								
	HC-CARGO	Voltage	Watt	Length	OD	Colour	Type	Comment
 BA15S	171410	48	10	35 mm	16 mm			
	171408	48	25	50 mm	25 mm			
 BAY15d	171411	48	25/10	50 mm	25 mm			
Halogen								
	HC-CARGO	Voltage	Watt	Length	OD	Colour	Type	Comment
 G4	170848	24	10	30 mm	8 mm		Halogen	
	170750	24	20	30 mm	8 mm		Halogen	
Instrument Panel								
	HC-CARGO	Voltage	Watt	Length	OD	Socket colour	Type	Comment
 B8.5d	171028	24	1.2	21 mm	5 mm	Brown		
 EBSN10	171377	24	1.2	20 mm	6 mm	Beige		Alba- type.
 EBSR11	171025	24	1.2	21 mm	5 mm	Yellow		Alba- type.
	171026	24	1.2	21 mm	5 mm	Brown		Alba- type.
	171032	24	1.4	21 mm	5 mm	Green		Alba- type.
 MFJF	171837	12	2	35 mm	5 mm	Black		

	HC-CARGO	Voltage	Watt	Length	OD	Socket colour	Type	Comment
 T5	171029	24	1.2	20 mm	5 mm	White		
	HC-CARGO	Voltage	Watt	Length	OD	Colour	Type	Comment
 B8.3d	170613	24	1.2	23.5 mm	5 mm	Grey		
 B8.5d	170358	24	1.2	23.5 mm	5 mm	Grey		

## Spare Lamp Kits

## For Trucks and Buses



Contains:

H4

HC-CARGO	TYPE	Jahn Ref. No.	Description	171044
170348	H4	1102	24 V. 75/70W P43t.	2
170417	T4W	1502	24 V. 4 W. BA9s.	2
170413	R5W	1402	24 V. 5 W. BA15s.	1
170351	R10W	1412	24 V. 10 W. BA15s.	1
170349	P21W	1322	24 V. 21 W. BA15s.	4
170416	T2W	1512	24 V. 2 W. BA9s.	2
170475	Fest. T10.5	1732	24 V. 10 W. SV8.5.	1
170414	C5W	1712	24 V. 5 W. SV8.5.	1
190057	ATO blade fuse		10 Amp. Red.	1
190058	ATO blade fuse		15 Amp. Blue.	1
190059	ATO blade fuse		20 Amp. Yellow.	1
190060	ATO blade fuse		25 Amp. Natural.	1



171044

Dimensions: 210 x 95 x 60 mm.





# Electrical Components

Edition 2016/2017

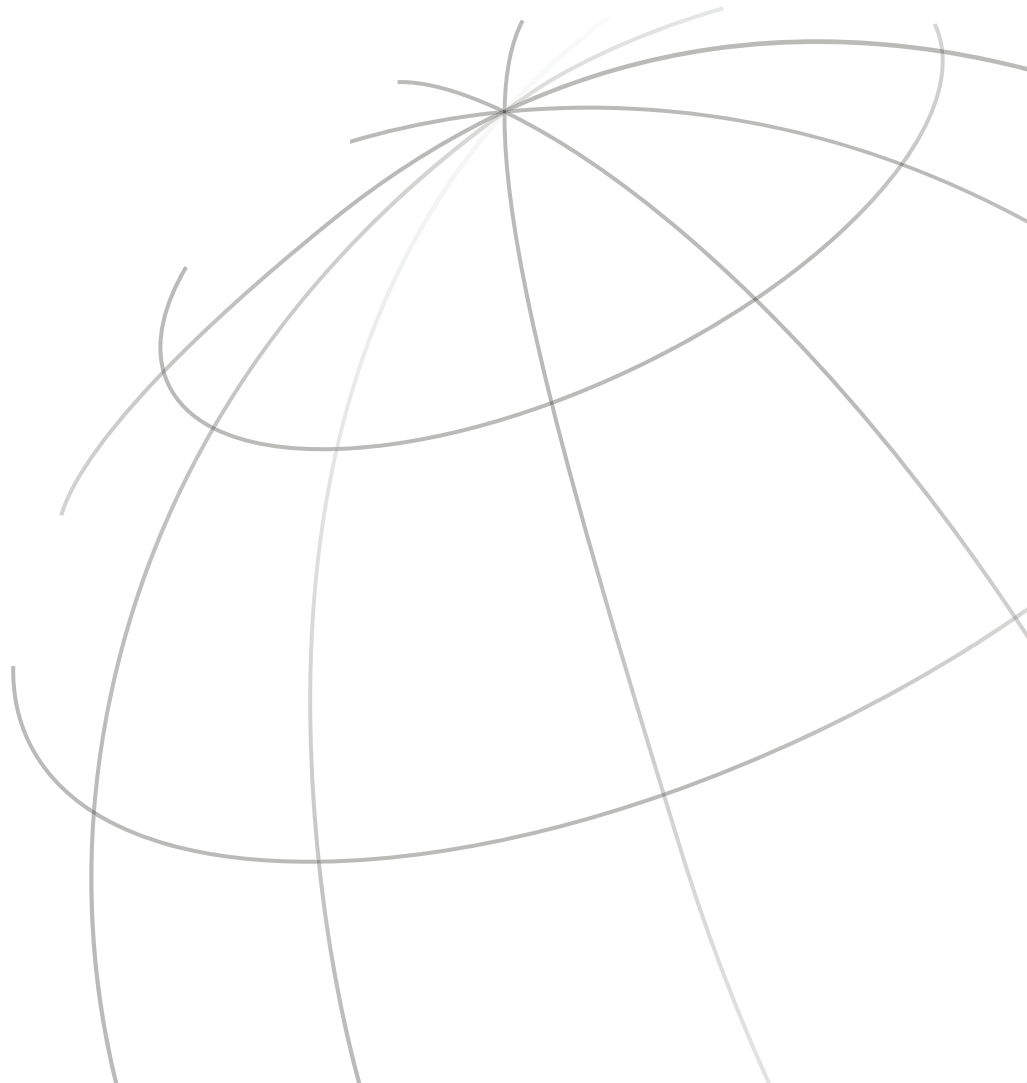



## ACOUSTIC WARNING

### BUZZERS

#### 160533 Warning Buzzer



Voltage: 24  
Miliamp: 21  
Decibel: 99  
Hertz: 400±100

### HORNS

#### AIR HORNS

#### 160039 Electric Valve

For Compressor horn.



Voltage: 24

#### 160048 Marine Horn

To be powered by electric air compressor HC-CARGO 160213. Audibility at least 1600 mtr. over open water.



Decibel: 120  
Hertz: 380

Length: 385 mm  
Capacity: 72 l/min

Material: Stainless steel  
Marine: Yes

#### 160508 Compressor Horn



Voltage: 24  
Amp: 8  
Decibel: 118  
Hertz: 692-756

Type: Dual tone  
Material: Shockproof plastic  
Relay: w/  
E-approval: Yes

#### 160632 Marine Air Horn



Voltage: 24  
Decibel: 117  
Hertz: 228

Length: 500 mm

Material: Stainless steel  
Marine: Yes

## ELECTRICAL

#### 160393 Horn

2 terminals. w/ bracket.



Voltage: 36-48  
Amp: 1  
Decibel: 112  
Hertz: 420

OD: 100 mm

Type: Single tone  
Material: Steel  
Marine: No  
E-approval: Yes

**160414** Horn

Model EM2.

 Voltage: 24  
 Amp: 4  
 Decibel: 118  
 Hertz: 370

Length: 400 mm

 Type: Single tone  
 Material: Chromed brass  
 Relay: w/o  
 Marine: Yes

**160987** Horn

2 terminals. w/ bracket.

 Voltage: 24  
 Amp: 2.5  
 Decibel: 112  
 Hertz: 420

OD: 90 mm

 Type: Single tone  
 Material: Steel  
 Marine: No  
 E-approval: Yes

**160989** Horn

2 terminals. w/ bracket.

 Voltage: 24  
 Amp: 2.5  
 Decibel: 112  
 Hertz: 335

OD: 90 mm

 Type: Single tone  
 Material: Steel  
 Marine: No  
 E-approval: Yes

**REVERSING ALARMS**
**160410** Reversing Alarm

w/ "beep-beep" warning sound.

 Voltage: 24  
 Watt: 20  
 Decibel: 90

 Bulb type: Halogen  
 Socket type: BA15S  
 ADR-approved: No

**160481** Reversing Alarm

 Voltage: 12/24  
 Amp: 0.25  
 Decibel: 96  
 Hertz: 2500

 Overvoltage: Yes  
 Waterproof: Yes  
 ADR-approved: No

**160482** Reversing Alarm

Night attenuation, excluding when fog lights are on. RED LEAD- To reverse lamp, BLACK LEAD- To earth, ORANGE LEAD- To side lamp (night silent mode), GREEN LEAD- To fog lamp (night silent override).

 Voltage: 12/24  
 Amp: 0.25  
 Decibel: 100  
 Hertz: 980

 Overvoltage: Yes  
 Waterproof: Yes  
 ADR-approved: Yes

**160689** Reversing Alarm

 Voltage: 12/80  
 Milliamp: 30  
 Decibel: 85  
 Hertz: 3200

Weight: 0.035 kg

 Type: Buzzer  
 Waterproof: Yes  
 ADR-approved: No

## CABIN HEATERS

### 060220 Cabin Heater

The heater has three 75 mm tube connections on the air inlet side. There are also three 75 mm tube connections on the outlet side. The water connections can be placed on either side of the heater and also be turned towards either the inlet or the outlet side.

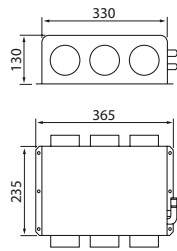

Voltage: 24  
Watt/speed 1: 60  
Watt/speed 2: 77  
Watt/speed 3: 114

Dim.: 330x230x130 mm  
Water connection OD: 16 mm  
Weight: 6.3 kg  
Capacity kW/speed 1: 7.2  
Airflow speed 1: 264 m<sup>3</sup>/h  
Capacity kW/speed 2: 9.2  
Airflow speed 2: 357 m<sup>3</sup>/h  
Capacity kW/speed 3: 12.2  
Airflow speed 3: 504 m<sup>3</sup>/h  
Regulation: Yes

Type: Complete kit  
Cabinet: Stainless steel

### 060233 Cabin Heater

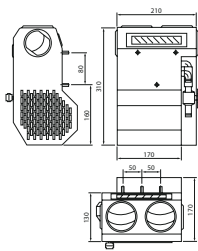

Voltage: 24  
Watt/speed 3: 230

Dim.: 310x210x130 mm  
Water connection OD: 16 mm  
Weight: 5.8 kg  
Capacity kW/speed 1: 4.3  
Airflow speed 1: 180 m<sup>3</sup>/h  
Capacity kW/speed 2: 6.3  
Airflow speed 2: 288 m<sup>3</sup>/h  
Capacity kW/speed 3: 9.2  
Airflow speed 3: 468 m<sup>3</sup>/h  
Regulation: Yes

Type: Complete kit  
Cabinet: Galvanized steel w/ black polyester

### 060235 Cabin Heater

Especially suitable for heating the passenger room in for instance buses.

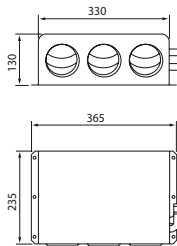

Voltage: 24  
Watt/speed 1: 60  
Watt/speed 2: 77  
Watt/speed 3: 114

Dim.: 365x235x130 mm  
Water connection OD: 16 mm  
Weight: 6.3 kg  
Capacity kW/speed 1: 7.2  
Airflow speed 1: 264 m<sup>3</sup>/h  
Capacity kW/speed 2: 9.3  
Airflow speed 2: 357 m<sup>3</sup>/h  
Capacity kW/speed 3: 12.2  
Airflow speed 3: 504 m<sup>3</sup>/h  
Regulation: Yes

Type: Complete kit  
Cabinet: Metal

## HEATER MOTORS

### 060214 Cabin Heater Motor

Servicing: HC-CARGO 060211

Heat-on 1531M-5024.



Voltage: 24  
Watt: 50

Dia.: 70 mm  
Shaft dia.: 6.35x16 mm  
Length: 63 mm  
Speed: 1-speed

Mount.: 3 holes  
No./shafts: 1  
Fan mounted: Yes

## CAMERA & PARKING SENSORS

### CCTV REAR OBSERVATION SYSTEM

#### 160775 Rear Observation Kit

Kit consisting of 1x7" monitor w/ quad: HC-CARGO 160776. 1x colour camera w/ audio: HC-CARGO 161038. 1x20 m extension cable: HC-CARGO 160611.



Voltage: 12/24

Extension cable: 20 m  
Height: 140 mm  
Depth: 50.8 mm  
Display size: 7"  
Width: 191 mm  
Wide angle: 60°

Monitor: LED  
Type: Camera kit  
Camera type: Colour  
Accessories: DVD  
No./cameras: 4+1  
Audio: Yes  
Extra camera: w/  
Infrared: w/  
Split screen: Yes  
Language: English

**160783** Rear Observation Kit

Kit consisting of 1x7" monitor: HC-CARGO 160784. 1x colour camera: HC-CARGO 161038. 1x20 m extension cable: HC-CARGO 160611.



Voltage: 12/24

Extension cable: 20 m  
 Height: 140 mm  
 Depth: 50.8 mm  
 Display size: 7"  
 Width: 191 mm  
 Wide angle: 60°

Monitor: LED  
 Type: Camera kit  
 Camera type: Colour  
 Accessories: DVD  
 No./cameras: 3+1  
 Remote control: w/o  
 Audio: Yes  
 Extra camera: w/  
 Infrared: w/  
 Split screen: Yes  
 Language: English

**160793** Rear View Mirror Monitor kit

w/o camera and extension cable. Camera: HC-CARGO 160610, 160880, 161038. Extension cables use: HC-CARGO 160611, 160612, 160613, 160672.



Voltage: 12/24

Display size: 4.3"

Camera type: Colour  
 Accessories: DVD  
 Audio: Yes

**160994** Rear Observation Kit

Consists: 1x7" monitor w/ remote control: HC-CARGO 160995. 1x colour camera: HC-CARGO 161043. 1x20 m extension cable: HC-CARGO 160888.



Voltage: 12-24

Extension cable: 20 m  
 Display size: 7"  
 Wide angle: 120°

Monitor: TFT-LCD  
 Type: Camera kit  
 Camera type: Colour  
 No./cameras: max. 2  
 Remote control: w/  
 Audio: Yes  
 Infrared: w/  
 Language: Chinese, German, English, French, Dutch, Italian, Japanese, Portuguese, Spanish

**160996** Rear Observation Kit

Consists: 1x5" monitor w/ remote control: HC-CARGO 161040. 1x colour camera: HC-CARGO 161043. 1x20 m extension cable: HC-CARGO 160888.



Voltage: 12-24

Extension cable: 20 m  
 Display size: 5"  
 Wide angle: 120°

Monitor: TFT-LCD  
 Type: Camera kit  
 Camera type: Colour  
 No./cameras: max. 2  
 Remote control: w/  
 Audio: Yes  
 Extra camera: w/  
 Infrared: w/  
 Language: Chinese, German, English, French, Dutch, Italian, Japanese, Portuguese, Spanish

**161007** Rear Observation Kit, Waterproof



Voltage: 12-24

Display size: 7"  
 Wide angle: 120°

Monitor: TFT-LCD  
 Type: Camera kit  
 Camera type: Colour  
 No./cameras: Max. 2  
 Remote control: w/  
 Audio: Yes  
 Infrared: w/  
 Tightness norm: IP 67  
 Language: Chinese, German, English, French, Dutch, Italian, Japanese, Portuguese, Spanish

**161027** Rear Observation Kit

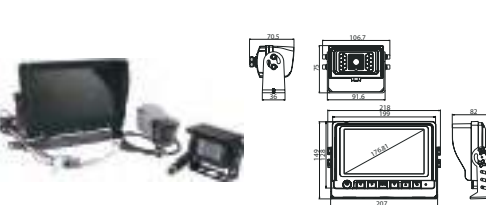
Consists: 1x7" monitor: HC-CARGO 161034. 1x colour camera: HC-CARGO 161028. 1x10 m extension cable: HC-CARGO 160889.



Voltage: 12-24

Extension cable: 10 m  
 Display size: 7"  
 Wide angle: 130°

Monitor: TFT-LCD  
 Type: Camera kit  
 Camera type: Colour  
 No./cameras: max. 2  
 Audio: No  
 Infrared: w/  
 Language: Chinese, German, English, French, Dutch, Italian, Portuguese, Spanish, Danish, Russian, Polish

**161031 Rear Observation Kit**

Consists: 1x7" monitor: HC-CARGO 161032. 2x colour camera: HC-CARGO 161033.

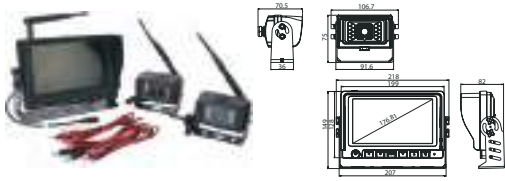

Voltage: 12-24

Display size: 7"  
Wide angle: 130°

Monitor: TFT-LCD  
Type: Camera kit  
Camera type: Colour - Wireless  
No./cameras: 2  
Audio: No  
Infrared: w/  
Split screen: Yes  
Language: English

**161039 Rear Observation Kit**

Monitor Mounting, W/suction Cup: HC-CARGO 161044. Consists: 1x5" monitor: HC-CARGO 161040. 1x colour camera: HC-CARGO 161043. 1x20 m extension cable: HC-CARGO 160888.



Voltage: 12-24

Extension cable: 20 m  
Display size: 5"  
Wide angle: 130°

Monitor: TFT-LCD  
Type: Camera kit  
Camera type: Colour  
No./cameras: max. 2  
Remote control: w/  
Audio: Yes  
Infrared: w/  
Split screen: No  
Language: Chinese, German, English, French, Dutch, Italian, Portuguese, Spanish, Danish, Russian, Polish

**161046 Rear Observation Kit**

Monitor Mounting, W/suction Cup: HC-CARGO 161044. Consists: 1x7" monitor: HC-CARGO 161047. 1x colour camera: HC-CARGO 161043. 1x15 m extension cable.

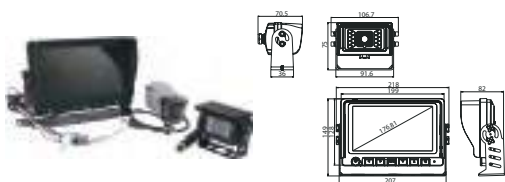

Voltage: 12-24

Extension cable: 15 m  
Display size: 7"  
Wide angle: 130°

Monitor: TFT-LCD  
Type: Camera kit  
Camera type: Colour  
No./cameras: max. 2  
Audio: Yes  
Infrared: w/  
Language: Chinese, German, English, French, Dutch, Italian, Portuguese, Spanish, Danish, Russian, Polish

**161051 Rear Observation Kit**

Monitor Mounting, W/suction Cup: HC-CARGO 161044. Consists: 1x7" monitor: HC-CARGO 161052. 1x colour camera: HC-CARGO 161043. 1x20 m extension cable: HC-CARGO 160888.

**NEW PRODUCT**  
[www.hc-cargo.com](http://www.hc-cargo.com)

Voltage: 12-24

Extension cable: 20 m  
Display size: 7"  
Wide angle: 120°

Monitor: TFT-LCD  
Type: Camera kit  
Camera type: Colour  
No./cameras: max. 4  
Remote control: w/  
Audio: Yes  
Infrared: w/  
Split screen: Yes  
Language: Chinese, German, English, French, Dutch, Italian, Spanish, Danish, Russian, Polish

**161054 Rear Observation Kit**

Monitor Mounting, W/suction Cup: HC-CARGO 161044. Consists: 1x5" monitor: HC-CARGO 161055. 2x colour camera: HC-CARGO 161058.



Voltage: 12-24

Height: 118 mm  
Depth: 69.5 mm  
Display size: 5"  
Width: 139 mm  
Wide angle: 120°

Monitor: TFT-LCD  
Type: Camera kit  
Camera type: Colour - Wireless  
No./cameras: 2  
Audio: Yes  
Infrared: w/  
Split screen: Yes  
Language: English

**CAMERAS**

**160610 CCTV Camera**

Servicing: HC-CARGO 160775, 160783, 160793

w/ original anoised finish and anti-fog glas.



Voltage: 12  
Light sensitivity: 0.2 lux

OD: 30 mm  
Length: 70 mm  
Connection cable: 6 pin mini DIN  
Weight: 0.200 kg  
Resolution: >330 TV lines  
Shutter rate: 1/50-1/100.000 sec.  
Wide angle: 110°

Signal system: PAL  
Type: Colour  
Colour: Black  
Material: Aluminium  
Picture sensor: 1/3" CCD  
Microphone: w/o  
Mirror function: w/  
Protection degree: IP 68



	EL. SPECIFICATIONS	DIMENSIONS	ADDITIONAL SPECIFICATIONS
<b>160880</b> Side Camera	Servicing: HC-CARGO 160775, 160783, 160793		
	Voltage: 12 Light sensitivity: 0 lux/ IR LED on lux	Connection cable: Mini DIN 6 pin - 2m Height: 60.7 mm Depth: 82.6 mm Width: 61.12 mm Resolution: 380 TV lines Shutter rate: 1/60- 1/100.000 sec. Wide angle: 73°	Signal system: PAL Type: Colour Colour: Black Material: Aluminium Picture sensor: 1/4" CCD Microphone: w/o Infrared: w/ Mirror function: w/ Protection degree: IP 67
<b>160887</b> Colour Camera	Servicing: HC-CARGO 160994, 160996		
	Voltage: 12/24 Light sensitivity: 0 lux	Connection cable: 0.3 m 4 pin Height: 43 mm Depth: 57 mm Width: 75 mm Resolution: 420 TV lines Wide angle: 120°	Signal system: PAL Type: Colour Colour: Black Material: Aluminium Picture sensor: 1/3" CCD Microphone: w/ Infrared: w/ Mirror function: w/ Protection degree: IP 68
<b>161006</b> Colour Camera w/ auto close	Servicing: HC-CARGO 160994, 161007, 161039, 161046, 161051		
	Voltage: 12 Light sensitivity: 0 lux	Connection cable: 0.5 m Resolution: 420 TV lines Wide angle: 140°	Signal system: PAL/NTSC Type: Colour Colour: Black Material: Aluminium Picture sensor: 1/3" CCD Microphone: w/o Infrared: w/ Protection degree: IP 68
<b>161029</b> Colour Camera w/ Heat. w/ heat.	Servicing: HC-CARGO 160994, 161007, 161039, 161046, 161051		
	Voltage: 12-24 Light sensitivity: 0 lux	Connection cable: 4 pin Height: 77.2 mm Depth: 66 mm Width: 77.2 mm Resolution: 420 TV lines Wide angle: 120°	Signal system: PAL Type: Colour Colour: Black Material: Aluminium Picture sensor: 1/3" CCD Microphone: w/o Infrared: w/ Mirror function: w/ Protection degree: IP 69K
<b>161030</b> Side Camera	Servicing: HC-CARGO 160994, 161007, 161039, 161046, 161051		
	Voltage: 12 Light sensitivity: 0 lux	Connection cable: 4 pin Height: 60 mm Depth: 90 mm Width: 75 mm Resolution: 420 TV lines Wide angle: 120°	Signal system: PAL Type: Colour Colour: Black Material: Aluminium Picture sensor: 1/3" CCD Microphone: w/o Infrared: w/ Mirror function: w/o Protection degree: IP 69K
<b>161038</b> Colour Camera w/ Audio	Servicing: HC-CARGO 160775, 160783, 160793		
	Voltage: 12 Light sensitivity: 0 lux	Connection cable: 1.3 m w/ 6 pin Mini DIN Height: 75 mm Depth: 60 mm Width: 90 mm Resolution: 420 TV lines Shutter rate: 1/50- 1/100.000 sec. Wide angle: 122°	Signal system: PAL/NTSC Type: Colour Colour: White Material: Aluminium Picture sensor: 1/3" CCD Microphone: w/ Audio: Yes Infrared: w/ Mirror function: w/ Protection degree: IP 68
<b>161041</b> Colour camera for roof mounting	Servicing: HC-CARGO 160994, 161007, 161039, 161046, 161051		
	Voltage: 12 Light sensitivity: 0 lux	Connection cable: 0.35 m 4 pin Height: 80 mm Depth: 215 mm Width: 135 mm Weight: 0.36 kg Resolution: 420 TV lines Wide angle: 120°	Signal system: PAL/NTSC Type: Colour Colour: Black Picture sensor: 1/3" CCD Microphone: w/o Infrared: w/ Protection degree: IP 66

<b>161043</b> Colour Camera		
Servicing: HC-CARGO 160994, 161007, 161039, 161046, 161051		
	Voltage: 12 Light sensitivity: 0 lux	Connection cable: 4 pin Height: 70 mm Depth: 84 mm Width: 76 mm Weight: 0.4 kg Resolution: 420 TV lines Wide angle: 120°
	Signal system: PAL Type: Colour Colour: Black Material: Aluminium Picture sensor: 1/3" CCD Microphone: w/ Audio: Yes Infrared: w/ Mirror function: w/ Protection degree: IP 69K	

<b>161050</b> Colour Camera		
Servicing: HC-CARGO 161048		
	Voltage: 12-24 Light sensitivity: 0 lux	Height: 75 mm Depth: 70.5 mm Width: 106.7 mm Resolution: 420 TV lines Wide angle: 120°
	Signal system: PAL/NTSC Type: Colour - Wireless Colour: Black Material: Aluminium Picture sensor: 1/4" CMOS Audio: Yes Infrared: w/ Mirror function: w/ Protection degree: IP 68	

<b>161058</b> Colour Camera		
Servicing: HC-CARGO 161054		
	Voltage: 12-24 Light sensitivity: 0 lux	Resolution: 500 TV lines Wide angle: 120°
	Signal system: PAL/NTSC Type: Colour - Wireless Colour: Black Material: Aluminium Picture sensor: 1/3" CMOS Audio: No Infrared: w/ Mirror function: w/ Protection degree: IP 69K	





## MONITORS

<b>160776</b> Monitor		
Servicing: HC-CARGO 160775		
	Voltage: 12/24	Display size: 7" Resolution: 1440x234 pixels
	Signal system: PAL/NTSC Type: LED Mount. bracket: w/ Loudspeaker: Yes Mirror function: w/ Language: English	

<b>160784</b> Monitor		
Servicing: HC-CARGO 160783		
	Voltage: 12/24	Display size: 7" Resolution: 1440(W) x 234(H) pixels
	Signal system: PAL/NTSC Type: TFT-LCD Mount. bracket: w/ Remote control: w/o Loudspeaker: Yes Mirror function: w/ Language: English	

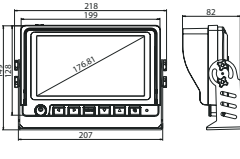
<b>160995</b> Monitor		
Servicing: HC-CARGO 160994, 161039, 161046		
	Voltage: 12-24	Display size: 7" Resolution: 400x234 pixels
	Signal system: PAL/NTSC Type: TFT-LCD Mount. bracket: w/ Remote control: w/ Loudspeaker: Yes Mirror function: w/o Language: Chinese, German, English, French, Dutch, Italian, Japanese, Portuguese, Spanish	

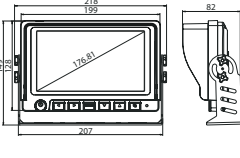
<b>160997</b> Monitor		
Servicing: HC-CARGO 160996		
	Voltage: 12-24	Display size: 5" Resolution: 400x234 pixels
	Signal system: PAL/NTSC Type: TFT-LCD Mount. bracket: w/ Remote control: w/ Loudspeaker: Yes Mirror function: w/o Language: Chinese, German, English, French, Dutch, Italian, Japanese, Portuguese, Spanish	

	EL. SPECIFICATIONS	DIMENSIONS	ADDITIONAL SPECIFICATIONS
<b>161032 Monitor</b>  	Servicing: HC-CARGO 161031 Voltage: 12-24	Display size: 7" Resolution: 800x480 pixels	Type: TFT-LCD Camera type: Colour - Wireless Mount. bracket: w/ Mirror function: w/ Language: English
<b>161034 Monitor</b>  	Servicing: HC-CARGO 161027 Voltage: 12-24	Display size: 7" Resolution: 800x480 pixels	Type: TFT-LCD Camera type: Colour Mount. bracket: w/ Loudspeaker: Yes Mirror function: w/ Language: Chinese, German, English, French, Dutch, Italian, Portuguese, Spanish, Danish, Russian, Polish
<b>161040 Monitor</b> 	Servicing: HC-CARGO 160994, 161039, 161046 Voltage: 12-24	Display size: 5" Resolution: 640x480 pixels	Type: TFT-LCD Mount. bracket: w/ Remote control: w/ Loudspeaker: Yes Mirror function: w/ Language: Chinese, German, English, French, Dutch, Italian, Portuguese, Spanish, Danish, Russian, Polish
<b>161047 Monitor</b> Servicing: HC-CARGO 160994, 161039, 161046 Monitor Mounting, W/suction Cup: HC-CARGO 161044.	Voltage: 12-24	Display size: 7" Resolution: 800x480 pixels	Type: TFT-LCD Camera type: Colour Mount. bracket: w/ Loudspeaker: Yes Audio: Yes Mirror function: w/ Language: Chinese, German, English, French, Dutch, Italian, Portuguese, Spanish, Danish, Russian, Polish
<b>161049 Monitor</b> Servicing: HC-CARGO 161048 Monitor Mounting, W/suction Cup: HC-CARGO 161044.	Voltage: 12-24	Display size: 7" Resolution: 800x400 pixels	Type: TFT-LCD Camera type: Colour - Wireless Mount. bracket: w/ Loudspeaker: Yes Audio: Yes Mirror function: w/ Language: English
<b>161052 Monitor</b> Servicing: HC-CARGO 161051 Monitor Mounting, W/suction Cup: HC-CARGO 161044.	Voltage: 12-24	Display size: 7" Resolution: 800x480 pixels	Type: TFT-LCD Camera type: Colour Mount. bracket: w/ Loudspeaker: Yes Audio: Yes Mirror function: w/ Language: Chinese, German, English, French, Dutch, Italian, Spanish, Danish, Russian, Polish
<b>161053 Monitor</b> Servicing: HC-CARGO 161051 Monitor Mounting, W/suction Cup: HC-CARGO 161044.	Voltage: 12-24	Display size: 7" Resolution: 800x480 pixels	Type: TFT-LCD Camera type: Colour Audio: No Mirror function: w/ Language: English

**161055 Monitor**

Servicing: HC-CARGO 161054

Monitor Mounting, W/suction Cup: HC-CARGO 161044.

**NEW PRODUCT**  
[www.hc-cargo.com](http://www.hc-cargo.com)

Voltage: 12-24

 Display size: 5"  
 Resolution:  
 800x480 pixels

 Type: TFT-LCD  
 Camera type: Colour - Wireless  
 Mount. bracket: w/  
 Audio: No  
 Mirror function: w/  
 Language: English

**ACCESSORIES**
**160611 CCTV Extension Cable**

Servicing: HC-CARGO 160775, 160783, 160793



Length: 20 m

Plug: Mini DIN 6 pin

**160612 CCTV Extension Cable**

Servicing: HC-CARGO 160775, 160783, 160793



Length: 15 m

Plug: Mini DIN 6 pin

**160613 CCTV Extension Cable**

Servicing: HC-CARGO 160775, 160783, 160793



Length: 10 m

Plug: Mini DIN 6 pin

**160672 CCTV Extension Cable**

Servicing: HC-CARGO 160775, 160783, 160793



Length: 6 m

Plug: Mini DIN 6 pin

**160888 CCTV Extension Cable**

Servicing: HC-CARGO 160994, 160996



Length: 20 m

Plug: 4 pin

**161036 Aerial**

Servicing: HC-CARGO 161031, 161032, 161033

 Colour: Black  
 Material: Rubber



**161044** Monitor Mounting, W/suction Cup

Servicing: HC-CARGO 161039

Suction.



Length: 220 mm

Colour: Black

**FANS & BLOWERS**

**AXIAL FANS**

**24 V**

**160584** Axial Fan



Voltage: 24  
Amp: 7.4

OD: 331 mm  
Capacity: 2900 m<sup>3</sup>

Type: Suction  
Fan mounted: Yes  
Tightness norm: IP 68

**160587** Axial Fan

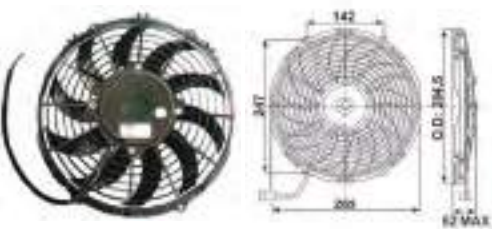

Voltage: 24  
Amp: 3.9

OD: 384.5 mm  
Capacity: 1300 m<sup>3</sup>

Type: Suction  
Tightness norm: IP 68

**160588** Axial Fan

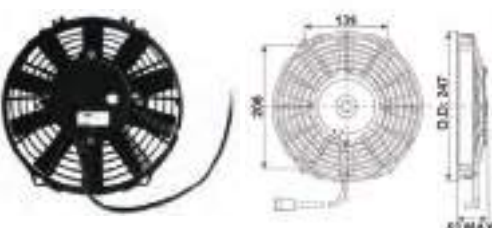

Voltage: 24  
Amp: 4.1

OD: 247 mm  
Capacity: 1080 m<sup>3</sup>

Type: Blower  
Fan mounted: Yes  
Tightness norm: IP 68

**160595** Axial Fan

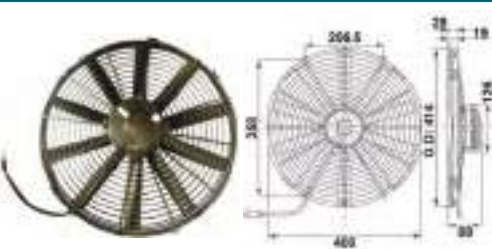

Voltage: 24  
Amp: 8.7

OD: 414 mm  
Capacity: 3540 m<sup>3</sup>

Type: Blower  
Tightness norm: IP 68

**160597** Axial Fan

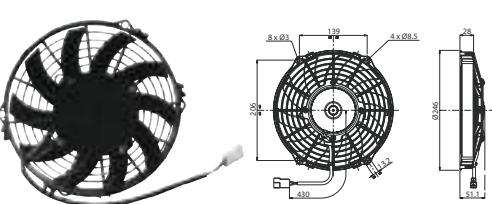

Voltage: 24  
Amp: 3.9

OD: 247 mm  
Capacity: 1180 m<sup>3</sup>

Type: Blower  
Fan mounted: Yes  
Tightness norm: IP 68

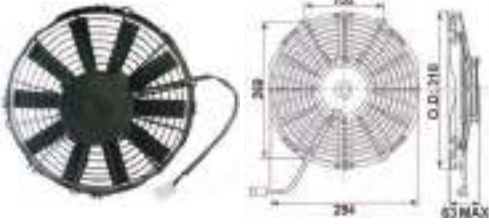

**160599 Axial Fan**

 Voltage: 24  
Amp: 4.4

 OD: 310 mm  
Capacity: 1690 m<sup>3</sup>

 Type: Suction  
Fan mounted: Yes  
Tightness norm: IP 68

**160600 Axial Fan**

 Voltage: 24  
Amp: 4.1

 OD: 310 mm  
Capacity: 1570 m<sup>3</sup>

 Type: Blower  
Tightness norm: IP 68

**160619 Axial Fan**

 Voltage: 24  
Amp: 7.8

 OD: 310 mm  
Capacity: 2440 m<sup>3</sup>

 Type: Blower  
Fan mounted: Yes  
Tightness norm: IP 68

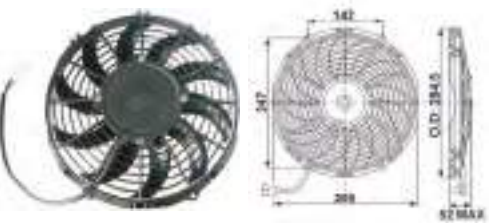
**160714 Axial Fan**

 Voltage: 24  
Amp: 3.7

 OD: 284.5 mm  
Capacity: 1400 m<sup>3</sup>

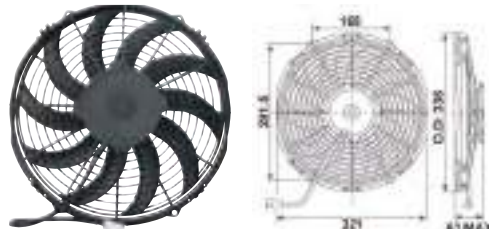
 Type: Blower  
Tightness norm: IP 68

**160737 Axial Fan**

 Voltage: 24  
Amp: 6

 OD: 336 mm  
Capacity: 2240 m<sup>3</sup>

 Type: Blower  
Fan mounted: Yes  
Tightness norm: IP 68

**160777 Axial Fan**

 Voltage: 24  
Amp: 8.4





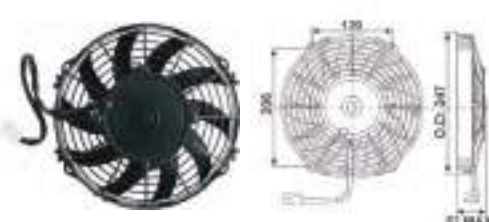





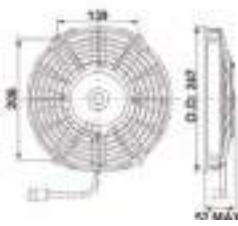

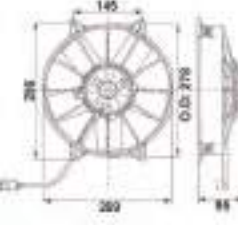
 OD: 414 mm  
Capacity: 3315 m<sup>3</sup>

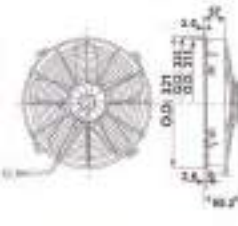
 Type: Suction  
Tightness norm: IP 68

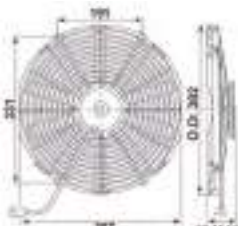
**160799 Axial Fan**

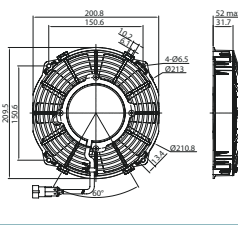
 Voltage: 24  
Amp: 4

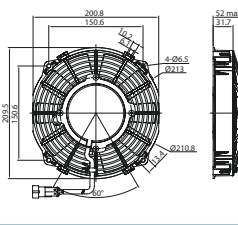
 OD: 347 mm  
Capacity: 1170 m<sup>3</sup>

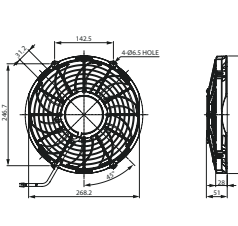
 Type: Suction  
Fan mounted: Yes  
Tightness norm: IP 68

	EL. SPECIFICATIONS	DIMENSIONS	ADDITIONAL SPECIFICATIONS	
<b>160906 Axial Fan</b>			Voltage: 24 Amp: 3.7 OD: 247 mm Capacity: 1070 m <sup>3</sup>	Type: Suction Fan mounted: Yes Tightness norm: IP 68
<b>160907 Axial Fan</b>			Voltage: 24 Amp: 5.7 OD: 278 mm Capacity: 1990 m <sup>3</sup>	Type: Suction Fan mounted: Yes Tightness norm: IP 68
<b>160908 Axial Fan</b>			Voltage: 24 Amp: 7.1 OD: 331 mm Capacity: 2760 m <sup>3</sup>	Type: Blower Fan mounted: Yes Tightness norm: IP 68
<b>160909 Axial Fan</b>			Voltage: 24 Amp: 4.9 OD: 382 mm Capacity: 2170 m <sup>3</sup>	Type: Suction Fan mounted: Yes Tightness norm: IP 68
<b>160998 HC-CARGO Axial Fan</b>			Voltage: 24 Amp: 2.5 OD: 210.8 mm Capacity: 645 m <sup>3</sup>	Type: Suction Tightness norm: IP 68
<b>160999 HC-CARGO Axial Fan</b>			Voltage: 24 Amp: 2.5 OD: 210.8 mm Capacity: 645 m <sup>3</sup>	Type: Blower Tightness norm: IP 68
<b>161001 HC-CARGO Axial Fan</b>			Voltage: 24 Amp: 4 OD: 284.6 mm Capacity: 1437 m <sup>3</sup>	Type: Suction Tightness norm: IP 68

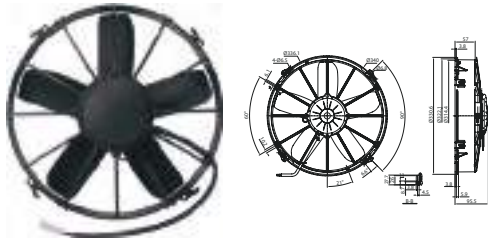
**161004 HC-CARGO Axial Fan**



Voltage: 24  
Amp: 9

OD: 330.6 mm  
Capacity: 2976 m<sup>3</sup>

Type: Suction  
Tightness norm: IP 68

**BLOWERS**

**CENTRIFUGAL TYPE**

**160512 Centrifugal Blower**

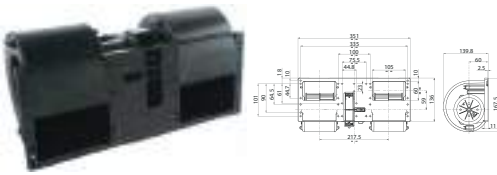

Voltage: 24  
Amp: 15.9

Dim.: 139.8x167.5 mm  
Shaft dia.: 60 mm  
Length: 351 mm  
Capacity: 1160 m<sup>3</sup>  
Pressure: 0 psi  
Speed: 3-speed

No./shafts: 2  
Fan mounted: Yes

**160556 Centrifugal Blower**

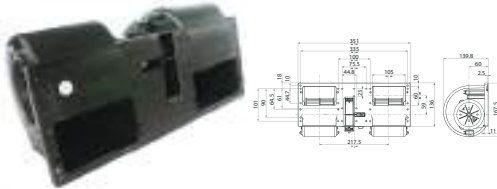

Voltage: 24  
Amp: 8.1

Dim.: 139.8x167.5 mm  
Shaft dia.: 60 mm  
Length: 351 mm  
Capacity: 850 m<sup>3</sup>  
Pressure: 0 psi  
Speed: 3-speed

No./shafts: 2  
Fan mounted: Yes

**160557 Centrifugal Blower**

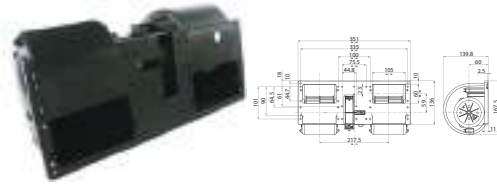

Voltage: 24  
Amp: 12

Dim.: 139.8x167.5 mm  
Shaft dia.: 60 mm  
Length: 351 mm  
Capacity: 1050 m<sup>3</sup>  
Pressure: 0 psi  
Speed: 3-speed

No./shafts: 2  
Fan mounted: Yes

**160594 Centrifugal Blower**

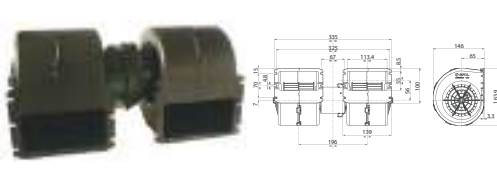

Voltage: 24  
Amp: 11

Dim.: 146x163.9 mm  
Shaft dia.: 65 mm  
Length: 335 mm  
Capacity: 1050 m<sup>3</sup>  
Pressure: 0 psi  
Speed: 3-speed

No./shafts: 2  
Fan mounted: Yes

**160596 Centrifugal Blower**

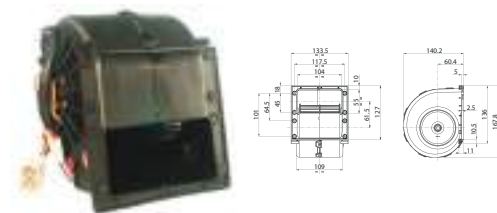

Voltage: 24  
Amp: 11.1

Dim.: 140.2x167.8 mm  
Shaft dia.: 60.4 mm  
Length: 133.5 mm  
Capacity: 530 m<sup>3</sup>  
Pressure: 0 psi  
Speed: 3-speed

No./shafts: 2  
Fan mounted: Yes

**160649 Centrifugal Blower**

Servicing: HC-CARGO 060220



Voltage: 24  
Amp: 8.2

Dim.: 113.1x127.5 mm  
Shaft dia.: 50.1 mm  
Length: 310 mm  
Capacity: 750 m<sup>3</sup>  
Pressure: 0 psi  
Speed: 3-speed

No./shafts: 2  
Fan mounted: Yes





## FUEL GAUGES

### 160872 Fuel Gauge



Voltage: 24

OD: 52 mm

 Mount. type: Hook fastening  
 Colour: Black  
 Measuring unit: l  
 Sender: w/

### 160873 Fuel Gauge

Servicing: HC-CARGO 160701, 160872



Voltage: 12/24

## HOUR METER

### 160702 Hour Meter

*w/o illumination. IP65.*

Voltage: 12-28

OD: 52 mm

 Type: Mechanical  
 Mount. type: Hook fastening  
 Colour: Black  
 Measuring unit: Timer

### 160747 Hour Meter

*w/o illumination.*

Voltage: 10-28

OD: 36.5x25 mm

 Type: Electrical operated  
 Colour: Black  
 Measuring unit: Timer

### 160897 Hour Meter

*Digital.*

Voltage: 10-28

OD: 52 mm

 Type: Electrical operated  
 Mount. type: Hook fastening  
 Colour: Black  
 Measuring unit: Timer  
 Digital: Yes

## OIL PRESSURE GAUGES

### 160779 Oil Pressure Gauge

*Transmitter 1/8" NPTF: HC-CARGO 160787.*

Voltage: 24

OD: 52 mm

 Type: Electrical operated  
 Mount. type: Hook fastening  
 Colour: Black  
 Measuring range: 0-10  
 Sender: w/



## VOLTMETER

### 160696 Voltmeter

White figures.



Voltage: 16-32

OD: 52 mm

Mount. type: Hook fastening  
 Colour: Black  
 Measuring range: 16-32  
 Measuring unit: v

## WATER TEMP. GAUGES

### 160778 Water Temp. Gauge

Transmitter 1/8" NPTF: HC-CARGO 160786.



Voltage: 24

OD: 52 mm

Type: Electrical operated  
 Mount. type: Hook fastening  
 Colour: Black  
 Measuring range: 40-120  
 Measuring unit: v  
 Sender: w/

## POWER MANAGEMENT COMPONENTS

### CHARGERS

#### 160874 Charger



Voltage: 23/24  
 Amp: 12

Weight: 1.660 kg  
 Working temp.:  
 -30°C-+55°C °C

Warning lamp: w/  
 Auto stop: Yes  
 Protection degree: IP 67  
 Approvals: CE

#### 160875 Charger



Voltage: 230/12  
 Amp: 17

Weight: 1.660 kg  
 Working temp.:  
 -30°C-+55°C °C

Warning lamp: w/  
 Auto stop: Yes  
 Protection degree: IP 67  
 Approvals: CE

#### 161026 Charger

Charger cable: HC-CARGO 160990.



Voltage: 230/12  
 Amp: 5  
 Hertz: 50

Dim.: 170x73x48 mm  
 Working temp.:  
 -20°C-+50°C °C

Warning lamp: w/  
 Protection degree: IP 65  
 Approvals: CE

#### 161701 UK Charger

Charger cable: HC-CARGO 160990.



Voltage: 230/12  
 Amp: 5  
 Hertz: 50

Working temp.:  
 -20°C±50°C °C

Warning lamp: w/  
 Protection degree: IP 65  
 Approvals: CE

**ACCESSORIES**
**160990** Charger cable

Servicing: HC-CARGO 161026

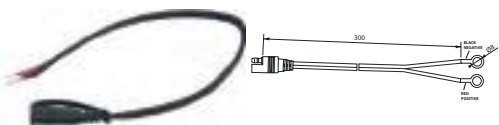

Voltage: 300

 Rolls size: 0.3 m  
Temp. area: 60 °C

 Lead type: Dual  
Cap colour: Black  
Cap material: PVC

**BATTERY ISOLATORS**
**160342** Battery Isolator

Servicing: Boats, autocampers, industrial vehicles

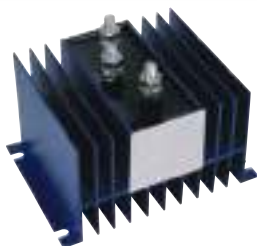
*Eliminates the multi battery drain when 2 or more batteries are in a charging system.*

 Voltage: 6-36  
Current/max Amp:  
70

Dim.: 85x115x95 mm

 No./batteries: 2  
Comp. diode: No

**160343** Battery Isolator

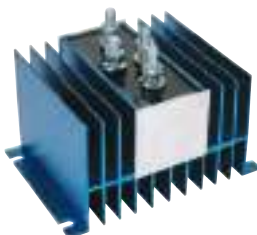
Servicing: Boats, autocampers, industrial vehicles

*Eliminates the multi battery drain when 2 or more batteries are in a charging system. w/ compensationsdiode which allows a higher charging current.*

 Voltage: 6-36  
Current/max Amp:  
70

Dim.: 85x115x95 mm

 No./batteries: 2  
Comp. diode: Yes

**160398** Battery Isolator

Servicing: Boats, autocampers, industrial vehicles

*Eliminates the multi battery drain when 2 or more batteries are in a charging system.*

 Voltage: 6-36  
Current/max Amp:  
120

Dim.: 170x115x95 mm

 No./batteries: 2  
Comp. diode: No

**160399** Battery Isolator

Servicing: Boats, autocampers, industrial vehicles

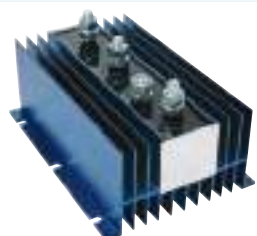
*Eliminates the multi battery drain when 2 or more batteries are in a charging system. w/ compensationsdiode which allows a higher charging current.*

 Voltage: 6-36  
Current/max Amp:  
120

Dim.: 170x115x95 mm

 No./batteries: 2  
Comp. diode: Yes

**160742** Split Charge Relay

Servicing: Boats, autocampers, industrial vehicles

*Microprocessor controlled relay. Allows charging on the auxilliary battery at 27 V charging voltage.*

 Voltage: 24  
Current/max Amp:  
100

Dim.: 120x80x70 mm

 No./batteries: 2  
Comp. diode: No

**160877** Split Charge Relay

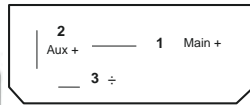

Voltage: 24  
Current/max Amp: 50

Dim.: 60x34x70 mm

No./batteries: 2  
Comp. diode: No

**161060** Split Charge Relay

25.6V-26.6V

**NEW PRODUCT**  
[www.hc-cargo.com](http://www.hc-cargo.com)

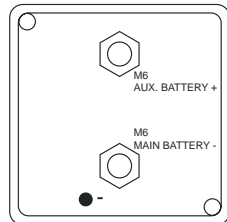

Voltage: 24  
Current/max Amp: 140

Dim.: 67x67x50 mm

No./batteries: 2  
Comp. diode: No

**POWER GUARD**

**161014** Power Guard



Voltage/in: 9-32  
Alarm/Voltage: Yes  
Shut down/Voltage: Yes  
Shut down/12 V: 11.5 V  
Shut down/24 V: 23 V  
Amp/max/cont.: 10

Dim.: 155x30x15 mm  
Weight: 0.045 kg  
Regulation: Yes

Connection: Connection  
Over heating: Yes  
Overloading: Yes  
Short circuit: Yes

**161015** Power Guard



Voltage/in: 9-32  
Alarm/Voltage: Yes  
Shut down/Voltage: Yes  
Shut down/12 V: 11.5 V  
Shut down/24 V: 23 V  
Amp/max/cont.: 20

Dim.: 155x30x15 mm  
Weight: 0.045 kg  
Regulation: Yes

Connection: Connection  
Over heating: Yes  
Overloading: Yes  
Short circuit: Yes

**161016** Power Guard

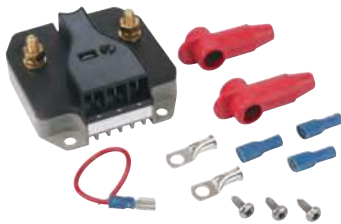

Voltage/in: 9-32  
Alarm/Voltage: Yes  
Shut down/Voltage: Yes  
Shut down/12 V: 11.5 V  
Shut down/24 V: 23 V  
Amp/max/cont.: 40

Dim.: 76x78x33 mm  
Weight: 0.155 kg  
Regulation: Yes

Connection: M6  
Over heating: Yes  
Overloading: Yes  
Short circuit: Yes

**161017** Power Guard

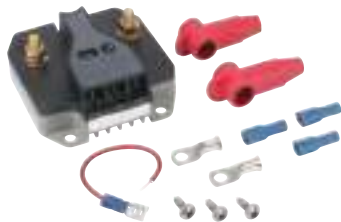

Voltage/in: 9-32  
Alarm/Voltage: Yes  
Shut down/Voltage: Yes  
Shut down/12 V: 11.5 V  
Shut down/24 V: 23 V  
Amp/max/cont.: 60

Dim.: 76x78x33 mm  
Weight: 0.155 kg  
Regulation: Yes

Connection: M6  
Over heating: Yes  
Overloading: Yes  
Short circuit: Yes

**161018** Power Guard

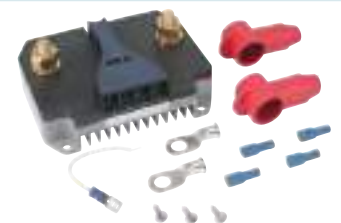

Voltage/in: 9-32  
Alarm/Voltage: Yes  
Shut down/Voltage: Yes  
Shut down/12 V: 11.5 V  
Shut down/24 V: 23 V  
Amp/max/cont.: 100

Dim.: 124x97x51 mm  
Weight: 0.530 kg  
Regulation: Yes

Connection: M10  
Over heating: Yes  
Overloading: Yes  
Short circuit: Yes

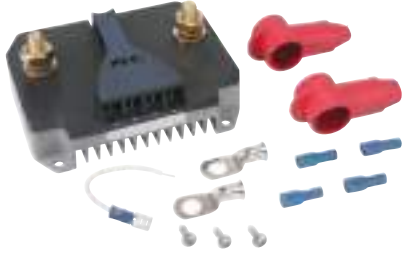
**161019 Power Guard**

Voltage/in: 9-32  
 Alarm/Voltage: Yes  
 Shut down/Voltage: Yes  
 Shut down/12 V: 11.5 V  
 Shut down/24 V: 23 V  
 Amp/max/cont.: 200

Dim.: 124x97x51 mm  
 Weight: 0.530 kg  
 Regulation: Yes

Connection: M10  
 Over heating: Yes  
 Overloading: Yes  
 Short circuit: Yes

**RELAY BOXES**
**160167 Relay Box**

Servicing: For 12 V trailer pulled by a 24 V vehicle

Switches the voltage from 24 V to 12 V by 5 relays. Run at 24 V and leading 12 V from one of the batteries or converter to the lamps of the trailer. For continuous use it has to be connected via a converter. For internal mounting.



Voltage: 12/24  
 Amp: 10  
 Watt: 250

Dim.: 100x100x58 mm

No./poles: 7  
 Relay switch: Yes

**160502 Trailer Connecting Unit**

Servicing: For 12 V trailer pulled by a 24 V vehicle

Mounted w/o use of converter.



Voltage: 12/24

Dim.: 110x103x43 mm

C2 control lamp: w/  
 No./poles: 7  
 Relay switch: No  
 Transistor switch: Yes  
 Waterproof: Yes  
 IP rating: IP 65

**PUMPS & PUMP PARTS**
**ELECTRICAL BILGE PUMPS**
**ACCESSORIES**
**070160 Automatic Float Switch**

Made of corrosion resistant materials.



Voltage: 12/24  
 Amp: 10

Dim.: 113x83x62 mm  
 Height/closed: 22  
 Height/open: 57

Type: Gear  
 Floating switch: w/

**ELECTRICAL FLUID PUMPS**
**070148 Fluid Pump**

Servicing: Main application: transfer of diesel fuel, water antifreeze etc.

Model UP/3. self-priming 1.5 m. Electric pump w/ bronze gears for transfer of various liquids, complete w/ inline filter. Pump body made of brass w/ stainless steel shaft and a rubber lip seal. 3/8" BSP w/ brass connection for I.D. 14 mm inner tubing.

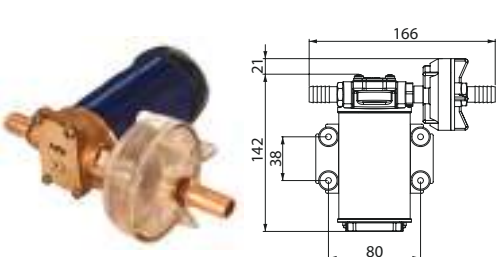

Voltage: 24  
 Amp: 5

Dim.: 163x166x95 mm  
 Hose connection: 14 mm  
 Weight: 1.4 kg  
 Capacity: 14 l/min  
 Pressure: 2 bar  
 Pressure: 29 psi

Pump housing: Brass  
 Pump shaft: Stainless steel  
 Pinion: Brass  
 Filter: w/

**070150** Fluid Pump

Servicing: Main application: transfer of diesel fuel, water antifreeze etc.

Self-priming electric pump w/ helical bronze gears, complete with in-line filter. Nickel plated brass body w/ stainless steel shaft. Ports: 1/2" BSP w/ brass connection for Ø 16 mm inner tubing.

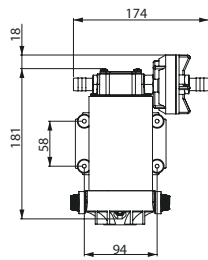

Voltage: 24  
Amp: 7.5

Dim.: 199x174x108 mm  
Hose connection: 16 mm  
Weight: 3.1 kg  
Capacity: 26 l/min  
Pressure: 2 bar  
Pressure: 29 psi

Type: Gear  
Pump housing: Brass  
Pump shaft: Stainless steel  
Pinion: Brass  
Filter: w/

**070173** Fluid Pump

Model UP6 w/ oil. Self-priming 1.5 m. Electrical gear pump particularly suitable for the transfer of lubricating oils or viscous liquids. Professional model complete w/ two brass connections for 14 mm inner tube and one additional quick-fit for 8 mm external tubing. The pump can be used for extracting lubricating oil out of oil sumps of engines.

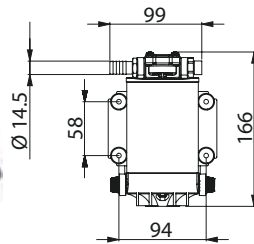

Voltage: 24  
Amp: 7.5

Dim.: 166x117x94 mm  
Hose connection: 14 mm  
Weight: 2.5 kg  
Capacity: 8 l/min  
Pressure: 2 bar  
Pressure: 29 psi

Type: Fluid, Gear  
Pump housing: Brass  
Pump shaft: Stainless steel  
Impeller: Rubber  
Pinion: Bronze

**070209** Electrical Fluid Pump HD

Model UP12. Self-priming 4 m.

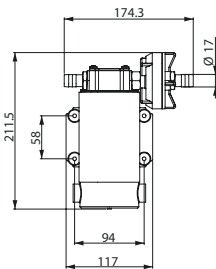

Voltage: 24  
Amp: 15

Dim.: 212x174x109 mm  
Hose connection: 16 mm  
Weight: 4.3 kg  
Capacity: 40 l/min  
Pressure: 2.5 bar  
Pressure: 36 psi

Type: Fluid, Gear  
Pump housing: Brass  
Pump shaft: Stainless steel  
Pinion: Bronze  
Filter: w/  
Non return valve: Yes

**ELECTRICAL FUEL PUMPS**

**DIESEL PUMP KITS**

**070175** Diesel Transfer/Filter Kit

2.5 m suction hose w/ filter. 2.5 m pressure hose w/ gun. 2 m cable w/ alligator clips. Switch on the pump. Bypass valve on the pump ensure against overloading. Not for gasoline.



Voltage: 24  
Amp: 7.5

Dim.: 210x161x120 mm  
Hose connection: 25 mm  
Capacity: 45.1 l/min  
Pressure: 1.2 bar  
Pressure: 17.4 psi

Type: Fluid  
Filter: w/

**INTERRUPTER PUMPS**

**070004** Fuel Pump

Incl. 2 pcs. 6 mm hose nipples. 8 mm: HC-CARGO 080955. 8 mm angle: HC-CARGO 070181.



Voltage: 24

Capacity: 113.5 l/h  
Pressure: 4-5 psi

Type: Universal



## PRESSURE PUMPS

### 070107 Fuel Pump

Hose nipple 8 mm. Suction 1.5 mtr. Connectors can be rotated. Fitting instruction included.



Voltage: 24

Capacity: 130 l/h  
Pressure: 0.35 bar

Fuel: Gasoline, diesel, ethanol, methanol  
Type: Universal

## SOLID STATE PUMPS

### 070056 Fuel Pump

Servicing: Caterpillar, IH/Case



Voltage: 24

Capacity: 121 l/h  
Pressure: 0.3-0.45 kg  
Pressure: 4.5-6 psi

Type: Universal

## ELECTRICAL WATER PUMPS

### 070145 Water Pump

Model UP1-N. Self priming (1.5 m) electric water pump w/ self-lubricating flexible impeller for prolonged service life and better performance. Pump body made of brass w/ stainless steel shaft and a rubber lip seal. 1/2" BSP inner thread and ID 25 mm bore hose connections. Main application: as a bilge pump.

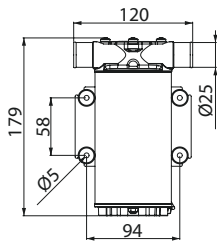

Voltage: 24  
Amp: 15

Dim.: 176x120x94 mm  
Hose connection: 25 mm  
Capacity: 35 l/min  
Pressure: 0.8 bar  
Pressure: 11.6 psi

Type: Water, Impeller  
Pump housing: Brass  
Pump shaft: Stainless steel  
Impeller: Rubber  
Non return valve: Yes  
ISO norm: 8849/8846

### 070172 Water Pump

Model UP4/A. Self priming electric gear pump equipped w/ pressure switch, non-return valve to be used as automatic pump for water pressure system on boats, mobile homes etc. Bronze gears and rubber lip seal.

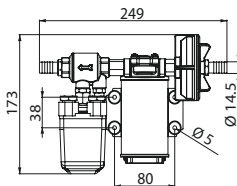

Voltage: 24  
Amp: 5

Dim.: 163x249x118 mm  
Hose connection: 14 mm  
Weight: 2.2 kg  
Capacity: 14 l/min  
Pressure: 2 bar  
Pressure: 29 psi

Type: Water, Gear  
Pump housing: Brass  
Pump shaft: Stainless steel  
Pinion: PTFE  
Filter: w/  
Non return valve: Yes

## SOLENOID SHUTDOWN

### 080178 Solenoid Stop



Voltage: 24  
Voltage 2: 24

Filter: w/o  
Insulated return: No

### 080208 Solenoid Stop



Voltage: 24  
Voltage 2: 24

Filter: w/o  
Insulated return: No

**080210 Solenoid Stop**

 Voltage: 24  
 Voltage 2: 24

 Elect. connection: Plug  
 Filter: w/o  
 Insulated return: Yes

**080211 Solenoid Stop**

 Voltage: 24  
 Voltage 2: 24

 Filter: w/o  
 Insulated return: No

**080926 Solenoid Stop**

 Voltage: 24  
 Voltage 2: 24

Filter: w/o

**080996 Solenoid Stop**

 Voltage: 24  
 Voltage 2: 24

 Elect. connection: Multiplug  
 Filter: w/o  
 Insulated return: Yes

**081002 Solenoid Stop**

 Voltage: 24  
 Voltage 2: 24

 Elect. connection: Cable  
 Function: Push  
 Filter: w/o  
 Insulated return: Yes

## INTERNALLY SWITCHED

**090161 Shutdown Solenoid**

*This solenoid can switch off the pull coil, and no external 'control' is necessary.*

 Voltage: 24  
 Amp/hold: 0.25  
 Amp/pull: 17

 Thread size: 6  
 Thread type: mm  
 Pull rating: 40N at  
 25.40 mm  
 Return spring: 17N  
 Hold rating: 89N

 Plunger: Internal  
 Elect. connection: Plug  
 Function: Pull  
 Mount. type: Flange/bracket  
 Switch: Internal

**090169 Shutdown Solenoid**

*This solenoid can switch off the pull coil, and no external 'control' is necessary.*

 Voltage: 24  
 Amp/hold: 0.3  
 Amp/pull: 23

 Thread size: 6  
 Thread type: mm  
 Pull rating: 75N at  
 25.40 mm  
 Return spring: 35N  
 Hold rating: 178N

 Plunger: External  
 Elect. connection: Plug  
 Function: Pull  
 Mount. type: Flange/bracket  
 Switch: Internal  
 Aux terminal: Yes

**090297 Shutdown Solenoid**

*This solenoid can switch off the pull coil, and no external 'control' is necessary.*



Voltage: 24  
Amp/hold: 1.1  
Amp/pull: 46

Thread size: 6  
Thread type: mm  
Pull rating: 107N at  
25.40 mm  
Return spring: 7-11N  
Hold rating: 169N

Plunger: External  
Switch: Internal  
Aux terminal: No

**090317 Shutdown Solenoid**

*This solenoid can switch off the pull coil, and no external 'control' is necessary.*



Voltage: 24  
Amp/hold: 0.3  
Amp/pull: 20

Pull rating: 98N at  
32.00 mm  
Return spring: 45N  
Hold rating: 245N

Plunger: Internal  
Switch: Internal  
Coil commander: w/

**090402 Shutdown Solenoid**

Servicing: Kubota super 5 series

*This solenoid can switch off the pull coil, and no external 'control' is necessary.*



Voltage: 24  
Amp/hold: 0.59  
Amp/pull: 19.6

Thread size: 0.154  
Thread type: Inches

Plunger: Internal  
Switch: Internal

## EXTERNALLY SWITCHED

**090110 Shutdown Solenoid**

*This solenoid can't switch off by itself, it will have to be controlled externally.*



Voltage: 24  
Amp/hold: 0.25  
Amp/pull: 17

Thread size: 6  
Thread type: mm  
Pull rating: 40N at  
25.40 mm  
Return spring: 9N  
Hold rating: 89N

Plunger: External  
Elect. connection: Plug  
Function: Pull  
Mount. type: Flange/bracket  
Switch: External

**090113 Shutdown Solenoid**

*This solenoid can't switch off by itself, it will have to be controlled externally.*



Voltage: 24  
Amp/hold: 0.3  
Amp/pull: 23

Thread size: 6  
Thread type: mm  
Pull rating: 75N at  
25.40 mm  
Return spring: 35N  
Hold rating: 178N

Plunger: External  
Elect. connection: Plug  
Function: Pull  
Mount. type: Flange/bracket  
Switch: External

**090200 Shutdown Solenoid**

*This solenoid can't switch off by itself, it will have to be controlled externally.*



Voltage: 24  
Amp/hold: 4  
Amp/pull: 18

Thread size: 6  
Thread type: mm  
Pull rating: 67N at  
25.40 mm  
Return spring: 17N  
Hold rating: 178N

Plunger: External  
Elect. connection: Cable  
Function: Pull/Push  
Switch: External

**090226** Shutdown Solenoid

*This solenoid can't switch off by itself, it will have to be controlled externally.*



Voltage: 24  
Voltage 2: 24  
Amp/hold: 0.5  
Amp/pull: 25

Thread size: 6  
Thread type: mm  
Pull rating: 111N at 25.40 mm  
Return spring: 7N  
Hold rating: 182N

Plunger: External  
Elect. connection: Multiplug  
Function: Pull  
Switch: External

**090267** Shutdown Solenoid

Servicing: Volvo wheel loader

*Syncro start/Woodward.*



Voltage: 24  
Amp/hold: 0.86  
Amp/pull: 39

Pull rating: 129N at 25.4 mm  
Hold rating: 182N

Plunger: Cable  
Elect. connection: Multiplug  
Function: Pull  
Switch: External

**090281** Shutdown Solenoid

Servicing: Volvo

*This solenoid can't switch off by itself, it will have to be controlled externally.*



Voltage: 24  
Amp/hold: 0.5  
Amp/pull: 25

Thread size: 6  
Thread type: mm  
Pull rating: 89N at 25.40 mm  
Hold rating: 236N

Plunger: External  
Elect. connection: Multiplug  
Function: Pull/Push  
Mount. type: Bracket  
Switch: External

**090371** Shutdown Solenoid

Servicing: Kubota D722, Z482

*This solenoid can't switch off by itself, it will have to be controlled externally.*



Voltage: 24  
Amp/hold: 0.5  
Amp/pull: 25

Thread size: 1/4 - 28 UNF-2A  
Pull rating: 111N  
Hold rating: 182N

Plunger: External  
Elect. connection: Cable  
Switch: External

**090431** Shutdown Solenoid

*This solenoid can't switch off by itself, it will have to be controlled externally.*



Voltage: 24  
Voltage 2: 24  
Amp/hold: 0.57  
Amp/pull: 30

Thread size: 5/16" Thread type: Inches  
Pull rating: 165N  
Return spring: 80-115N  
Hold rating: 391N

Plunger: External  
Function: Pull  
Mount. type: Flange/bracket  
Switch: External  
Insulated return: Yes

**INTERNALLY SWITCHED**

**KITS**

**090101** Solenoid Shutdown Kit

*This solenoid can switch off the pull coil, and no external 'control' is necessary.*



Voltage: 24  
Amp/hold: 0.5  
Amp/pull: 25

Pull rating: 89N at 25.40 mm  
Mount. side: Left  
Hold rating: 178N

Elect. connection: Plug  
Function: Pull  
Switch: Internal

**090102 Solenoid Shutdown Kit**

*This solenoid can switch off the pull coil, and no external 'control' is necessary.*



Voltage: 24  
Amp/hold: 0.5  
Amp/pull: 25

Pull rating: 89N at  
25.40 mm  
Hold rating: 178N

Elect. connection: Plug  
Function: Pull  
Switch: Internal

**EXTERNALLY SWITCHED**
**KITS**
**090099 Solenoid Shutdown Kit**

*This solenoid can't switch off by itself, it will have to be controlled externally.*



Voltage: 24  
Amp/hold: 0.5  
Amp/pull: 25

Pull rating: 89N at  
25.40 mm  
Mount. side: Left  
Hold rating: 178N

Elect. connection: Cable  
Function: Pull  
Mount. type: Flange/bracket  
Switch: External

**090100 Solenoid Shutdown Kit**

*This solenoid can't switch off by itself, it will have to be controlled externally.*



Voltage: 24  
Amp/hold: 0.5  
Amp/pull: 25

Pull rating: 89N at  
25.40 mm  
Mount. side: Right  
Hold rating: 178N

Elect. connection: Cable  
Function: Pull  
Mount. type: Flange/bracket  
Switch: External

**090105 Solenoid Shutdown Kit**

Servicing: Nippodenso, Zexel

*This solenoid can't switch off by itself, it will have to be controlled externally.*



Voltage: 24  
Amp/hold: 0.63  
Amp/pull: 29

Pull rating: 89N at  
25.40 mm  
Mount. side: Left  
Hold rating: 178N

Elect. connection: Cable  
Function: Pull  
Switch: External

**090106 Solenoid Shutdown Kit**

Servicing: Nippodenso, Zexel

*This solenoid can't switch off by itself, it will have to be controlled externally.*



Voltage: 24  
Amp/hold: 0.63  
Amp/pull: 29

Pull rating: 89N at  
25.40 mm  
Mount. side: Right  
Hold rating: 178N

Elect. connection: Cable  
Function: Pull  
Switch: External

**090108 Solenoid Shutdown Kit**

*This solenoid can't switch off by itself, it will have to be controlled externally.*



Voltage: 24  
Amp/hold: 0.63  
Amp/pull: 29

Pull rating: 89N at  
25.40 mm  
Mount. side: Left  
Hold rating: 178N

Elect. connection: Multiplug  
Function: Pull  
Switch: External



**PULL COIL TIMER MODULES**
**090116 Pull Coil Timer**

Voltage: 24

No./wires: 3

**SWITCHES & SENSORS - ENGINE MANAGEMENT**
**SWITCHES**
**BATTERY SWITCHES**
**180028 Battery Main Switch**

Spare key: HC-CARGO 180143, 180619, 181270. Pole: dia. 10 mm.

 Voltage: 24  
 Amp/5 sec.: 500  
 Amp/cont.: 100

 Dist. mount. holes:  
 38 mm

 Type: Battery  
 Material: Plastic  
 No./mounting holes: 2  
 Key: w/  
 Protection degree: IP 65

**180029 Key**

Servicing: HC-CARGO 180028, 180203, 180216, 180229, 180313, 180596



Shaft length: 11 mm

No./pins: 2

**180087 Battery Main Switch**

Spare key: HC-CARGO 180202.

 Voltage: 24  
 Amp/5 sec.: 2500  
 Amp/cont.: 250

 Dist. mount. holes:  
 100 mm

 Type: Battery  
 Material: Metal  
 No./mounting holes: 2  
 Key: w/  
 Protection degree: IP 66

**180143 Key**

Servicing: HC-CARGO 180028, 180216, 180313



Shaft length: 9 mm

**180202 Key**

Servicing: HC-CARGO 180087



**180203 Battery Main Switch**

Spare key: HC-CARGO 180029, 180619.

 Voltage: 24  
 Amp/5 sec.: 2500  
 Amp/cont.: 250

 Dist. mount. holes:  
 100 mm

 Type: Battery  
 Material: Plastic  
 No./mounting holes: 2  
 No./poles: 2  
 Key: w/  
 Protection degree: IP 66

**180211 Battery Main Switch**

Spare key: HC-CARGO 180288, 180333. Rubber boot: HC-CARGO 180375.

 Voltage: 24  
 Amp/5 sec.: 2500  
 Amp/cont.: 250

 Dist. mount. holes:  
 100 mm

 Type: Battery  
 Material: Metal  
 No./mounting holes: 2  
 Key: w/  
 Protection degree: IP 65

**180216 Battery Main Switch**

Spare key: HC-CARGO 180143, 180619, 181270. Rubber protection cap: HC-CARGO 180374.

 Voltage: 24  
 Amp/5 sec.: 500  
 Amp/cont.: 100

 Dist. mount. holes:  
 39.5 mm

 Type: Battery  
 Material: Plastic  
 No./mounting holes: 2  
 No./poles: M8  
 Key: w/  
 Protection degree: IP 40

**180229 Battery Main Switch**

Spare key: HC-CARGO 180029, 180619, 181270. On/Off under load.

 Voltage: 24  
 Amp/5 sec.: 2500  
 Amp/cont.: 250

 Dist. mount. holes:  
 100 mm

 Type: Battery  
 Material: Plastic  
 No./mounting holes: 2  
 Key: w/  
 Protection degree: IP 66

**180232 Battery Switch**

Servicing: Industrial vehicles, buses, tractors, lift trucks and boats

 Voltage: 12  
 Amp/5 sec.: 2500  
 Amp/cont.: 250

 Type: Electromagnetic  
 Switch: Negative  
 Protection degree: IP 65

**180233 Battery Switch**

Industrial vehicles, buses, tractors, lift trucks and boats

 Voltage: 24  
 Amp/5 sec.: 2500  
 Amp/cont.: 250

 Type: Electromagnetic  
 Switch: Negative  
 Protection degree: IP 65







**180271 Battery Main Switch**

Rubber boot: HC-CARGO 180375. Working temp. -30°C/+65°C.

 Voltage: 12/24  
 Amp/5 sec.: 1000  
 Amp/cont.: 300

 Dist. mount. holes:  
 45 mm

 Type: Battery  
 Material: Plastic  
 Explosion proof: Yes  
 No./mounting holes: 2  
 No./poles: M10  
 Key: w/  
 Waterproof: Yes  
 Protection degree: IP 65  
 Approval: SAE J1171

EL. SPECIFICATIONS		DIMENSIONS	ADDITIONAL SPECIFICATIONS
<b>180272 Battery Main Switch</b> Servicing: Marine			
<i>Spare key: HC-CARGO 180333. Rubber boot: HC-CARGO 180375.</i>			
	Voltage: 24 Amp/5 sec.: 1000 Amp/cont.: 150	Dist. mount. holes: 45 mm	Type: Battery Material: Metal Explosion proof: Yes No./mounting holes: 2 Key: w/ Waterproof: Yes Protection degree: IP 68
<b>180274 Battery Main Switch</b>			
<i>Rubber boot: HC-CARGO 180375 . For alternator w/ separate regulator.</i>			
	Voltage: 24 Amp/5 sec.: 2500 Amp/cont.: 250	Dist. mount. holes: 65 mm	Type: Battery Material: Metal Explosion proof: Yes No./mounting holes: 2 Key: w/ Waterproof: Yes Protection degree: IP 67
<b>180275 Battery Main Switch</b>			
<i>Rubber boot: HC-CARGO 180375. For alternator w/ intergral regulator. w/ D+ contact.</i>			
	Voltage: 24 Amp/5 sec.: 2500 Amp/cont.: 250	Dist. mount. holes: 65 mm	Type: Battery Material: Metal Explosion proof: Yes No./mounting holes: 2 Key: w/ Waterproof: Yes Protection degree: IP 67
<b>180276 Battery Main Switch</b>			
<i>Rubber boot: HC-CARGO 180375. For alternator w/ intergral regulator. w/ D+ contact.</i>			
	Voltage: 24 Amp/5 sec.: 2500 Amp/cont.: 250	Dist. mount. holes: 110 mm	Type: Battery Material: Metal Explosion proof 1: Yes Explosion proof 2: Yes No./mounting holes: 2 No./poles: 2 Key: w/ Waterproof: Yes Protection degree: IP 67 Approval: ADR
<b>180277 Battery Main Switch</b>			
<i>Rubber boot: HC-CARGO 180375 . For alternator w/ separate regulator.</i>			
	Voltage: 24 Amp/5 sec.: 2500 Amp/cont.: 250	Dist. mount. holes: 110 mm	Type: Battery Material: Metal Explosion proof 1: Yes Explosion proof 2: Yes No./mounting holes: 2 No./poles: 2 Key: w/ Waterproof: Yes Protection degree: IP 67
<b>180278 Battery Main Switch</b>			
<i>Spare key: HC-CARGO 181477. Rubber boot: HC-CARGO 180375.</i>			
	Voltage: 24 Amp/5 sec.: 3000 Amp/cont.: 300	Dist. mount. holes: 100 mm	Type: Battery Material: Metal Explosion proof: Yes No./mounting holes: 2 Key: w/ Waterproof: Yes Protection degree: IP 68
<b>180288 Key</b> Servicing: HC-CARGO 180211			
			No./pins: 2

**180289 Battery Main Switch**
*Rubber boot: HC-CARGO 180375.*

 Voltage: 24  
 Amp/5 sec.: 2500  
 Amp/cont.: 250

 Dist. mount. holes:  
 M30 mm

 Type: Battery  
 Material: Metal  
 No./mounting holes: 2  
 Key: w/  
 Protection degree: IP 65

**180290 Battery Switch Relay**
*For serial and parallel connction of two 12 V batteries in 12 V systems w/ 24 V starter.*

 Voltage: 12/24  
 Amp/5 sec.: 1500  
 (1 sec)  
 Amp/cont.: 75

**180313 Battery Main Switch**
*Spare key: HC-CARGO 180143, 181270. Rubber protection cap: HC-CARGO 180374.*

 Voltage: 24  
 Amp/5 sec.: 500  
 Amp/cont.: 100

 Dist. mount. holes:  
 45 mm

 Type: Battery  
 No./mounting holes: 2  
 Key: w/o  
 Protection degree: IP 40

**180326 Battery Main Switch**
*Rubber boot: HC-CARGO 180375. w/ rotation/press handle.*

 Voltage: 24  
 Amp/5 sec.: 2500  
 Amp/cont.: 250

 Dist. mount. holes:  
 100 mm

 Type: Battery  
 No./mounting holes: 2  
 Protection degree: IP 65

**180333 Key**

Servicing: HC-CARGO 180211, 181238



No./pins: 1

**180338 Battery Main Switch**
*For alternator w/ separate regulator. w/ secondary circuit 24 V. Rubber boot: HC-CARGO 180375.*

 Voltage: 24  
 Amp/5 sec.: 2500  
 Amp/cont.: 20

 Dist. mount. holes:  
 65 mm







 Type: Battery  
 Material: Plastic  
 Explosion proof: Yes  
 No./mounting holes: 2  
 Key: w/  
 Sec. circuit: w/  
 Waterproof: Yes  
 Protection degree: IP 67

**180374 Terminal Boot**

Servicing: HC-CARGO 180216, 180313

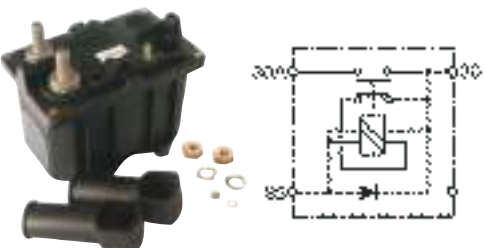

Material: Rubber

<b>180375 Terminal Boot set</b> Servicing: HC-CARGO 180211, 180271, 180272, 180274, 180275, 180276, 180277, 180278, 180289, 180326, 180338, 180238 Supplied in kit of 2 pcs.				Material: Rubber
				
<b>180556 Battery Switch</b>		Voltage: 24 Amp/5 sec.: 2500 Amp/cont.: 250		Type: Electromagnetic Switch: Positive/Negative
				
<b>180596 Battery Main Switch</b> Spare key: HC-CARGO 180029, 180619.		Voltage: 24 Amp/5 sec.: 500 Amp/cont.: 100	Dist. mount. holes: 38 mm	Type: Battery Material: Plastic No./mounting holes: 2 Key: w/ Resistor: 3 Ohm, 11 W Sec. circuit: w/ Protection degree: IP 43
				
<b>180602 Battery Switch</b>		Voltage: 12 Amp/5 sec.: 2500 Amp/cont.: 250		Type: Electromagnetic Switch: Positive
				
<b>180603 Battery Switch</b>		Voltage: 24 Amp/5 sec.: 2500 Amp/cont.: 200		Type: Electromagnetic Switch: Positive
				
<b>180604 Battery Switch</b> w/ separate power supply.		Voltage: 12 Amp/5 sec.: 2500 Amp/cont.: 250		Type: Electromagnetic Switch: Positive/Negative
				



**180605 Battery Switch**
*w/ separate power supply.*

 Voltage: 24  
 Amp/5 sec.: 2500  
 Amp/cont.: 200

 Type: Electromagnetic  
 Switch: Positive/Negative

**180614 Battery Main Switch**
*Spare key: HC-CARGO 181578.*

 Voltage: 24  
 Amp/5 sec.: 1000  
 Amp/cont.: 75

 Dist. mount. holes:  
 38 mm

 Type: Battery  
 Material: Metal  
 No./mounting holes: 2  
 Key: w/  
 Protection degree: IP 41

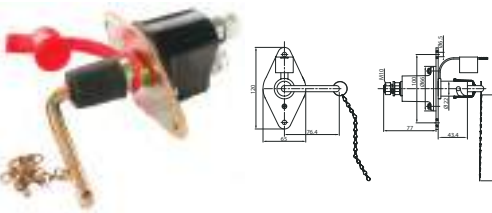
**181238 Battery Main Switch**
*Spare key: HC-CARGO 180333. Rubber boot: HC-CARGO 180375.*

 Voltage: 24  
 Amp/5 sec.: 2500  
 Amp/cont.: 250

 Dist. mount. holes:  
 100 mm

 Type: Battery  
 Material: Metal  
 No./mounting holes: 2  
 Key: w/  
 Waterproof: Yes  
 Protection degree: IP 66

**181475 Battery Main Switch**
*Spare key: HC-CARGO 180288, w/o chain and rubber cap. Rubber boot: HC-CARGO 180375.*

 Voltage: 24  
 Amp/5 sec.: 2500  
 Amp/cont.: 250

 Dist. mount. holes:  
 100 mm

 Material: Metal  
 No./mounting holes: 2  
 Key: w/  
 Protection degree: IP 65

**181476 Battery Switch**
*Plug: HC-CARGO 181545.*





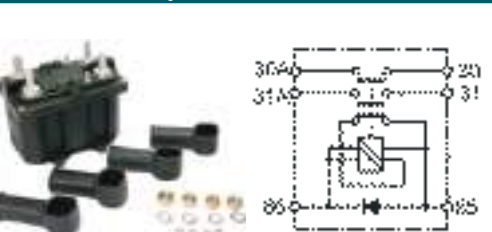

 Voltage: 24  
 Amp/5 sec.: 2500  
 Amp/cont.: 250

 Type: Electromagnetic  
 Explosion proof 1: Yes  
 Explosion proof 2: Yes  
 Switch: Positive/Negative  
 No./mounting holes: 4  
 No./poles: 4  
 Approval: Ex

**181562 Battery Switch**

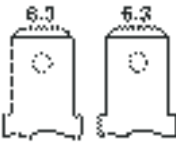
 Voltage: 12  
 Amp/5 sec.: 2500  
 Amp/cont.: 250

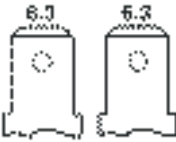
 Switch: Positive/Negative  
 Comp. diode: Yes



<b>160289</b> Washer Pump  		Servicing: Peugeot, Citroen, Renault Voltage: 24      Capacity: 1500 ml/min		Pump type: Single
<b>160360</b> Washer Pump  		Servicing: Rover Group, Honda Voltage: 12      Capacity: 1400 ml/min		Type: Universal Pump type: Single
<b>160507</b> Washer Pump  		Voltage: 24      Capacity: 1500 ml/min		Type: Universal Pump type: Single
<b>160630</b> Washer Pump HC-CARGO 160273.  		Voltage: 24      Capacity: 1800 ml/min		Type: Universal Pump type: Single

## TANKS

<b>160188</b> Washer Tank Washer pump: HC-CARGO 160360. 		Voltage: 24      Can capacity: 3 l		Type: Can Motor: w/
<b>160967</b> Washer Tank Doga ref. 232.2001.30.00. 		Voltage: 24      Can capacity: 2.1 l		Type: Can Can: w/ pump

**KITS**
**160273** Washer Kit

Pump: HC-CARGO 160630.



Voltage: 24

Dim.: 190x130x100 mm

Type: Complete kit

**WIPER BLADES**
**FOR TRUCKS**
**161013** Wiper Blade

Servicing: Trucks

 Length: 900 mm  
Length: 36"

Reference: P90

**WIPER ARMS**
**160256** Wiper Arm

Wiper motor: HC-CARGO 160258, 160290, 160291, 160357, 160408.

 Length: 450 mm  
Dist./wiper arms:  
57 mm  
Mount./wiper shaft: M6  
cone + M8 shaft mm

 Type: Parallel  
Length/adjustable: No

**160257** Wiper Arm

Usable w/ HC-CARGO 160258, 160290, 160291, 160357, 160408.

 Length: 400 mm  
Dist./wiper arms:  
57 mm  
Mount./wiper shaft: M6  
cone + M8 shaft mm

 Type: Parallel  
Length/adjustable: No

**160339** Wiper Arm

Wiper motor: HC-CARGO 160292, 106293.

 Length: 400 mm  
Dist./wiper arms:  
57 mm  
Mount./wiper shaft:  
6+M8 shaft mm

 Type: Parallel  
Length/adjustable: No

**160358** Wiper Arm

Wiper motor: HC-CARGO 160258, 160290, 160291, 160357, 160408.

 Length: 500 mm  
Dist./wiper arms:  
57 mm  
Mount./wiper shaft: M6  
cone + M8 shaft mm

 Type: Parallel  
Length/adjustable: No

**160359 Wiper Arm**

Wiper motor: HC-CARGO 160258, 160290, 160291, 160357, 160408.



Length: 550 mm  
 Dist./wiper arms: 57 mm  
 Mount./wiper shaft: M6 cone + M8 shaft mm

Type: Parallel  
 Length/adjustable: No

**160484 Wiper Arm**

Usable w/ HC-CARGO 160258, 160480.



Length: 340-420 mm  
 Dist./wiper arms: 57 mm  
 Mount./wiper blade: 9x2.5 mm hook  
 Mount./wiper shaft: M8 cone + M8 shaft mm

Type: Parallel  
 Length/adjustable: Yes

**160485 Wiper Arm**

Length: 430-500 mm  
 Dist./wiper arms: 57 mm  
 Mount./wiper blade: 9x2.5 mm hook  
 Mount./wiper shaft: M8 cone + M8 shaft mm

Type: Parallel  
 Length/adjustable: Yes

**160571 Wiper Arm**

Length: 680 mm  
 Dist./wiper arms: 60 mm  
 Mount./wiper shaft: 2x8 cone mm

Type: Parallel  
 Length/adjustable: No

**WIPER MOTORS**
**160396 Wiper Motor**

Servicing: Nissan Patrol 86-93

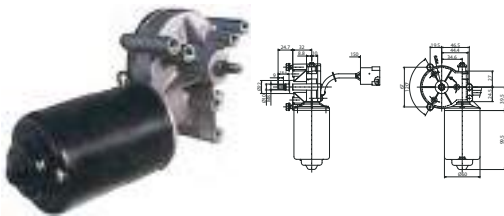

Voltage: 24

Type: OE  
 Position: Rear windscreen  
 Wiper shaft: w/ 1 M8 Shaft  
 Auto stop: No

**UNIVERSAL**
**160032 Wiper Motor**

Fitted w/ an interchangeable bearing allowing the shaft to be cut in any size.

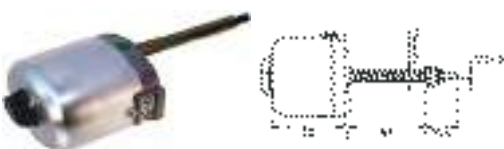

Voltage: 24

Wiper angle: 85°

Type: Universal  
 Built in switch: Yes  
 Auto stop: No



**160034 Wiper Motor**

*Fitted w/ an interchangeable bearing allowing the shaft to be cut in any size.*



Voltage: 24

Wiper angle: 110°

Type: Universal  
**Built in switch:** Yes  
**Auto stop:** Yes

**160291 Wiper Motor**

*w/ reciprocating shaft.*



Voltage: 24

Dist./shafts: 57 mm  
 Wiper angle: 95°

Type: Universal  
**Wiper shaft:** w/ 2 shafts for parallelogram  
**Auto stop:** Yes  
**Auto stop/placement:** Left side

**160293 Wiper Motor**

*w/ reciprocating shaft.*



Voltage: 24

Dist./shafts: 57 mm  
 Wiper angle: 110°

Type: Universal  
**Wiper shaft:** w/ 2 shafts for parallelogram  
**Built in switch:** Yes  
**Auto stop:** No

**160408 Wiper Motor**

*w/ reciprocating shaft.*

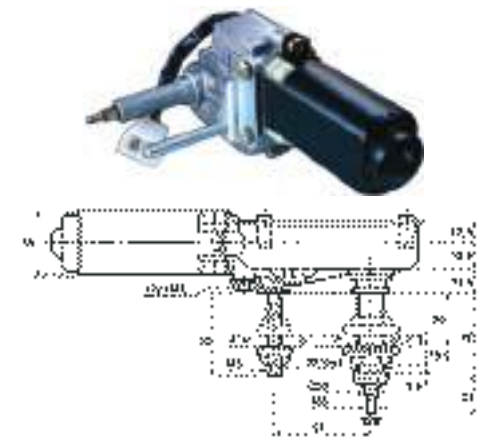

Voltage: 24

Dist./shafts: 57 mm  
 Wiper angle: 95°

Type: Universal  
**Wiper shaft:** w/ 2 shafts for parallelogram  
**Auto stop:** Yes

**160504 Wiper Motor**

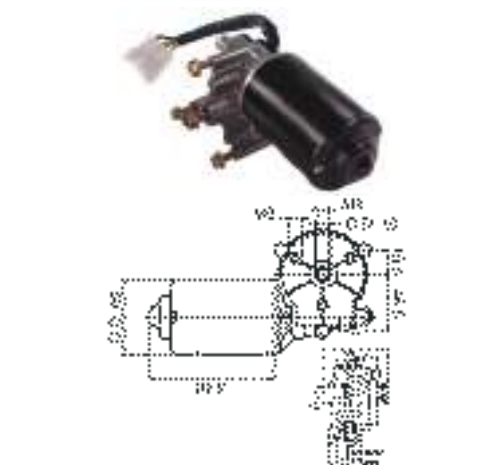

Voltage: 24

Type: Universal  
**Auto stop:** Yes





# Workshop Consumables

Edition 2016/2017

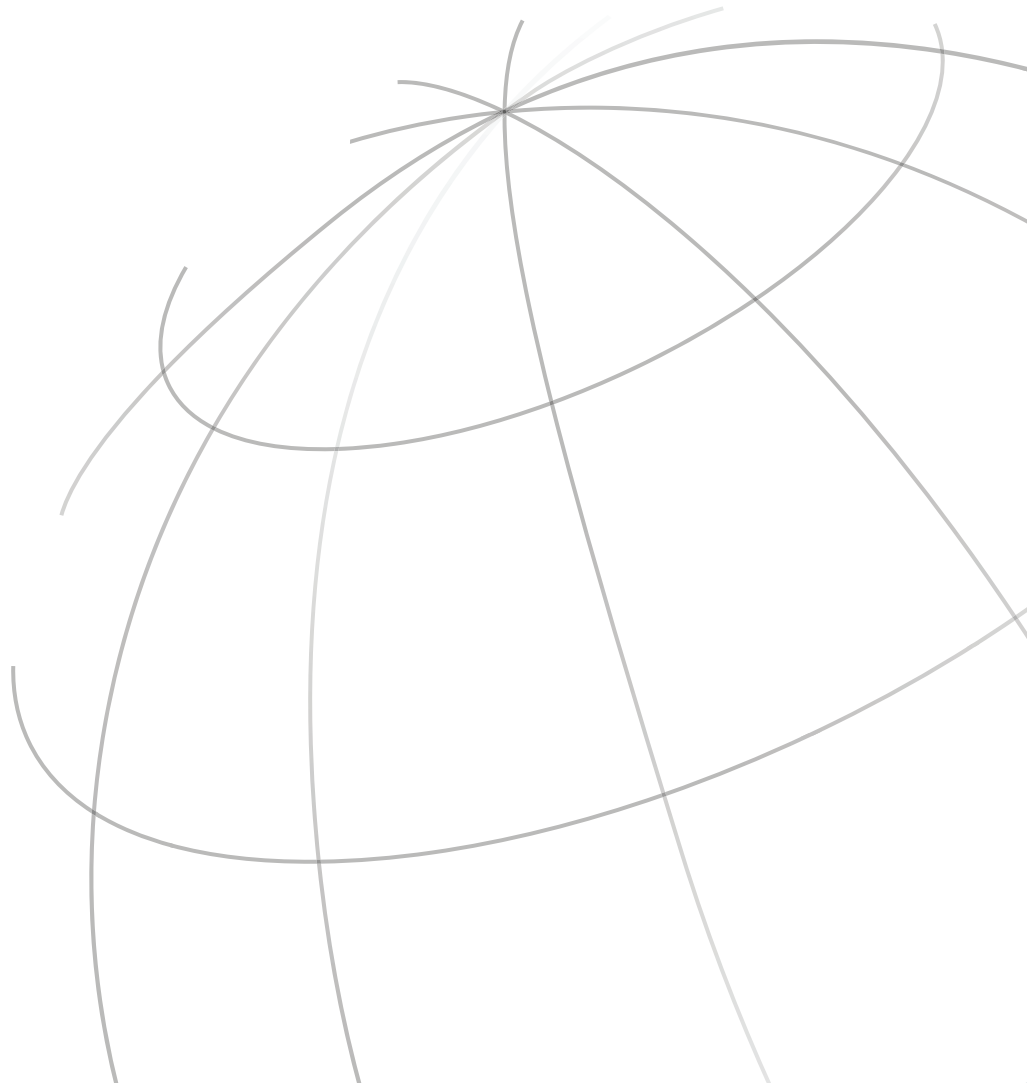

**CABLE & WIRING**
**CONNECTORS**

<b>193128</b> Connector 10-7.5-10		Servicing: HC-CARGO 193122, 193121	
		Size 1: 10 mm Size 2: 7.5 mm Size 3: 10 mm Temp.: -40 - +135 °C	Type: T Colour: Black Material: Polyamid
<b>193129</b> Connector 10-10-10		Servicing: HC-CARGO 193122	
		Size 1: 10 mm Size 2: 10 mm Size 3: 10 mm Temp.: -40 - +135 °C	Type: T Colour: Black Material: Polyamid
<b>193130</b> Connector 13-7.5-13		Servicing: HC-CARGO 193123, 193121	
		Size 1: 13 mm Size 2: 7.5 mm Size 3: 13 mm Temp.: -40 - +135 °C	Type: T Colour: Black Material: Polyamid
<b>193131</b> Connector 13-10-13		Servicing: HC-CARGO 193123, 193122	
		Size 1: 13 mm Size 2: 10 mm Size 3: 13 mm Temp.: -40 - +135 °C	Type: T Colour: Black Material: Polyamid
<b>193132</b> Connector 17-7.5-13		Servicing: HC-CARGO 193124, 193123, 193121	
		Size 1: 17 mm Size 2: 7.5 mm Size 3: 13 mm Temp.: -40 - +135 °C	Type: T Colour: Black Material: Polyamid
<b>193133</b> Connector 17-7.5-17		Servicing: HC-CARGO 193124, 193121	
		Size 1: 17 mm Size 2: 7.5 mm Size 3: 17 mm Temp.: -40 - +135 °C	Type: T Colour: Black Material: Polyamid
<b>193134</b> Connector 17-10-13		Servicing: HC-CARGO 193124, 193123, 193122	
		Size 1: 17 mm Size 2: 10 mm Size 3: 13 mm Temp.: -40 - +135 °C	Type: T Colour: Black Material: Polyamid

EL. SPECIFICATIONS	DIMENSIONS	ADDITIONAL SPECIFICATIONS
<b>193135</b> Connector 17-10-17 	Servicing: HC-CARGO 193124, 193122  Size 1: 17 mm Size 2: 10 mm Size 3: 17 mm Temp.: -40 - +135 °C	Type: T Colour: Black Material: Polyamid
<b>193136</b> Connector 17-13-13 	Servicing: HC-CARGO 193124, 193123  Size 1: 17 mm Size 2: 13 mm Size 3: 13 mm Temp.: -40 - +135 °C	Type: T Colour: Black Material: Polyamid
<b>193137</b> Connector 17-13-17 	Servicing: HC-CARGO 193124, 193123  Size 1: 17 mm Size 2: 13 mm Size 3: 17 mm Temp.: -40 - +135 °C	Type: T Colour: Black Material: Polyamid
<b>193138</b> Connector 17-22-17 	Servicing: HC-CARGO 193124, 193125  Size 1: 17 mm Size 2: 22 mm Size 3: 17 mm Temp.: -40 - +135 °C	Type: T Colour: Black Material: Polyamid
<b>193139</b> Connector 22-10-10 	Servicing: HC-CARGO 193125, 193122  Size 1: 22 mm Size 2: 10 mm Size 3: 10 mm Temp.: -40 - +135 °C	Type: T Colour: Black Material: Polyamid
<b>193140</b> Connector 22-10-22 	Servicing: HC-CARGO 193125, 193122  Size 1: 22 mm Size 2: 10 mm Size 3: 22 mm Temp.: -40 - +135 °C	Type: T Colour: Black Material: Polyamid
<b>193141</b> Connector 22-13-17 	Servicing: HC-CARGO 193125, 193124, 193123  Size 1: 22 mm Size 2: 13 mm Size 3: 17 mm Temp.: -40 - +135 °C	Type: T Colour: Black Material: Polyamid



EL. SPECIFICATIONS	DIMENSIONS	ADDITIONAL SPECIFICATIONS
<b>193142</b> Connector 22-13-22 	Servicing: HC-CARGO 193125, 193123  Size 1: 22 mm Size 2: 13 mm Size 3: 22 mm Temp.: -40 - +135 °C	Type: T Colour: Black Material: Polyamid
<b>193143</b> Connector 22-17-13 	Servicing: HC-CARGO 193125, 193124, 193123  Size 1: 22 mm Size 2: 17 mm Size 3: 13 mm Temp.: -40 - +135 °C	Type: T Colour: Black Material: Polyamid
<b>193144</b> Connector 22-22-22 	Servicing: HC-CARGO 193125  Size 1: 22 mm Size 2: 22 mm Size 3: 22 mm Temp.: -40 - +135 °C	Type: T Colour: Black Material: Polyamid
<b>193145</b> Connector 26-10-26 	Servicing: HC-CARGO 193126, 193122  Size 1: 26 mm Size 2: 10 mm Size 3: 26 mm Temp.: -40 - +135 °C	Type: T Colour: Black Material: Polyamid
<b>193146</b> Connector 26-13-22 	Servicing: HC-CARGO 193126, 193125, 193123  Size 1: 26 mm Size 2: 13 mm Size 3: 22 mm Temp.: -40 - +135 °C	Type: T Colour: Black Material: Polyamid
<b>193147</b> Connector 26-13-26 	Servicing: HC-CARGO 193126, 193123  Size 1: 26 mm Size 2: 13 mm Size 3: 26 mm Temp.: -40 - +135 °C	Type: T Colour: Black Material: Polyamid
<b>193148</b> Connector 26-17-17 	Servicing: HC-CARGO 193126, 193124  Size 1: 26 mm Size 2: 17 mm Size 3: 17 mm Temp.: -40 - +135 °C	Type: T Colour: Black Material: Polyamid

EL. SPECIFICATIONS	DIMENSIONS	ADDITIONAL SPECIFICATIONS
<b>193149</b> Connector 26-17-22 	Servicing: HC-CARGO 193126, 193125, 193124 Size 1: 26 mm Size 2: 17 mm Size 3: 22 mm Temp.: -40 - +135 °C	Type: T Colour: Black Material: Polyamid
<b>193150</b> Connector 26-26-26 	Servicing: HC-CARGO 193126 Size 1: 26 mm Size 2: 26 mm Size 3: 26 mm Temp.: -40 - +135 °C	Type: T Colour: Black Material: Polyamid
<b>193151</b> Connector 13-13-13 	Servicing: HC-CARGO 193123 Size 1: 13 mm Size 2: 13 mm Size 3: 13 mm Temp.: -40 - +135 °C	Type: T Colour: Black Material: Polyamid
<b>193152</b> Connector 10-7.5-7.5 	Servicing: HC-CARGO 193122, 193121 Size 1: 10 mm Size 2: 7.5 mm Size 3: 7.5 mm Temp.: -40 - +135 °C	Type: T Colour: Black Material: Polyamid
<b>193153</b> Connector 13-10-10 	Servicing: HC-CARGO 193123, 193122 Size 1: 13 mm Size 2: 10 mm Size 3: 10 mm Temp.: -40 - +135 °C	Type: T Colour: Black Material: Polyamid
<b>193154</b> Connector 17-13-17 	Servicing: HC-CARGO 193124, 193123 Size 1: 17 mm Size 2: 13 mm Size 3: 17 mm Temp.: -40 - +135 °C	Type: Y Colour: Black Material: Polyamid
<b>193155</b> Connector 22-10-17 	Servicing: HC-CARGO 193125, 193124, 193122 Size 1: 22 mm Size 2: 10 mm Size 3: 17 mm Temp.: -40 - +135 °C	Type: Y Colour: Black Material: Polyamid

EL. SPECIFICATIONS	DIMENSIONS	ADDITIONAL SPECIFICATIONS
<b>193156</b> Connector 22-13-17 	Servicing: HC-CARGO 193125, 193124, 193123 Size 1: 22 mm Size 2: 13 mm Size 3: 17 mm Temp.: -40 - +135 °C	Type: Y Colour: Black Material: Polyamid
<b>193157</b> Connector 13-7.5-10 	Servicing: HC-CARGO 193123, 193122, 193121 Size 1: 13 mm Size 2: 7.5 mm Size 3: 10 mm Temp.: -40 - +135 °C	Type: Y Colour: Black Material: Polyamid
<b>193158</b> Connector 13-10-10 	Servicing: HC-CARGO 193123, 193122 Size 1: 13 mm Size 2: 10 mm Size 3: 10 mm Temp.: -40 - +135 °C	Type: Y Colour: Black Material: Polyamid
<b>193159</b> Connector 13-10-13 	Servicing: HC-CARGO 193123, 193122 Size 1: 13 mm Size 2: 10 mm Size 3: 13 mm Temp.: -40 - +135 °C	Type: Y Colour: Black Material: Polyamid
<b>193160</b> Connector 13-13-13 	Servicing: HC-CARGO 193123 Size 1: 13 mm Size 2: 13 mm Size 3: 13 mm Temp.: -40 - +135 °C	Type: Y Colour: Black Material: Polyamid
<b>193161</b> Connector 17-13-10 	Servicing: HC-CARGO 193124, 193123, 193122 Size 1: 17 mm Size 2: 13 mm Size 3: 10 mm Temp.: -40 - +135 °C	Type: Y Colour: Black Material: Polyamid
<b>193162</b> Connector 26-22-22 	Servicing: HC-CARGO 193126, 193125 Size 1: 26 mm Size 2: 22 mm Size 3: 22 mm Temp.: -40 - +135 °C	Type: Y Colour: Black Material: Polyamid

EL. SPECIFICATIONS	DIMENSIONS	ADDITIONAL SPECIFICATIONS
<b>193163</b> Connector 10-10-10 	Servicing: HC-CARGO 193122 Size 1: 10 mm Size 2: 10 mm Size 3: 10 mm Temp.: -40 - +135 °C	Type: Y Colour: Black Material: Polyamid
<b>193164</b> Connector 7.5-7.5-7.5 	Servicing: HC-CARGO 193121 Size 1: 7.5 mm Size 2: 7.5 mm Size 3: 7.5 mm Temp.: -40 - +135 °C	Type: T Colour: Black Material: Polyamid
<b>193165</b> Connector 22-7.5-22 	Servicing: HC-CARGO 193121, 193125 Size 1: 22 mm Size 2: 7.5 mm Size 3: 22 mm Temp.: -40 - +135 °C	Type: T Colour: Black Material: Polyamid
<b>193212</b> Connector 17-17-17 	Servicing: HC-CARGO 193124 Size 1: 17 mm Size 2: 17 mm Size 3: 17 mm Temp.: -40 - +135 °C	Type: T Colour: Black Material: Polyamid

## FLEXIBLE CONVOLUTED TUBING

<b>193121</b> Flexible Convoluted Tubing - Non split UL: 94HB. 	ID: 6.6 mm OD: 10 mm Length: 50 m	Colour: Black Material: Nylon 66 ISO norm: 9772 ISO norm 2: 9773
<b>193122</b> Flexible Convoluted Tubing - Non split UL: 94HB. 	ID: 9.8 mm OD: 13 mm Length: 50 m	Colour: Black Material: Nylon 66 ISO norm: 9772 ISO norm 2: 9773
<b>193123</b> Flexible Convoluted Tubing - Non split UL: 94HB. 	ID: 12.2 mm OD: 15.8 mm Length: 50 m	Colour: Black Material: Nylon 66 ISO norm: 9772 ISO norm 2: 9773

**193124** Flexible Convoluted Tubing - Non split

 ID: 17.2 mm  
 OD: 20 mm  
 Length: 100 m

 Colour: Black  
 Material: Polypropylene

**193125** Flexible Convoluted Tubing - Non split

 ID: 21.2 mm  
 OD: 25.8 mm  
 Length: 100 m

 Colour: Black  
 Material: Polypropylene

**193126** Flexible Convoluted Tubing - Non split

 ID: 25 mm  
 OD: 30 mm  
 Length: 50 m

 Colour: Black  
 Material: Polypropylene

**193127** Flexible Convoluted Tubing - Non split

 ID: 28 mm  
 OD: 34 mm  
 Length: 50 m

 Colour: Black  
 Material: Polypropylene

## INDICATOR LIGHTS

**180014** Indicator Light

Voltage: 12/24

 Mount. hole size:  
 17 mm

 Socket type: BA9s  
 Colour: Blue  
 Material: Shockproof plastic  
 No./terminals w/screw: 2  
 Bulb incl.: Yes  
 DIN norm: 72601

**180015** Indicator Light

Voltage: 12/24

 Mount. hole size:  
 17 mm

 Socket type: BA9s  
 Colour: Orange  
 Material: Shockproof plastic  
 No./terminals w/screw: 2  
 Bulb incl.: No  
 DIN norm: 72601

**180016** Indicator Light

Voltage: 12/24

 Mount. hole size:  
 17 mm

 Socket type: BA9s  
 Colour: Green  
 Material: Shockproof plastic  
 No./terminals w/screw: 2  
 Bulb incl.: Yes  
 DIN norm: 72601



**180017** Indicator Light

Voltage: 12/24

 Mount. hole size:  
17 mm

 Socket type: BA9s  
 Colour: Red  
 Material: Shockproof plastic  
 No./terminals w/screw: 2  
 Bulb incl.: Yes  
 DIN norm: 72601

**180346** Indicator Light

 Voltage: 24  
 Watt: 1.2

 Terminals: 2.8 mm  
 Mount. hole size:  
10 mm

 Type/terminal: Flat  
 Colour: Orange  
 Material: Shockproof plastic  
 Terminals: 2  
 Bulb incl.: Yes

**180347** Indicator Light

 Voltage: 24  
 Watt: 1.2

 Terminals: 2.8 mm  
 Mount. hole size:  
10 mm

 Type/terminal: Flat  
 Colour: Green  
 Material: Shockproof plastic  
 Terminals: 2  
 Bulb incl.: Yes

**180348** Indicator Light

 Voltage: 24  
 Watt: 1.2

 Terminals: 2.8 mm  
 Mount. hole size:  
10 mm

 Type/terminal: Flat  
 Colour: Red  
 Material: Shockproof plastic  
 Terminals: 2  
 Bulb incl.: Yes

**LED**
**181570** Indicator Light

EN60947-5-1, IEC947-5-1.

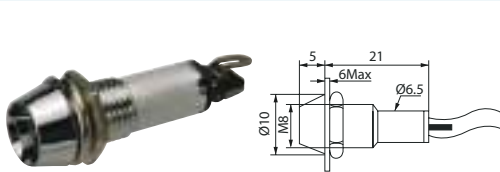

Voltage: 24

 Mount. hole size:  
8 mm

 Type/terminal: Solder  
 Colour: Red  
 Material: Nickel plated brass  
 Bulb: LED

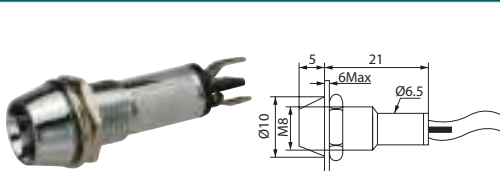
**181571** Indicator Light

Voltage: 24

 Mount. hole size:  
8 mm

 Type/terminal: Solder  
 Colour: Green  
 Material: Nickel plated brass  
 Bulb: LED

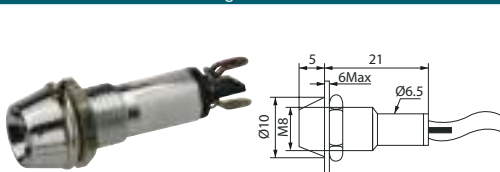
**181572** Indicator Light

Voltage: 24

 Mount. hole size:  
8 mm

 Type/terminal: Solder  
 Colour: Yellow  
 Material: Nickel plated brass  
 Bulb: LED

**181573** Indicator Light

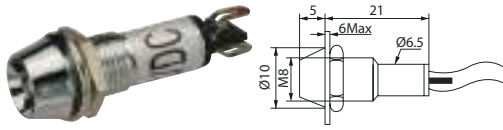

Voltage: 24

Mount. hole size:  
8 mm

Type/terminal: Solder  
Colour: Blue  
Material: Nickel plated brass  
Bulb: LED

**181574** Indicator Light

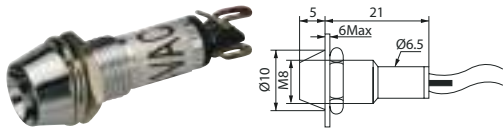

Voltage: 24

Mount. hole size:  
8 mm

Type/terminal: Solder  
Colour: White  
Material: Nickel plated brass  
Bulb: LED

**INDUSTRIAL BATTERY CONNECTORS**

**50 AMPERE**

**180381** Battery Connector



Voltage: 600  
Amp: 50

Cable dim.: 16 mm<sup>2</sup>  
Temp./max: +125 °C  
Temp./min: -40 °C

Type: Female  
Mount.: Solder/crimp  
Model: CB50  
Colour: Grey  
Material: Polycarbonate  
Material 2: Electrolytic copper w/  
galvanic silver plating  
Solvent: Yes  
Resistant to acid: Yes  
Hydrocarbons: Yes

**180382** Battery Connector



Voltage: 600  
Amp: 50

Cable dim.: 16 mm<sup>2</sup>  
Temp./max: +125 °C  
Temp./min: -40 °C

Type: Female  
Mount.: Solder/crimp  
Model: CB50  
Colour: Red  
Material: Polycarbonate  
Material 2: Electrolytic copper w/  
galvanic silver plating  
Solvent: Yes  
Resistant to acid: Yes  
Hydrocarbons: Yes

**180383** Battery Connector



Voltage: 600  
Amp: 50

Cable dim.: 16 mm<sup>2</sup>  
Temp./max: +125 °C  
Temp./min: -40 °C

Type: Female  
Mount.: Solder/crimp  
Model: CB50  
Colour: Black  
Material: Polycarbonate  
Material 2: Electrolytic copper w/  
galvanic silver plating  
Solvent: Yes  
Resistant to acid: Yes  
Hydrocarbons: Yes

**180530** Battery Connector



Voltage: 600  
Amp: 50

Cable dim.: 6 mm<sup>2</sup>  
Temp./max: +125 °C  
Temp./min: -40 °C

Type: Female  
Mount.: Solder/crimp  
Model: CB50  
Colour: Grey  
Material: Polycarbonate  
Material 2: Electrolytic copper w/  
galvanic silver plating  
Solvent: Yes  
Resistant to acid: Yes  
Hydrocarbons: Yes

	EL. SPECIFICATIONS	DIMENSIONS	ADDITIONAL SPECIFICATIONS
<b>180531 Battery Connector</b>			
	Voltage: 600 Amp: 50	Cable dim.: 6 mm <sup>2</sup> Temp./max: +125 °C Temp./min: -40 °C	Type: Female Mount.: Solder/crimp Model: CB50 Colour: Red Material: Polycarbonate Material 2: Electrolytic copper w/ galvanic silver plating Solvent: Yes Resistant to acid: Yes Hydrocarbons: Yes
<b>180532 Battery Connector</b>			
	Voltage: 600 Amp: 50	Cable dim.: 6 mm <sup>2</sup> Temp./max: +125 °C Temp./min: -40 °C	Type: Female Mount.: Solder/crimp Model: CB50 Colour: Black Material: Polycarbonate Material 2: Electrolytic copper w/ galvanic silver plating Solvent: Yes Resistant to acid: Yes Hydrocarbons: Yes
<b>SPARE PARTS</b>			
<b>180390 Terminals</b>			
	Voltage: 600 Amp: 50	Cable dim.: 16 mm <sup>2</sup>	Servicing: HC-CARGO 180381, -382, -383
<b>180535 Terminals</b>			
	Voltage: 600 Amp: 50	Cable dim.: 6 mm <sup>2</sup>	Servicing: HC-CARGO 180530, -531, -532
<b>ACCESSORIES</b>			
<b>180548 Handle</b>			
			Colour: Red
<b>181516 Dust Cap</b>			
			Servicing: CB50

## 80 AMPERE

### 180542 Battery Connector



Voltage: 150  
Amp: 80

Cable dim.: 25 mm<sup>2</sup>  
Temp./max: +90 °C  
Temp./min: -20 °C

Type: Female  
Mount.: Solder/crimp  
Model: NF80  
Colour: Black  
Material: Plastic  
Material 2: Silver plated copper alloy  
Resistant to acid: Yes  
Protection degree: IP 23

### 180543 Battery Connector



Voltage: 150  
Amp: 80

Cable dim.: 25 mm<sup>2</sup>  
Temp./max: +90 °C  
Temp./min: -20 °C

Type: Male  
Mount.: Solder/crimp  
Model: NF80  
Colour: Black  
Material: Plastic  
Material 2: Silver plated copper alloy  
Resistant to acid: Yes  
Protection degree: IP 23

### 180562 Battery Connector



Voltage: 150  
Amp: 80

Cable dim.: 16 mm<sup>2</sup>  
Temp./max: +90 °C  
Temp./min: -20 °C

Type: Female  
Mount.: Solder/crimp  
Model: NF80  
Colour: Black  
Material: Plastic  
Material 2: Silver plated copper alloy  
Resistant to acid: Yes  
Protection degree: IP 23

### 180563 Battery Connector



Voltage: 150  
Amp: 80

Cable dim.: 16 mm<sup>2</sup>  
Temp./max: +90 °C  
Temp./min: -20 °C

Type: Male  
Mount.: Solder/crimp  
Model: NF80  
Colour: Black  
Material: Plastic  
Material 2: Silver plated copper alloy  
Resistant to acid: Yes  
Protection degree: IP 23

## 100 AMPERE

### 181501 Battery Connector



Voltage: 150  
Amp: 100

Cable dim.: 16 mm<sup>2</sup>  
Temp./max: +90 °C  
Temp./min: -20 °C

Type: Female  
Mount.: Solder/crimp  
Colour: Black  
Material: Plastic  
Material 2: Silver plated copper alloy  
Resistant to acid: Yes  
Protection degree: IP 23

### 181502 Battery Connector



Voltage: 150  
Amp: 100

Cable dim.: 16 mm<sup>2</sup>  
Temp./max: +90 °C  
Temp./min: -20 °C

Type: Male  
Mount.: Solder/crimp  
Colour: Black  
Material: Plastic  
Material 2: Silver plated copper alloy  
Resistant to acid: Yes  
Protection degree: IP 23

### 181503 Battery Connector



Voltage: 150  
Amp: 100

Cable dim.: 25 mm<sup>2</sup>  
Temp./max: +90 °C  
Temp./min: -20 °C

Type: Female  
Mount.: Solder/crimp  
Colour: Black  
Material: Silver plated copper alloy  
Resistant to acid: Yes  
Protection degree: IP 23

**181504** Battery Connector Kit



Voltage: 150  
Amp: 100

Cable dim.: 25 mm<sup>2</sup>  
Temp./max: +90 °C  
Temp./min: -20 °C

Type: Male  
Mount.: Solder/crimp  
Colour: Black  
Material: Plastic  
Material 2: Silver plated copper alloy  
Resistant to acid: Yes  
Protection degree: IP 23

**ACCESSORIES**

**181505** Handle

Servicing: HC-CARGO 181501, 181502, 181503, 181504



Colour: Red

**160 AMPERE**

**181519** Battery Connector

Delivered w/o derate set 50/35.



Voltage: 150  
Amp: 160

Cable dim.: 50 mm<sup>2</sup>  
Temp./max: +90 °C  
Temp./min: -20 °C

Type: Female  
Mount.: Solder/crimp  
Model: NF160  
Colour: Black  
Material: Plastic  
Material 2: Silver plated copper alloy  
Resistant to acid: Yes  
Protection degree: IP 23

**181520** Battery Connector Kit

Delivered w/o derate set 50/35.



Voltage: 150  
Amp: 160

Cable dim.: 50 mm<sup>2</sup>  
Temp./max: +90 °C  
Temp./min: -20 °C

Type: Male  
Mount.: Solder/crimp  
Model: NF160  
Colour: Black  
Material: Plastic  
Material 2: Silver plated copper alloy  
Resistant to acid: Yes  
Protection degree: IP 23

**ACCESSORIES**

**180380** Handle

Servicing: HC-CARGO 180395, 180396, 181519, 181520



Colour: Black

**181521** Reducer Kit

Servicing: HC-CARGO 181519, 181520



Voltage: 150  
Amp: 160

Cable dim.: 50/35 mm<sup>2</sup>



**175 AMPERE**
**180384 Battery Connector**

 Voltage: 600  
Amp: 175

 Cable dim.: 50 mm<sup>2</sup>  
Temp./max: +125 °C  
Temp./min: -40 °C

 Type: Female  
Mount.: Solder/crimp  
Model: CB175  
Colour: Grey  
Material: Polycarbonate  
Material 2: Electrolytic copper w/  
galvanic silver plating  
Solvent: Yes  
Resistant to acid: Yes  
Hydrocarbons: Yes

**180385 Battery Connector**

79.4x55.6x25.4 mm.

 Voltage: 600  
Amp: 175

 Cable dim.: 50 mm<sup>2</sup>  
Temp./max: +125 °C  
Temp./min: -40 °C

 Type: Female  
Mount.: Solder/crimp  
Model: CB175  
Colour: Red  
Material: Polycarbonate  
Material 2: Electrolytic copper w/  
galvanic silver plating  
Solvent: Yes  
Resistant to acid: Yes  
Hydrocarbons: Yes

**180533 Battery Connector**

 Voltage: 600  
Amp: 175

 Cable dim.: 35 mm<sup>2</sup>  
Temp./max: +125 °C  
Temp./min: -40 °C

 Type: Female  
Mount.: Solder/crimp  
Model: CB175  
Colour: Grey  
Material: Polycarbonate  
Material 2: Electrolytic copper w/  
galvanic silver plating  
Solvent: Yes  
Resistant to acid: Yes  
Hydrocarbons: Yes

**180534 Battery Connector**

 Voltage: 600  
Amp: 175

 Cable dim.: 35 mm<sup>2</sup>  
Temp./max: +125 °C  
Temp./min: -40 °C

 Type: Female  
Mount.: Solder/crimp  
Model: CB175  
Colour: Red  
Material: Polycarbonate  
Material 2: Electrolytic copper w/  
galvanic silver plating  
Solvent: Yes  
Resistant to acid: Yes  
Hydrocarbons: Yes

**180537 Battery Connector**

Can replace CBE160, except yellow.

 Voltage: 600  
Amp: 175

 Cable dim.: 50 mm<sup>2</sup>  
Temp./max: +125 °C  
Temp./min: -40 °C

 Type: Female  
Mount.: Solder/crimp  
Model: CB175  
Colour: Grey  
Material: Polycarbonate  
Material 2: Electrolytic copper w/  
galvanic silver plating

**180538 Battery Connector**

Can replace CBE160, except yellow.

 Voltage: 600  
Amp: 175

 Cable dim.: 50 mm<sup>2</sup>  
Temp./max: +125 °C  
Temp./min: -40 °C

 Type: Female  
Mount.: Solder/crimp  
Model: CB175  
Colour: Red  
Material: Polycarbonate  
Material 2: Electrolytic copper w/  
galvanic silver plating

**SPARE PARTS**
**180392** Terminals

Servicing: HC-CARGO 180384, -385

 Voltage: 600  
Amp: 175

 Cable dim.: 50 mm<sup>2</sup>
**180536** Terminals

Servicing: HC-CARGO 180533, 180534

 Voltage: 600  
Amp: 175

 Cable dim.: 35 mm<sup>2</sup>
**180554** Terminals

Servicing: HC-CARGO 180537, -538

 Voltage: 600  
Amp: 175

 Cable dim.: 50 mm<sup>2</sup>
**ACCESSORIES**
**180391** Handle

Servicing: HC-CARGO 180533, -534, -537, -538, -384, -385



Colour: Red

**180549** Handle

Servicing: HC-CARGO 180533, -534, -537, -538, -384, -385



Colour: Grey

**181517** Dust Cap

Servicing: CB175

**250 AMPERE**
**180580** Battery Connector

 Voltage: 150  
Amp: 250

 Cable dim.: 50 mm<sup>2</sup>

 Type: Male  
Mount.: Soldering  
Model: Y250  
Colour: Yellow  
Material: Thermoplastic  
Material 2: Copper alloy

**180581** Battery Connector

 Voltage: 250  
 Amp: 250

 Cable dim.: 50 mm<sup>2</sup>

 Type: Female  
 Mount.: Soldering  
 Model: P250  
 Colour: Black  
 Material: Thermoplastic  
 Material 2: Copper alloy

**SPARE PARTS**
**181605** Terminals

Servicing: HC-CARGO 180581



Amp: 250

Gender: Female

**181606** Terminals

Servicing: HC-CARGO 180580



Amp: 250

Gender: Male

**ACCESSORIES**
**180582** Terminals

Servicing: HC-CARGO 180580

*Single delivered.*

Amp: 250

Gender: Male

**180583** Terminals

Servicing: HC-CARGO 180581

*Single delivered.*

Amp: 250

Gender: Female

**181328** Rubber Boot

Servicing: HC-CARGO 180580



Protection degree: IP 66

**181329** Lid

Servicing: HC-CARGO 180581

*Self-closed.*

## 300 AMPERE

### 180575 Battery Connector

Shells: stamped steel and coated w/ yellow paint. Insulators: DMC mouldings. Terminals w/ brazed solid silver tip.



Voltage: 250  
Amp: 300

Cable dim.: 70 mm<sup>2</sup>

Mount.: Soldering  
Model: E300  
Colour: Yellow  
Material: Copper alloy  
Bracket: w/

### 180577 Battery Connector

Shells: stamped steel and coated w/ yellow paint. Insulators: DMC mouldings. Terminals w/ brazed solid silver tip.



Voltage: 250  
Amp: 300

Cable dim.: 70 mm<sup>2</sup>

Mount.: Soldering  
Model: E300  
Colour: Yellow  
Material: Copper alloy  
Bracket: w/

## 320 AMPERE

### 180395 Battery Connector

w/ reducing bushings for 70 mm<sup>2</sup> cable.



Voltage: 150  
Amp: 320

Cable dim.: 90/70 mm<sup>2</sup>  
Temp./max: +90 °C  
Temp./min: -20 °C

Type: Female  
Mount.: Solder/crimp  
Model: NF320  
Colour: Black  
Material: Plastic  
Material 2: Silver plated copper alloy  
Resistant to acid: Yes  
Protection degree: IP 23

### 180396 Battery Connector

w/ reducing bushings for 70 mm<sup>2</sup> cable.



Voltage: 150  
Amp: 320

Cable dim.: 90/70 mm<sup>2</sup>  
Temp./max: +90 °C  
Temp./min: -20 °C

Type: Male  
Mount.: Solder/crimp  
Model: NF320  
Colour: Black  
Material: Plastic  
Material 2: Silver plated copper alloy  
Resistant to acid: Yes  
Protection degree: IP 23

## ACCESSORIES

### 180616 Terminals

Servicing: HC-CARGO 180395



Voltage: 150  
Amp: 160

Type: Female

## 350 AMPERE

### 180386 Battery Connector



Voltage: 600  
Amp: 350

Cable dim.: 70 mm<sup>2</sup>  
Temp./max: +125 °C  
Temp./min: -40 °C

Type: Female  
Mount.: Solder/crimp  
Model: CB350  
Colour: Grey  
Material: Polycarbonate  
Material 2: Electrolytic copper w/  
galvanic silver plating  
Solvent: Yes  
Resistant to acid: Yes  
Hydrocarbons: Yes

**180387** Battery Connector

 Voltage: 600  
Amp: 350

 Cable dim.: 70 mm<sup>2</sup>  
Temp./max: +125 °C  
Temp./min: -40 °C

 Type: Female  
Mount.: Solder/crimp  
Model: CB350  
Colour: Red  
Material: Polycarbonate  
Material 2: Electrolytic copper w/  
galvanic silver plating  
Solvent: Yes  
Resistant to acid: Yes  
Hydrocarbons: Yes

**180551** Battery Connector

 Voltage: 600  
Amp: 350

 Cable dim.: 70 mm<sup>2</sup>  
Temp./max: +125 °C  
Temp./min: -40 °C

 Type: Female  
Mount.: Solder/crimp  
Model: CBX350  
Colour: Grey  
Material: Polycarbonate  
Material 2: Electrolytic copper w/  
galvanic silver plating

**180552** Battery Connector

 Voltage: 600  
Amp: 350

 Cable dim.: 70 mm<sup>2</sup>  
Temp./max: +125 °C  
Temp./min: -40 °C

 Type: Female  
Mount.: Solder/crimp  
Model: CBX350  
Colour: Red  
Material: Polycarbonate  
Material 2: Electrolytic copper w/  
galvanic silver plating

**ACCESSORIES**
**180550** Handle

Servicing: HC-CARGO 180386, -387, 180551, -552



Colour: Grey

**MULTIPLE CONNECTORS**
**POWER**
**4 POLE**
**181545** Connector

Servicing: HC-CARGO 181476

DIN 72585.



Amp: 30

 Colour: Black  
No./poles: 4  
Plug: Male

**PLUGS & SOCKETS**
**ADAPTERS - 12/24 V**
**7-7 PIN**
**18201** Trailer Adapter

Voltage: 12-24

 Plug type: 24N, 12N  
Plug 1: 7  
Plug 2: 7  
ISO norm: 1724  
ISO norm 2: 1185



## ADAPTERS 12 V

### 15-7 PIN

#### 180327 Trailer Adapter

w/ 42 windings.



Voltage: 24

Cable dim.:  
6x1+1x2.5 mm<sup>2</sup>  
Cable length: 3.5 mm

Plug type: 24N/24S, Europe  
Colour: Black  
Material: Polyurethan  
Plug 1: 15  
Plug 2: 2x7  
Cable: w/  
ISO norm: 12098  
ISO norm 2: 1185  
ISO norm 3: 3731

#### 180622 Trailer Adapter



Voltage: 24

Plug type: 24N/24S  
Plug 1: 15  
Plug 2: 7  
ISO norm: 12098  
ISO norm 2: 1185  
ISO norm 3: 3721

## DIN AND CIGARETTE LIGHTER

#### 160551 Cigarette Lighter

Universal.



Voltage: 24

Light: w/

## PLUGS

#### 180230 DIN Plug

Universal plug suitable for all cigarette lighter sockets. Also suitable for standard DIN socket.



Voltage: 12/24  
Amp: <8

Material: Plastic  
No./poles: 2  
Male/female: Male  
ISO norm: 4165

#### 180287 DIN Plug

Universal plug suitable for all cigarette lighter sockets. Also suitable for standard DIN socket. w/ built-in 8 A fuse.



Voltage: 12/24

Material: Plastic  
No./poles: 2  
Male/female: Male  
ISO norm: 4165

#### 180399 DIN Plug

Universal. Fits HC-CARGO 180315.



Voltage: 12/24

Material: Plastic  
No./poles: 2  
Male/female: Male

**181629** DIN Plug

*Universal. Fits HC-CARGO 180315.*

Voltage: 12-24

 Material: Plastic  
 No./poles: 2  
 Male/female: Male

**SOCKETS**
**160409** Lighter Socket

*Universal.*

 Voltage: 12-24  
 Amp: 20

 Light: w/o  
 Cap: w/  
 Resistor: w/o  
 DIN norm: 53 505

**180038** DIN Socket

*Standard DIN.*

 ID/mount. hole:  
 18.5 mm

 Material: Nickel plated brass  
 No./mounting holes: 1  
 Cap: w/  
 Male/female: Female  
 DIN norm: 72591  
 ISO norm: 4165

**180115** DIN Socket

*Universal.*

 Dist. mount. holes:  
 46 mm

 Material: Cast aluminum  
 No./mounting holes: 2  
 No./poles: 2  
 Male/female: Female  
 DIN norm: 72591  
 ISO norm: 4165

**180157** DIN Socket

 ID/mount. hole:  
 18.5 mm

 Material: Nickel plated brass  
 No./poles: 2  
 Cap: w/  
 Male/female: Female  
 DIN norm: 72591  
 ISO norm: 4165

**180315** DIN Socket

*Universal. Fits HC-CARGO 180399, 181629.*

 Dist. mount. holes:  
 46 mm

 Material: Plastic  
 No./mounting holes: 2  
 No./poles: 2  
 Male/female: Female

**180376** DIN Socket

Servicing: HC-CARGO 170292, 170387, 170405, 170788, 170406, 170562, 170789, 170537, 171576, 170419, 170460

Also used in sockets for beacons.



ID/mount. hole:  
18.5 mm

Material: Brass  
No./poles: 1  
Male/female: Female  
DIN norm: 72591

**180377** DIN Socket

Also used in sockets for beacons.



ID/mount. hole:  
18.5 mm

Material: Brass  
No./poles: 2  
Male/female: Female  
DIN norm: 72591

**181550** Twin Socket Cigar Adapter

w/ 2 USB plugs. Cable length: 650 mm.



Voltage: 12-24  
Amp: 10

**181601** USB Adapter

2 horizontally built-in ports, charging two USB devices simultaneously.



Voltage: 12-24  
Amp: 3

Material: PVC

**181616** DIN Socket

300 mm cable.



Voltage: 6-24  
Amp: 16

Cable dim.: 2x2.5 mm<sup>2</sup>  
Mount. hole dia.:  
18.4 mm  
Temp.: -40 - +105 °C  
Connection: Cable

Mount.: Screw  
Colour: Black  
Material: Shockproof plastic  
No./poles: 2  
Male/female: Female  
ISO norm: 4165  
Protection degree: IP 67

**181631** USB Adapter

2 horizontally built-in ports, charging two USB devices simultaneously.



Voltage: 12-24  
Amp: 2.1

Colour: White/black  
Material: Polycarbonate

**ACCESSORIES**
**181579 Plug and Socket**

Servicing: HC-CARGO 181629, 180315



Voltage: 12-24

 Material: Plastic  
 No./mounting holes: 2  
 No./poles: 2

**NATO CABLE CONNECTORS**
**180197 Nato Socket**

Terminal: HC-CARGO 180560.

 Voltage: 24  
 Amp: 200

 Dim.: 35-50 mm<sup>2</sup>  
 Dist. mount. holes:  
 82.5/47.6 mm  
 Connection: Solder/  
 crimp

 No./mounting holes: 4  
 No./poles: 2  
 Male/female: Female  
 Approvals: VG 96917

**180198 Nato Plug**

Servicing: HC-CARGO 193002

 Voltage: 24  
 Amp: 200

 Dim.: 50 mm<sup>2</sup>  
 Connection: Solder/  
 crimp

 No./poles: 2  
 Male/female: Male  
 Approvals: VG 96917

**180325 Nato Plug**

w/ screw device.

 Voltage: 24  
 Amp: 200

 Dim.: 50 mm<sup>2</sup>  
 Connection: Solder/  
 crimp

 Material: Metal/Rubber  
 No./poles: 2  
 Male/female: Male

**180349 Nato Socket**

 Voltage: 24  
 Amp: 250

 Dim.: 70 mm<sup>2</sup>  
 Dist. mount. holes:  
 85/60 mm  
 Connection: 10 mm  
 ring terminals

 No./mounting holes: 4  
 No./poles: 2  
 Male/female: Female

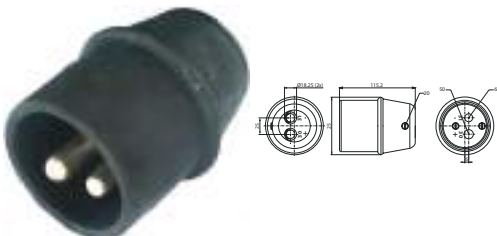
**180350 Nato Plug**

 Voltage: 24  
 Amp: 250

 Dim.: 70 mm<sup>2</sup>  
 Connection: Soldering

 No./poles: 2  
 Male/female: Male

**181563 Nato Plug**

Servicing: HC-CARGO 180197

 Voltage: 24  
 Amp: 200

 Dim.: 50 mm<sup>2</sup>  
 Connection: Solder/  
 crimp

 No./poles: 2  
 Male/female: Male

**181611** Nato Plug

Servicing: HC-CARGO 180197

Terminal: HC-CARGO 180561.



Voltage: 24  
Amp: Max 300

Dim.: 35 mm<sup>2</sup>  
Connection: Solder/  
crimp

Material: Aluminium  
No./poles: 2  
Male/female: Male  
Approvals: VG 96917

**181630** Nato Socket

Terminal: HC-CARGO 180560.



Voltage: 24

Dim.: 35-50 mm<sup>2</sup>

Colour: Yellow/black  
No./mounting holes: 4  
No./poles: 2  
Male/female: Female  
Approvals: VG 96917

**193002** Nato Socket 2-pin

Servicing: HC-CARGO 180198

Terminal: HC-CARGO 180560.



Voltage: 24

Dim.: 35 mm<sup>2</sup>  
ID/mount. hole: 6 mm  
Dist. mount. holes:  
82x49 mm  
Connection: Soldering

Colour: Black  
Material: Plastic  
No./mounting holes: 4  
No./poles: 2  
Cap: w/  
Male/female: Female  
Approvals: VG 96917

**ACCESSORIES**

**180199** Nato Coupling



Voltage: 24  
Amp: 200

Dim.: 35-50 mm<sup>2</sup>

No./poles: 2  
Approvals: VG 96917

**181671** Rubber Gasket

Servicing: HC-CARGO 180197, 181630, 193002



Colour: Black  
Material: EPDM rubber

**TRAILER COILS 24 V**

**2 PIN**

**181489** Trailer Coil



Voltage: 24

Cable dim.: 2x35 mm<sup>2</sup>  
Working length: 4 m

Plug type: Nato plug, Nato plug  
Colour: Red/black  
Material: Polyurethan  
Windings: 35  
Plug 1: 2  
Plug 2: 2



**5 PIN**
**180247** ABS Trailer Coil

Voltage: 24

 Cable dim.:  
2x4+3x1.5 mm<sup>2</sup>  
Working length: 4 m

 Plug type: ABS, ABS  
Material: Polyurethan  
Plug 1: 5  
Plug 2: 5  
DIN norm: 74001  
ISO norm: 7638

**7 PIN**
**180194** Trailer Coil

Voltage: 24

 Cable dim.:  
6x1+1x1.5 mm<sup>2</sup>  
Working length: 3.5 m

 Plug type: 12N, 24N, Europe  
Colour: Black  
Material: Nylon  
Windings: 20  
Plug 1: 7  
Plug 2: 7  
ISO norm: 1185  
ISO norm 2: 1724

**180195** Trailer Coil

*Aluminium plug.*

Voltage: 24

 Cable dim.:  
6x1+1x1.5 mm<sup>2</sup>  
Working length: 3.5 m

 Plug type: 24N, Europe, 24N, Europe  
Colour: Black  
Material: Nylon  
Windings: 20  
Plug 1: 7  
Plug 2: 7  
DIN norm: 72579  
ISO norm: 1185

**180196** Trailer Coil

Voltage: 24

 Cable dim.:  
6x1+1x1.5 mm<sup>2</sup>  
Working length: 3.5 m

 Plug type: 24N, Europe, 24N, Europe  
Colour: Black  
Material: Nylon  
Windings: 20  
Plug 1: 7  
Plug 2: 7  
DIN norm: 72579  
ISO norm: 1185

**180226** Trailer Coil

Voltage: 24

 Cable dim.:  
6x1+1x1.5 mm<sup>2</sup>  
Working length: 3.5 m

 Plug type: 24N, Europe, 24N, Europe  
Colour: Black  
Material: Polyurethan  
Windings: 42  
Plug 1: 7  
Plug 2: 7  
ISO norm: 1185

**180227** Trailer Coil

*Aluminium plug.*

Voltage: 24

 Cable dim.:  
6x1+1x1.5 mm<sup>2</sup>  
Working length: 3.5 m

 Plug type: 24N, Europe, 24N, Europe  
Colour: Black  
Material: Polyurethan  
Windings: 42  
Plug 1: 7  
Plug 2: 7  
ISO norm: 1185

**180228** Trailer Coil

Voltage: 24

 Cable dim.:  
6x1+1x1.5 mm<sup>2</sup>  
Working length: 3.5 m

 Plug type: 24N, Europe, 24N, Europe  
Mount.: Moulded  
Colour: Black  
Material: Polyurethan  
Windings: 42  
Plug 1: 7  
Plug 2: 7  
ISO norm: 1185

**180316** Trailer Coil



Voltage: 24

Cable dim.:  
6x1+1x1.5 mm<sup>2</sup>  
Working length: 3.5 m

Plug type: 24S, Europe, 24S, Europe  
Colour: Black  
Material: Polyurethan  
Windings: 42  
Plug 1: 7  
Plug 2: 7  
ISO norm: 3731

**180572** Trailer Coil



Voltage: 24

Cable dim.:  
2x4+5x1.5 mm<sup>2</sup>  
Working length: 4 m

Plug type: EBS, EBS  
Material: Polyurethan  
Plug 1: 7  
Plug 2: 7  
DIN norm: 74001  
ISO norm: 7638

**15 PIN**

**180251** Trailer Coil



Voltage: 24

Cable dim.:  
12x1.5+3x2.5 mm<sup>2</sup>  
Working length: 3.5 m

Material: Polyurethan  
Plug 1: 15  
Plug 2: 15  
ISO norm: 4141  
ISO norm 2: 6772  
ISO norm 3: 12098  
GGVS approval: Yes

**TRAILER PLUGS - 6/24 V**

**3 PIN**

**180401** Plug



Voltage: 6-24  
Amp: max. 20

Connection: Screw

Colour: Black  
Material: Shock thermo plastic  
No./poles: 3  
Male/female: Male  
DIN norm: 9680

**4 PIN**

**180403** Plug



Voltage: 6-24

Connection: Screw

Colour: Black  
Material: Shock thermo plastic  
No./poles: 4  
Male/female: Male  
DIN norm: 72575

**TRAILER PLUGS - 24 V**

**5 PIN**

**180242** ABS Plug

*Incl. tubes 3x1.5+2x4 mm<sup>2</sup> (HC-CARGO 191170).*



Voltage: 24

Connection: Terminal

Plug type: ABS  
Locking device: Metal bracket  
No./poles: 5  
Male/female: Male  
ISO norm: 7638

**181466 ABS Plug**
*Screw connection w/ wirecolour indication.*

Voltage: 24

Connection: Terminal

 Plug type: ABS  
 Locking device: Metal bracket  
 No./poles: 5  
 Male/female: Male  
 ISO norm: 7638

**7 PIN**
**180111 Trailer Plug**

Servicing: HC-CARGO 180112, 180153, 180219, 180607, 180297



Voltage: 24

Connection: Terminal

 Plug type: 24N, Europe  
 Colour: Black  
 Material: Shock thermo plastic  
 No./poles: 7  
 Male/female: Male  
 DIN norm: 72579  
 ISO norm: 1185

**180154 Trailer Plug**

Servicing: HC-CARGO 180112, 180153, 180219, 180607, 180297



Voltage: 24

Connection: Screw

 Plug type: 24N, Europe  
 Colour: Black  
 Material: Shock thermo plastic  
 No./poles: 7  
 Male/female: Male  
 DIN norm: 72579  
 ISO norm: 1185

**180220 Trailer Plug**

Voltage: 24

Connection: Screw

 Plug type: 24N, Europe  
 Material: Cast aluminum  
 No./poles: 7  
 Male/female: Male  
 DIN norm: 72579  
 ISO norm: 1185

**180241 Trailer Plug**

Servicing: HC-CARGO 180568, 180610, 180624

*w/ changed 1/31 contact. w/ grey plastic interior.*

Voltage: 24

Connection: Screw

 Plug type: 24S, Europe  
 Colour: Black  
 Material: Shock thermo plastic  
 No./poles: 7  
 Male/female: Male  
 ISO norm: 3731

**180297 Trailer Plug**

Servicing: HC-CARGO 180296, 180351, 180111, 180154



Voltage: 24

Connection: Terminal

 Plug type: 24N, Europe  
 Material: Cast aluminum  
 No./poles: 7  
 Male/female: Male  
 DIN norm: 72579  
 ISO norm: 1185

**180570 EBS Plug**
*Incl. pins 5x1.5+2x4 mm<sup>2</sup>. w/ locking device.*

Voltage: 24

Connection: Terminal

 Plug type: EBS  
 Locking device: Metal bracket  
 No./poles: 7  
 Male/female: Male  
 DIN norm: 40050  
 ISO norm: 7638  
 Protection degree: Waterproof

<b>180610</b> Trailer Plug <i>w/ changed 1/31 contact. w/ grey plastic interior.</i>		Servicing: HC-CARGO 180240, 180569, 180608, 180241	
	Voltage: 24	Connection: Screw	Plug type: 24S, Europe Colour: Black Material: Shock thermo plastic No./poles: 7 Male/female: Male ISO norm: 3731 Protection degree: IP 54 ADR-approved: Yes
<b>180624</b> Trailer Plug <i>w/ changed 1/31 contact. w/ grey plastic interior.</i>		Servicing: HC-CARGO 180240, 180569, 180608, 180241	
	Voltage: 24	Connection: Screw	Plug type: 24S, Europe Material: Cast aluminum No./poles: 7 Male/female: Male ISO norm: 3731
<b>181469</b> EBS Plug <i>Screw connection w/ wirecolour indication.</i>			
	Voltage: 24	Connection: Terminal	Plug type: EBS Locking device: Metal bracket No./poles: 7 Male/female: Male ISO norm: 7638 Protection degree: Waterproof
<b>13 PIN</b>			
<b>180252</b> EBS Plug <i>Incl. pins 12x1+1x2.5 mm<sup>2</sup>. Weather proof.</i>			
	Voltage: 24	Connection: Terminal	Plug type: EBS No./poles: 13 Male/female: Male DIN norm: 40050 ISO norm: 7638 ADR-approved: Yes GGVS approval: Yes
<b>14 PIN</b>			
<b>180353</b> Trailer Plug <i>For max. 6 mm<sup>2</sup> cable. Socket and plug can be disconnected automatically.</i>		Servicing: HC-CARGO 180352	
	Voltage: 24		Colour: Black Material: Shock thermo plastic No./poles: 14 Male/female: Male
<b>15 PIN</b>			
<b>180285</b> EBS Plug <i>Incl. pins 12x1.5+3x2.5 mm<sup>2</sup>.</i>			
	Voltage: 24	Connection: Terminal	Plug type: EBS No./poles: 15 Male/female: Male DIN norm: 72570 ISO norm: 12098 ADR-approved: Yes GGVS approval: Yes

**181472 EBS Plug 15-Pol**

Voltage: 24

Connection: Screw

 Locking device: Metal bracket  
 No./poles: 15  
 Male/female: Male  
 DIN norm: 72570  
 ISO norm: 12098  
 Protection degree: Waterproof  
 GGVS approval: Yes

**ACCESSORIES**
**180612 Terminal Coupling**

Servicing: HC-CARGO 180296, 180351, 180568, 180111, 180609



Voltage: 24

 Plug type: Europe  
 Colour: Red  
 No./poles: 7

**TRAILER SOCKETS - 6/24 V**
**4 PIN**
**180404 Trailer Socket**

Voltage: 6-24

Connection: Screw

 Colour: Black  
 Material: Shock thermo plastic  
 No./poles: 4  
 Male/female: Female  
 DIN norm: 72575

**TRAILER SOCKETS - 12 V**
**13 PIN**
**181274 Trailer Socket**

Servicing: HC-CARGO 180212

*w/ micro switch, that switch over the rear fog lamps from car to trailer. Trailer socket kit: HC-CARGO 180405 .*

Voltage: 12

Connection: Screw

 Colour: Black  
 Locking device: Bayonet  
 Material: Nickel plated brass  
 No./poles: 13  
 Male/female: Female  
 DIN norm: 72570  
 ISO norm: 11446  
 Protection degree: Splash proof

**TRAILER SOCKETS - 24 V**
**3 PIN**
**180402 Trailer Socket**

Voltage: 6/24

Connection: Screw

 Colour: Black  
 Material: Shock thermo plastic  
 No./poles: 3  
 Male/female: Female

**5 PIN**
**180243 ABS Socket**
*w/ ejector device for correct plug/socket connection. Incl. pins 3x1.5+2x4 mm<sup>2</sup>.*

Voltage: 24

 Plug type: ABS, No./poles: 5  
 Male/female: Female  
 DIN norm: 74001  
 ISO norm: 7638



**181467** ABS Socket

*Screw connection w/ wirecolour indication.*

Voltage: 24

 Plug type: ABS  
 Locking device: Metal bracket  
 No./poles: 5  
 Male/female: Female  
 ISO norm: 7638

**7 PIN**
**180112** Trailer Socket

Servicing: HC-CARGO 180296, 180351, 180111, 180154



Voltage: 24

Connection: Terminal

 Plug type: 24N, Europe  
 Colour: Black  
 Material: Shock thermo plastic  
 No./poles: 7  
 Male/female: Female  
 DIN norm: 72579  
 ISO norm: 1185

**180153** Trailer Socket

Servicing: HC-CARGO 180296, 180351, 180111, 180154



Voltage: 24

Connection: Screw

 Plug type: 24N, Europe  
 Colour: Black  
 Material: Shock thermo plastic  
 No./poles: 7  
 Male/female: Female  
 DIN norm: 72579  
 ISO norm: 1185

**180219** Trailer Socket

Servicing: HC-CARGO 180296, 180351, 180111, 180154



Voltage: 24

Connection: Screw

 Plug type: 24N, Europe  
 Material: Cast aluminum  
 No./poles: 7  
 Male/female: Female  
 DIN norm: 72579  
 ISO norm: 1185

**180240** Trailer Socket

Servicing: HC-CARGO 180568, 180610, 180624

*w/ changed 1/31 contact. w/ grey cap.*

Voltage: 24

Connection: Screw

 Plug type: 24S, Europe  
 Colour: Black  
 Material: Shock thermo plastic  
 No./poles: 7  
 Male/female: Female  
 ISO norm: 3731

**180296** Trailer Socket

Servicing: HC-CARGO 180112, 180153, 180219, 180607, 180297



Voltage: 24

Connection: Terminal

 Plug type: 24N, Europe  
 Material: Cast aluminum  
 No./poles: 7  
 Male/female: Female  
 DIN norm: 72579  
 ISO norm: 1185

**180351** Trailer Socket

Servicing: HC-CARGO 180112, 180153, 180219, 180607, 180297

*16x flat tongue.*

Voltage: 24

Connection: Terminal

 Plug type: 24N, Europe  
 Material: Cast aluminum  
 No./poles: 7  
 Male/female: Female  
 DIN norm: 72579  
 ISO norm: 1185

EL. SPECIFICATIONS		DIMENSIONS	ADDITIONAL SPECIFICATIONS
<b>180568 Trailer Socket</b>			
Servicing: HC-CARGO 180240, 180569, 180608, 180241			
<i>w/ changed 1/31 contact. w/ grey cap.</i>			
	Voltage: 24	Connection: Terminal	Plug type: 24S, Europe Colour: Black Material: Shock thermo plastic No./poles: 7 Male/female: Female ISO norm: 3731
<b>180569 Trailer Socket</b>			
Servicing: HC-CARGO 180568, 180610, 180624			
<i>w/ changed 1/31 contact. w/ grey cap.</i>			
	Voltage: 24	Connection: Terminal	Plug type: 24S, Europe Material: Cast aluminum No./poles: 7 Male/female: Female ISO norm: 3731
<b>180571 EBS Socket</b>			
<i>w/ ejector device for correct plug/socket connection. Incl. pins 3x1.5+2x4 mm<sup>2</sup>.</i>			
	Voltage: 24	Connection: Terminal	Plug type: EBS No./poles: 7 Male/female: Female DIN norm: 74001 ISO norm: 7638
<b>180607 Trailer Socket</b>			
Servicing: HC-CARGO 180296, 180351, 180111, 180154			
	Voltage: 24	Connection: Terminal	Plug type: 24N, Europe No./poles: 7 Male/female: Female DIN norm: 72579 ISO norm: 1185 Protection degree: IP 54 ADR-approved: Yes
<b>180608 Trailer Socket</b>			
Servicing: HC-CARGO 180568, 180610, 180624			
<i>w/ changed 1/31 contact. w/ grey cap.</i>			
	Voltage: 24	Connection: Terminal	Plug type: 24S, Europe Colour: Black Material: Shock thermo plastic No./poles: 7 Male/female: Female ISO norm: 3731 Protection degree: IP 54 ADR-approved: Yes
<b>181470 EBS Socket</b>			
<i>Screw connection w/ wirecolour indication.</i>			
	Voltage: 24		Plug type: EBS Locking device: Metal bracket No./poles: 7 Male/female: Female ISO norm: 7638
<b>181471 EBS Socket</b>			
<i>Screw connection w/wire colour indication. Angled.</i>			
	Voltage: 24		Plug type: EBS Locking device: Bayonet No./poles: 7 ISO norm: 7638

## 13 PIN

### 180253 EBS Socket

*Incl. pins 12x1+1x2.5 mm<sup>2</sup>. Weather proof.*



Voltage: 24

Plug type: EBS  
No./poles: 13  
Male/female: Female  
DIN norm: 74001  
ISO norm: 12098  
ADR-approved: Yes  
GGVS approval: Yes

## 14 PIN

### 180352 Trailer Socket

Servicing: HC-CARGO 180353

*For max. 6 mm<sup>2</sup> cable. Socket and plug can be disconnected automatically.*



Voltage: 24

Colour: Black  
Material: Shock thermo plastic  
No./poles: 14  
Male/female: Female

## 15 PIN

### 180286 EBS Socket

*w/ locking device preventing accidental disengagement. Incl. terminals 10x1.5+2x1+3x2.5 mm<sup>2</sup>.*



Voltage: 24

Plug type: EBS  
No./poles: 15  
Male/female: Female  
DIN norm: 72570  
ISO norm: 12098  
ADR-approved: Yes  
GGVS approval: Yes

### 181473 EBS Socket



Voltage: 24

Connection: Screw

Locking device: Metal bracket  
No./poles: 15  
Male/female: Female  
DIN norm: 72570  
ISO norm: 12098  
Protection degree: Waterproof  
ADR-approved: Yes  
GGVS approval: Yes

### 181474 EBS Socket



Voltage: 24

Connection: Screw

Locking device: Bayonet  
No./poles: 15  
Male/female: Female  
DIN norm: 72570  
ISO norm: 12098  
Protection degree: Waterproof  
ADR-approved: Yes  
GGVS approval: Yes

## ACCESSORIES

### 180611 Terminal Coupling

Servicing: HC-CARGO 180112, 180569, 180607, 180608, 180241, 180297

*For trailer sockets.*



Voltage: 24

Plug type: Europe  
Colour: White  
No./poles: 7  
Male/female: Multiplug

## RELAY & SWITCHES

### CIRCUIT BREAKERS

#### PANEL MOUNT TYPE

**192959** Circuit Breaker Servicing: Motors, transformers, battery chargers, machinery, extra low voltage systems

*Circuit breaker w/ thread neck for panel mounting. Mounting hole 9.6 mm.*



Voltage: Multi  
Amp: 5

Length: 79.4 mm

Type: Thermo contact  
Plug type: Flat

**192960** Circuit Breaker Servicing: Motors, transformers, battery chargers, machinery, extra low voltage systems

*Circuit breaker w/ thread neck for panel mounting. Mounting hole 9.6 mm.*



Voltage: Multi  
Amp: 7

Length: 79.4 mm

Type: Thermo contact  
Plug type: Flat

**192961** Circuit Breaker Servicing: Motors, transformers, battery chargers, machinery, extra low voltage systems

*Circuit breaker w/ thread neck for panel mounting. Mounting hole 9.6 mm.*



Voltage: Multi  
Amp: 10

Length: 79.4 mm

Type: Thermo contact  
Plug type: Flat

**192962** Circuit Breaker Servicing: Motors, transformers, battery chargers, machinery, extra low voltage systems

*Circuit breaker w/ thread neck for panel mounting. Mounting hole 9.6 mm.*



Voltage: Multi  
Amp: 15

Length: 79.4 mm

Type: Thermo contact  
Plug type: Flat

**192963** Circuit Breaker Servicing: Motors, transformers, battery chargers, machinery, extra low voltage systems

*Circuit breaker w/ thread neck for panel mounting. Mounting hole 9.6 mm.*



Voltage: Multi  
Amp: 20

Length: 79.4 mm

Type: Thermo contact  
Plug type: Flat

**192964** Circuit Breaker Servicing: Motors, transformers, battery chargers, machinery, extra low voltage systems

*Circuit breaker w/ thread neck for panel mounting. Mounting hole 9.6 mm.*



Voltage: Multi  
Amp: 25

Length: 79.4 mm

Type: Thermo contact  
Plug type: Flat

**RELAYS**

**CHANGE OVER - 24 V**

**160216 Relay**



Voltage: 24  
Amp: 20/10

Type: Change Over  
Terminals: 5  
Bracket: w/

**160271 Relay**

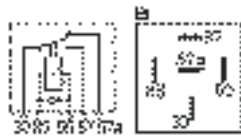

Voltage: 24  
Amp: 20/10

Type: Change Over  
Terminals: 5  
Bracket: w/  
Diode: w/

**160317 Relay**

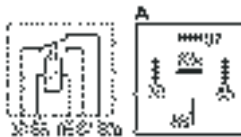

Voltage: 24  
Amp: 22/10

Type: Change Over  
Terminals: 5  
Bracket: w/

**160337 Relay**

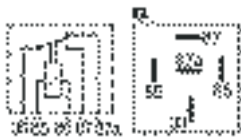

Voltage: 24  
Amp: 22/10

Type: Change Over  
Terminals: 5

**160368 Micro Relay**



Voltage: 24  
Amp: 20/10

Type: Change Over  
Terminals: 5

**160394 Relay**

Servicing: Mercedes, Iveco, Audi



Voltage: 24  
Amp: 60/40

Type: Change Over  
Terminals: 5  
Resistor: w/

**160521 Micro Relay**



Voltage: 24  
Amp: 20/10

Type: Change Over  
Terminals: 5  
Diode: w/

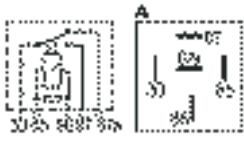

**160944 Relay**

 Voltage: 24  
Amp: 10/20

 Type: Change Over  
Terminals: 5  
Resistor: w/

**160976 Relay**

 Voltage: 24  
Amp: 50/30

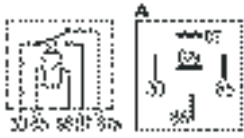
 Type: Change Over  
Terminals: 2x6.3 mm, 3x9.5 mm

**160980 Relay**

 Voltage: 24  
Amp: 30/40

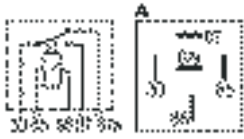
 Type: Change Over  
Terminals: 2x6.3 mm, 3x9.5 mm  
Bracket: w/

**160981 Relay**

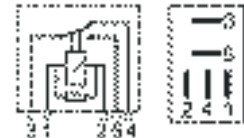
 Voltage: 24  
Amp: 10/20

 Type: Change Over  
Terminals: 5  
Bracket: w/

**161010 Micro Relay**

 Voltage: 24  
Amp: 20/10

 Type: Change Over  
Terminals: 5  
Resistor: w/

**161020 Micro Relay**

 Voltage: 24  
Amp: 15/10

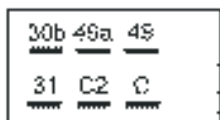
 Type: Change Over  
Terminals: 5  
Diode: w/

**FLASHER UNITS - 24 V**
**160199 Flasher Unit**

Servicing: Mazda, Volvo

 Voltage: 24  
Watt: 3+1/8x21

Terminals: 6

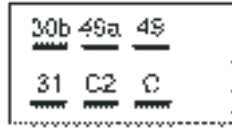
**160262** Flasher Unit

 Voltage: 24  
 Watt: 2+1/6x21

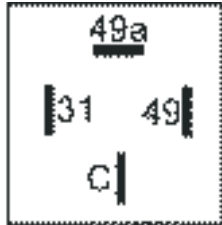
 Terminals: 6  
 Bracket: w/

**160296** Flasher Unit

 Voltage: 24  
 Watt: 2/4x21

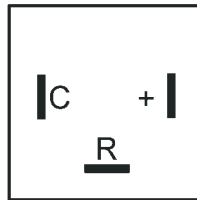
 Terminals: 4  
 Bracket: w/

**160313** Flasher Unit

*Interchangeable w/ all 4 terminal device (+, -, C, R). for SAE standard vehicles (France, Italy, USA, Spain).*

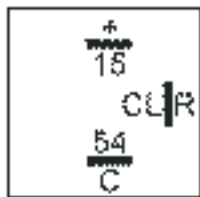
 Voltage: 24  
 Watt: 2/4x21

 Terminals: 3  
 Bracket: w/

**160716** Flasher Unit

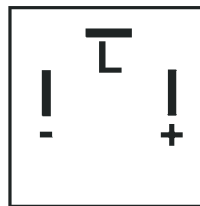
 Voltage: 24  
 Watt: 500

 Plug type: Flat  
 Terminals: 3  
 Bracket: w/

**160952** Flasher Unit

 Voltage: 24  
 Watt: 0.1-150

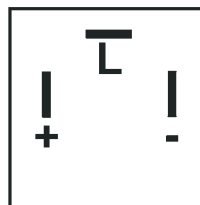
Height: 30 mm

 Plug type: Flat  
 Terminals: 3

**160953** Flasher Unit

 Voltage: 24  
 Watt: 0.1-150

Height: 30 mm

 Plug type: Flat  
 Terminals: 3

**160955** i-LS Sensor

*In combination w/ an I-LS flasher unit, the I-LS sensor secures the legal requirements of "lamp failure warning".*



Voltage: 24

Terminals: 3

**160958** Flasher Unit i-LS

Servicing: Vehicles w/ 2 LED lamps on front or rear

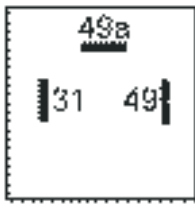
In combination w/ an I-LS sensor, the I-LS flasher relay secures the legal requirements of "lamp failure warning" by installed LED lamps.



Voltage: 24  
Watt: 90

Terminals: 3  
Bracket: w/

**160959** Flasher Unit i-LS

Servicing: Vehicles w/ trailer, w/ 2 LED lamps

In combination w/ an I-LS sensor, the I-LS flasher relay secures the legal requirements of "lamp failure warning" by installed LED lamps.

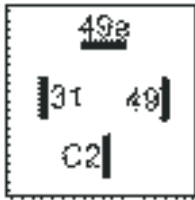

Voltage: 24  
Watt: 170

Terminals: 4  
Bracket: w/

**MULTITIMER**

**160928** Multitimer Relay

0.5 sec. -6 hours.

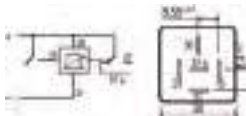

Voltage: 24  
Amp: 10

Terminals: 5

**TIME DELAY - 24 V**

**160466** Time Delay Relay

For A/C compressor, bus doors and time delayed motors.

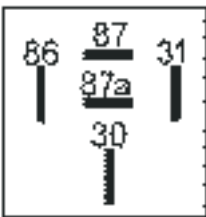

Voltage: 24  
Amp: 5

Delay time: 4 sec

Terminals: 5

**WORK RELAYS**

**160082** Mini Relay



Voltage: 24  
Amp: 20

Terminals: 4  
Bracket: w/

**160169** Relay



Voltage: 24  
Amp: 2x10

Terminals: 5  
Bracket: w/

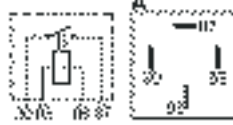
**160215 Mini Relay**

 Voltage: 24  
 Amp: 20

Terminals: 4

**160240 Mini Relay**
*w/ two 6.3 mm and two 9.5 mm terminals. (terminals 30 and 87).*

 Voltage: 24  
 Amp: 40

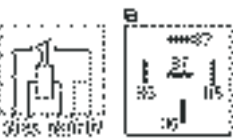
 Type: High performance  
 Terminals: 4

**160266 Mini Relay**

 Voltage: 24  
 Amp: 20

 Terminals: 5  
 Bracket: w/

**160272 Mini Relay**
*w/ two 6.3 mm and two 9.5 mm terminals. (terminals 30 and 87).*

 Voltage: 24  
 Amp: 70

 Type: High performance  
 Terminals: 4  
 Resistor: w/

**160307 Mini Relay**

 Voltage: 24  
 Amp: 20

Terminals: 4

**160473 Mini Relay**

 Voltage: 24  
 Amp: 30

 Type/fuse: ATO  
 Terminals: 4  
 Bracket: w/  
 Fuse incl.: Yes  
 Fuse incl.: Yes

**160478 Mini Relay**
*180 A for 15 sec. w/ 2x6.3 mm screws and 2xM6 flat plugs.*

 Voltage: 24  
 Amp: 60

 Type: High performance  
 Terminals: 4  
 Bracket: w/

**160721 Mini Relay**

 Voltage: 24  
Amp: 100

 Type: High performance  
Terminals: 4  
Bracket: w/

**160769 Mini Relay**
*w/ two 6.3 mm and two 9.5 mm terminals. (terminals 30 and 87).*

 Voltage: 24  
Amp: 70

 Type: High performance  
Terminals: 4

**160890 Mini Relay**

 Voltage: 24  
Amp: 20

 Terminals: 4  
Bracket: w/  
Diode: w/

**160926 Mini Relay**

 Voltage: 24  
Amp: 15

 Type/fuse: ATO  
Terminals: 4  
Bracket: w/  
Fuse incl.: Yes  
Fuse incl.: Yes

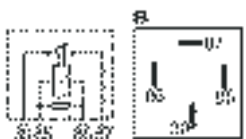
**160935 Mini Relay**

 Voltage: 24  
Amp: 22

 Terminals: 4  
Bracket: w/  
Resistor: w/

**160936 Mini Relay**
*w/ double output.*

 Voltage: 24  
Amp: 22

 Terminals: 5  
Bracket: w/

**160937 Mini Relay**

 Voltage: 24  
Amp: 40

 Type: High performance  
Terminals: 4  
Bracket: w/

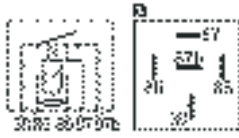

**160938 Relay**
*w/ double contact.*

 Voltage: 24  
 Amp: 2x10

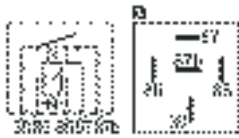
 Terminals: 5  
 Bracket: w/  
 Resistor: w/

**160939 Relay**

 Voltage: 24  
 Amp: 2x10

 Terminals: 5  
 Bracket: w/  
 Diode: w/

**160947 Mini Relay**

 Voltage: 24  
 Amp: 30

 Terminals: 4  
 Bracket: w/  
 Diode: w/

**160975 Mini Relay**
*w/ two 6.3 mm and two 9.5 mm terminals. (terminals 30 and 87).*

 Voltage: 24  
 Amp: 70

 Type: High performance  
 Terminals: 4  
 Bracket: w/

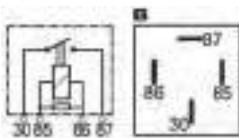
**160977 Mini Relay**
*w/ two 6.3 mm and two 9.5 mm terminals. (terminals 30 and 87).*

 Voltage: 24  
 Amp: 50

 Type: High performance  
 Terminals: 4  
 Bracket: w/  
 Resistor: w/

**160978 Mini Relay**
*w/ two 6.3 mm and two 9.5 mm terminals. (terminals 30 and 87).*

 Voltage: 24  
 Amp: 40

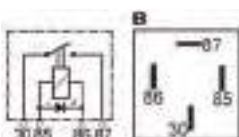
 Type: High performance  
 Terminals: 4

**160979 Mini Relay**

 Voltage: 24  
 Amp: 30

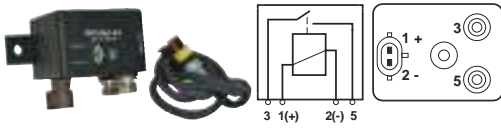
 Type: High performance  
 Terminals: 4  
 Bracket: w/  
 Diode: w/

**160985 Relay**
*ADR-approved*

 Voltage: 24  
Amp: 200

 Type: High performance  
Terminals: 3  
Bracket: w/

**161035 Mini Relay**

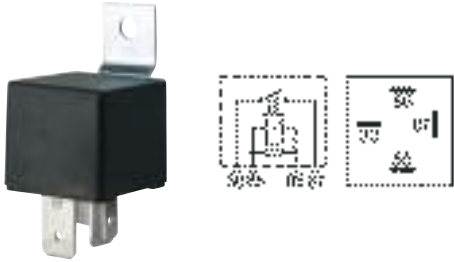
Servicing: Scania

 Voltage: 24  
Amp: 70

 Type: High performance  
Terminals: 4  
Bracket: w/  
Resistor: w/

**SWITCHES**
**MINI ROCKER**
**180597 Mini Rocker Switch**

 Voltage: 12/24  
Amp: 20/10

 Mount. hole size:  
21 mm

 Switch: On/Off  
Terminals: 2

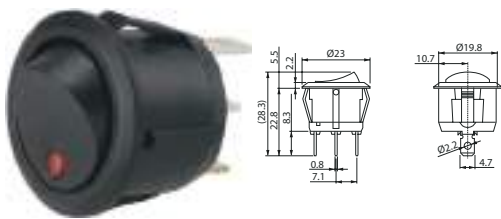
**181607 Mini Rocker Switch**

 Voltage: 24  
Amp: 10

 Mount. hole size:  
21 mm

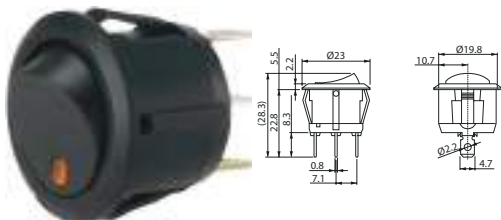
 Type/terminal: Flat  
Button colour: Red  
Switch: On/Off  
Terminals: 3  
Bulb: LED  
Illuminated: Yes

**181608 Mini Rocker Switch**

 Voltage: 24  
Amp: 10

 Mount. hole size:  
20 mm

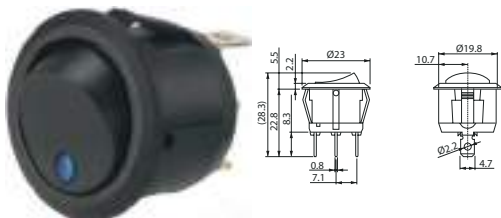
 Type/terminal: Flat  
Button colour: Orange  
Switch: On/Off  
Terminals: 3  
Bulb: LED  
Illuminated: Yes

**181609 Mini Rocker Switch**

 Voltage: 24  
Amp: 10

 Mount. hole size:  
20 mm

 Type/terminal: Flat  
Button colour: Blue  
Switch: On/Off  
Terminals: 3  
Bulb: LED  
Illuminated: Yes

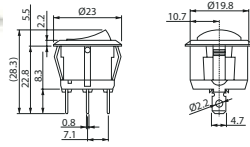
**181610** Mini Rocker Switch



Voltage: 24  
Amp: 10

Mount. hole size:  
20 mm

Type/terminal: Flat  
Button colour: Green  
Switch: On/Off  
Terminals: 3  
Bulb: LED  
Illuminated: Yes

**MULTI PURPOSE**

**181249** Push Switch

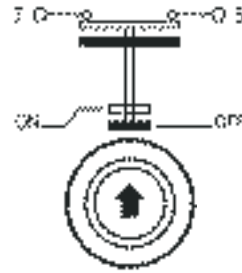

Voltage: 12/24  
Amp: 50/25

Mount. hole size:  
30.5 mm

Button symbol: Lift & lower  
Switch: Off/(On)  
No./terminals w/screw: 2  
DIN norm: 40053  
Protection degree: IP 67

**181251** Push Switch



Voltage: 12/24  
Amp: 50/25

Mount. hole size:  
30.5 mm

Button symbol: Rotating beacon  
Switch: On/Off  
No./terminals w/screw: 6  
Illuminated: Yes  
DIN norm: 40053  
Protection degree: IP 67

**181252** Push Switch

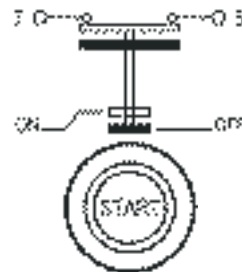

Voltage: 12/24  
Amp: 50/25

Mount. hole size:  
30.5 mm

Button symbol: Start  
Switch: Off/(On)  
No./terminals w/screw: 2  
DIN norm: 40053  
Protection degree: IP 67

**181253** Push Switch

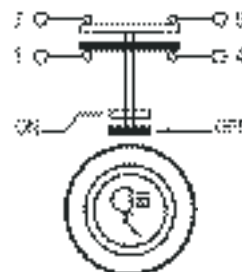

Voltage: 12/24  
Amp: 50/25

Mount. hole size:  
30.5 mm

Button symbol: Adjustable light  
Switch: On/Off  
No./terminals w/screw: 4  
Illuminated: Yes  
DIN norm: 40053  
Protection degree: IP 67

**181256** Push Switch



Voltage: 12/24  
Amp: 50/25

Mount. hole size:  
30.5 mm

Button symbol: Hazard Warning Lamp  
Switch: On/Off  
No./terminals w/screw: 7  
Illuminated: Yes  
Automatic return: Yes  
DIN norm: 40053  
Protection degree: IP 67

**181257** Push Switch



Voltage: 12/24  
Amp: 50/25

Mount. hole size:  
30.5 mm

Button symbol: Sidemarker  
Switch: On/Off  
No./terminals w/screw: 4  
Illuminated: Yes  
DIN norm: 40053  
Protection degree: IP 67

**181258** Push Switch

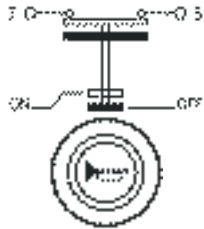

Voltage: 12/24  
Amp: 50/25

Mount. hole size:  
30.5 mm

Button symbol: Horn  
Switch: Off/(On)  
No./terminals w/screw: 2  
DIN norm: 40053  
Protection degree: IP 67

**181263** Push Switch



Voltage: 12/24  
Amp: 50/25

Mount. hole size:  
30.5 mm

Switch: On/Off  
No./terminals w/screw: 6  
Illuminated: Yes  
Automatic return: Yes  
DIN norm: 40053  
Protection degree: IP 67

**181264** Multi Socket

Servicing: Renault

For multi purpose switches.



Type/terminal: Flat  
No./poles: 7

**PUSH-PULL**

**180021** Push/Pull Switch

Max. 3 W BA 7 bulb.



Voltage: 12/24  
Amp: 6/3

Mount. hole size:  
12.5 mm

Type/terminal: Flat  
Button colour: Orange  
Switch: On/Off  
Terminals: 2  
Illuminated: Yes  
Bulb incl.: No

**180022** Push/Pull Switch

Max. 3 W BA 7 bulb.



Voltage: 12/24  
Amp: 6/3

Mount. hole size:  
12.5 mm

Type/terminal: Terminal  
Button colour: Green  
Switch: On/Off  
Terminals: 2  
Illuminated: Yes  
Bulb incl.: No

**180023** Push/Pull Switch

Max. 3 W BA 7 bulb.



Voltage: 12/24  
Amp: 6/3

Mount. hole size:  
12.5 mm

Type/terminal: Terminal  
Button colour: Red  
Switch: On/Off  
Terminals: 2  
Illuminated: Yes  
Bulb incl.: No

**180103** Push/Pull Switch

 Voltage: 12/24  
 Amp: 25/12.5

 Neck: Short  
 Mount. hole size:  
 8 mm

 Type/terminal: Screw  
 Button colour: Black  
 Switch: On/Off  
 No./terminals w/screw: 2  
 Illuminated: No

**180104** Push/Pull Switch

 Voltage: 12/24  
 Amp: 25/12.5

 Neck: Long  
 Mount. hole size:  
 8 mm

 Button colour: Black  
 Switch: On/Off  
 No./terminals w/screw: 2

**181233** Push/Pull Switch

 Voltage: 12/24  
 Amp: 25/12.5

 Neck: Short  
 Mount. hole size:  
 8 mm

 Type/terminal: Flat  
 Button colour: Black  
 Switch: On/Off  
 Terminals: 2

**PUSH-PUSH**
**180123** On/Off Switch

Voltage: 12/24

 Mount. hole size:  
 8 mm

 Button colour: White  
 Switch: On/Off  
 No./terminals w/screw: 2

**181564** Push Button Switch

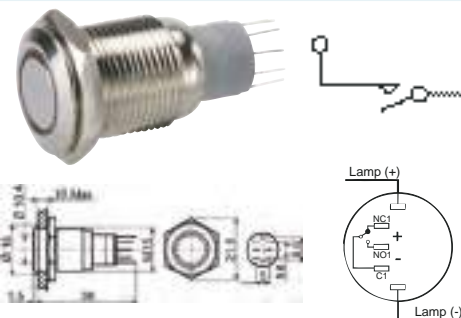
*Illuminated ring. Vandal proof.*

 Voltage: 12/24  
 Amp: <2  
 Voltage 2: 250  
 Amp 2: 3

 Mount. hole size:  
 16 mm

 Type/terminal: Solder  
 Socket type: LED  
 Colour: Red  
 Switch: On/Off  
 Material: Nickel plated brass  
 Moulded: No  
 Silver contact: Yes  
 Protection degree: IP 67

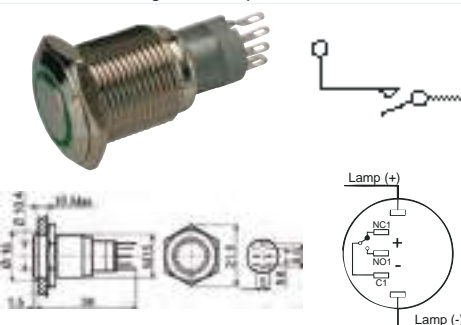
**181565** Push Button Switch

*Illuminated ring. Vandal proof.*

 Voltage: 12/24  
 Amp: <2  
 Voltage 2: 250  
 Amp 2: 3

 Mount. hole size:  
 16 mm

 Type/terminal: Solder  
 Socket type: LED  
 Button colour: Green  
 Switch: On/Off  
 Material: Nickel plated brass  
 Moulded: No  
 Silver contact: Yes  
 Protection degree: IP 67



**181566 Push Button Switch**

*Illuminated ring. Vandal proof.*

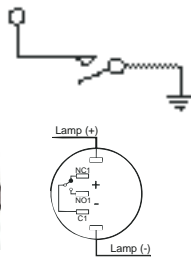
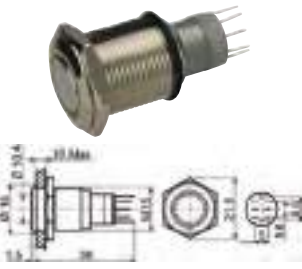

Voltage: 12/24  
Amp: <2  
Voltage 2: 250  
Amp 2: 3

Mount. hole size:  
16 mm

Type/terminal: Solder  
Socket type: LED  
Button colour: Yellow  
Switch: On/Off  
Material: Nickel plated brass  
Moulded: No  
Silver contact: Yes  
Protection degree: IP 67

**181567 Push Button Switch**

*Illuminated ring. Vandal proof.*

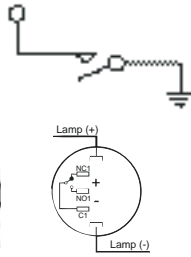
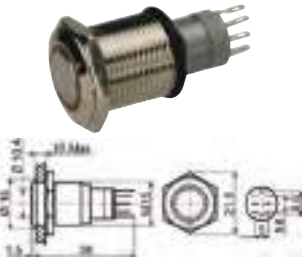

Voltage: 12/24  
Amp: <2  
Voltage 2: 250  
Amp 2: 3

Mount. hole size:  
16 mm

Type/terminal: Solder  
Socket type: LED  
Button colour: Orange  
Switch: On/Off  
Material: Nickel plated brass  
Moulded: No  
Silver contact: Yes  
Protection degree: IP 67

**181568 Push Button Switch**

*Illuminated ring. Vandal proof.*

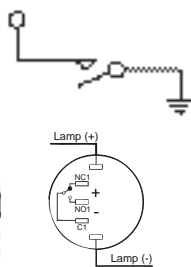
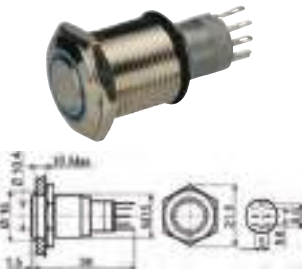

Voltage: 12/24  
Amp: <2  
Voltage 2: 250  
Amp 2: 3

Mount. hole size:  
16 mm

Type/terminal: Solder  
Socket type: LED  
Button colour: Blue  
Switch: On/Off  
Material: Nickel plated brass  
Moulded: No  
Silver contact: Yes  
Protection degree: IP 67

**181569 Push Button Switch**

*Illuminated ring. Vandal proof.*

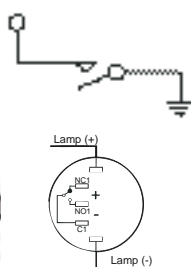
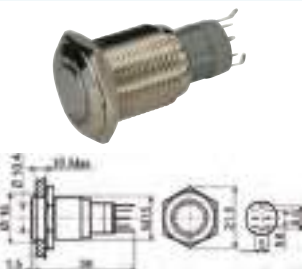

Voltage: 12/24  
Amp: <2  
Voltage 2: 250  
Amp 2: 3

Mount. hole size:  
16 mm

Type/terminal: Solder  
Socket type: LED  
Colour: White  
Button colour: Blank  
Switch: On/Off  
Material: Nickel plated brass  
Moulded: No  
Silver contact: Yes  
Protection degree: IP 67

**ROCKER**

**180090 Rocker Switch**



Voltage: 12/24  
Amp: 16/8

Mount. hole size:  
28.5x11.5 mm

Switch: On/Off  
No./terminals w/screw: 2









**180176 Rocker Switch**

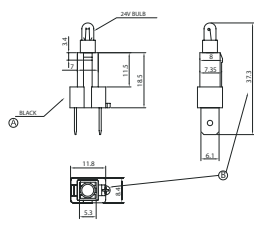

Voltage: 12/24  
Amp: 10/5

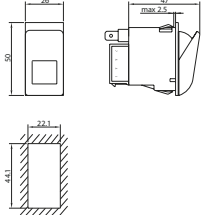
Mount. hole size:  
12.5 mm

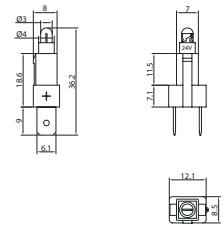
Switch: On/Off  
Terminals: 2

<b>180207</b> Rocker Switch <i>w/o symbol plate. Illuminated w/ location and function light. Bulb: HC-CARGO 181632, 181668 (LED).</i>		Servicing: HC-CARGO 180208	
	Voltage: 24 Amp: 8 Watt: 1.2	Mount. hole size: 22.1x44.1 mm	Socket type: T5 Switch: On/Off No./terminals w/screw: 4 Illuminated: Yes Bulb incl.: Yes
<b>181546</b> Rocker Switch <i>w/o symbol plate. Illuminated w/ location and function light. Bulb: HC-CARGO 181615, 181667 (LED), 181632, 181668 (LED).</i>		Servicing: HC-CARGO 180208	
	Voltage: 12/24	Mount. hole size: 22.1x44.1 mm	Type/terminal: Flat Switch: (On)/Off/(On) Terminals: 6 Bulb incl.: No Automatic return: Yes
<b>181632</b> Bulb Holder 24 V		Servicing: HC-CARGO 180207, 181546, 181639, 181640	
 	Voltage: 24		
<b>181639</b> Rocker Switch <i>w/o symbol plate. Illuminated w/ location and function light. Bulb: HC-CARGO 181632, 181668 (LED).</i>		Servicing: HC-CARGO 180207, 181546, 181639, 181640	
 	Voltage: 24 Amp: 8 Watt: 1.2	Mount. hole size: 22.1x44.1 mm	Socket type: T5 Switch: On/Off No./terminals w/screw: 4 Bulb incl.: Yes Automatic return: Yes
<b>181640</b> Rocker Switch <i>w/o symbol plate. Illuminated w/ location and function light. Bulb: HC-CARGO 181615, 181667 (LED), 181632, 181668 (LED).</i>		Servicing: HC-CARGO 180207, 181546, 181639, 181640	
	Voltage: 12/24	Mount. hole size: 22.1x44.1 mm	Type/terminal: Flat Switch: (On)/Off/(On) Terminals: 6 Bulb incl.: No Automatic return: Yes
<b>181668</b> Bulb Holder 24 V LED		Servicing: HC-CARGO 180207, 181546, 181639, 181640	
 	Voltage: 24		
<b>211123</b> Rocker Switch <i>w/o symbol plate. Illuminated w/ location and function light. Bulb: HC-CARGO 211083, 211097.</i>		Servicing: HC-CARGO 211083, 211097	
	Voltage: 12/24		Type/terminal: Flat Terminals: 3

**ROTATING**
**180007** 3-Way Switch

 Voltage: 12/24  
Watt: 3

 Mount. hole size:  
26 mm

 Socket type: BA7s  
Button colour: Black  
Switch: On/Off/On  
Terminals: 7  
Illuminated: Yes  
Bulb incl.: No

**180158** Rotating Switch

*For light, fan etc.*

 Voltage: 12/24  
Amp: 15/7.5

 Mount. hole size:  
12.5 mm  
Positions: 0-1-2-3

 Button colour: Black  
Terminals: 5  
Protection degree: IP 53

**180314** Rotating Switch

*w/ blower symbol.*

 Voltage: 12/24  
Amp: 15/7.5

 Mount. hole size:  
12.5 mm  
Positions: 0-1-2

 Button colour: Black  
Button symbol: Blower  
Terminals: 3  
Protection degree: IP 53

**SPARE KEYS**
**180339** Spare Key

Servicing: HC-CARGO 180025, 180027, 180043, 181518

**180340** Spare Key

Servicing: HC-CARGO 180041, 180044

**180341** Spare Key







Servicing: HC-CARGO 180045, 180324

**181465** Spare Key

Servicing: HC-CARGO 181235, 181236, 181237



Material: Metal

TOGGLE			
<b>180018 Toggle Switch</b>			
	Voltage: 12/24 Amp: 10/5	Mount. hole size: 12.5 mm	Colour: Black Switch: On/Off Terminals: 2 Arm: Long
<b>180036 3-Way Switch</b>			
	Voltage: 12/24 Amp: 16/8	Mount. hole size: 12.5 mm	Button colour: Black Switch: On/Off/On Terminals: 3
<b>180039 3-Way Switch</b>			
<i>For steering column of 35-40 mm.</i>			
	Voltage: 12/24 Amp: 16/8 Watt: 1.5		Socket type: T-1 1/2 Button colour: Green Bulb: T 1 1/2 Midget Illuminated: Yes Bulb incl.: Yes
<b>180088 Toggle Switch</b>			
	Voltage: 12/24 Amp: 16/8	Mount. hole size: 12.5 mm	Colour: Black Switch: Off/(On) Terminals: 2 Arm: Short
<b>180140 Toggle Switch</b>			
	Voltage: 12/24 Amp: 10/5	Mount. hole size: 12.5 mm	Colour: Black Switch: On/Off Terminals: 2 Arm: Short
<b>180141 Toggle Switch</b>			
	Voltage: 12/24 Amp: 5/2.5	Mount. hole size: 12.5 mm	Colour: Black Switch: On/On Terminals: 3 Arm: Short 2 poles: w/
<b>180584 Toggle Switch</b>			
<i>Rubber Boot: HC-CARGO 181672.</i>			
	Voltage: 12/24 Amp: 16/8	Mount. hole size: 12 mm	Switch: On/Off Material: Metal Terminals: 2 Arm: Short

**180585 Toggle Switch**
*Rubber Boot: HC-CARGO 180595.*

 Voltage: 12/24  
Amp: 16/8

 Mount. hole size:  
12 mm

 Switch: On/(On)  
Material: Metal  
Terminals: 3  
Arm: Short

**180586 Toggle Switch**
*Rubber Boot: HC-CARGO 180595.*

 Voltage: 12/24  
Amp: 16/8

 Mount. hole size:  
12 mm

 Switch: On/On  
Material: Metal  
Terminals: 3  
Arm: Short

**180587 Toggle Switch**
*Rubber Boot: HC-CARGO 181672.*

 Voltage: 12/24  
Amp: 16/8

 Mount. hole size:  
12 mm

 Switch: (On)/Off/(On)  
Material: Metal  
Terminals: 3  
Arm: Short

**180588 Toggle Switch**

Servicing: Ford

*Rubber Boot: HC-CARGO 180595.*

 Voltage: 12/24  
Amp: 16/8

 Mount. hole size:  
12 mm

 Switch: On/Off/(On)  
Material: Metal  
Terminals: 3  
Arm: Short

**180589 Toggle Switch**
*Rubber Boot: HC-CARGO 180595.*

 Voltage: 12/24  
Amp: 16/8

 Mount. hole size:  
12 mm

 Switch: On/Off/On  
Material: Metal  
Terminals: 3  
Arm: Short

**180590 Toggle Switch**
*Rubber Boot: HC-CARGO 181672.*

 Voltage: 12/24  
Amp: 16/8

 Mount. hole size:  
12 mm

 Switch: On/Off  
Material: Metal  
Terminals: 4  
Arm: Short  
2 poles: w/

**180591 Toggle Switch**
*Rubber Boot: HC-CARGO 181672.*

 Voltage: 12/24  
Amp: 16/8

 Mount. hole size:  
12 mm

 Switch: On/On  
Material: Metal  
Terminals: 6  
Arm: Short  
2 poles: w/



**180592 Toggle Switch**

Rubber Boot: HC-CARGO 181672.



Voltage: 12/24  
Amp: 16/8

Mount. hole size:  
12 mm

Switch: (On)/Off/(On)  
Material: Metal  
Terminals: 6  
Arm: Short  
2 poles: w/

**180593 Toggle Switch**

Rubber Boot: HC-CARGO 181672.



Voltage: 12/24  
Amp: 16/8

Mount. hole size:  
12 mm

Switch: On/Off/(On)  
Material: Metal  
Terminals: 6  
Arm: Short  
2 poles: w/

**180594 Toggle Switch**

Rubber Boot: HC-CARGO 181672.



Voltage: 12/24  
Amp: 16/8

Mount. hole size:  
12 mm

Switch: On/Off/On  
Material: Metal  
Terminals: 6  
Arm: Short  
2 poles: w/

**180618 Toggle Switch**



Voltage: 12/24  
Amp: 6/3

Mount. hole size:  
12 mm

Switch: (On)/Off/(On)  
Material: Metal  
Terminals: 3  
Arm: Long

**181276 Mini Toggle Switch**

Mini.



Voltage: 12/24  
Amp: 6/3

Mount. hole size:  
6 mm

Switch: On/Off  
Material: Metal  
Terminals: 2  
Arm: Short

**181277 Mini Toggle Switch**

Mini.



Voltage: 12/24  
Amp: 6/3

Mount. hole size:  
6 mm

Switch: On/On  
Material: Metal  
Terminals: 3  
Arm: Short

**181278 Mini Toggle Switch**



Voltage: 12/24  
Amp: 6/3

Mount. hole size:  
6 mm

Switch: On/Off/On  
Material: Metal  
Terminals: 3  
Arm: Short

**PUSH BUTTON**
**180040** Push Button Switch

*Rubber moulded boot on front.*

 Voltage: 12/24  
Amp: 25/12.5

 Mount. hole size:  
22.5 mm

 Switch: Off/(On)  
No./terminals w/screw: 2  
Moulded: Yes  
DIN norm: 72764

**180047** Push Button Switch

Voltage: 12/24

 Mount. hole size:  
12.5 mm

 Button colour: Black  
Switch: Off/(On)  
No./terminals w/screw: 1

**180049** Push Button Switch

 Voltage: 12/24  
Amp: 25/12.5

 Mount. hole size:  
22.5 mm

 Button colour: Black  
Switch: Off/(On)  
No./terminals w/screw: 2  
DIN norm: 72764

**180121** Push Button Switch

 Voltage: 12/24  
Amp: 25/12.5

 Mount. hole size:  
22 mm

 Button colour: Black  
Switch: Off/(On)  
Material: Metal  
No./terminals w/screw: 2  
DIN norm: 72764

**180215** Push Button Switch

 Voltage: 12/24  
Amp: 25/12.5

 Mount. hole size:  
22.5 mm

 Switch: Off/(On)  
No./terminals w/screw: 2  
Moulded: Yes  
Silver contact: Yes

**180400** Push Button Switch

*Depth: 20 mm.*

 Voltage: 12/24  
Amp: 7/3.5

 Mount. hole size:  
15.5 mm

 Type/terminal: Screw  
Button colour: Black  
Switch: Off/(On)  
No./terminals w/screw: 2

**181272** Rubber Boot

Servicing: HC-CARGO 180049, 180040, 180215

*Moulded.*

 OD: 28.3 mm  
Length: 18 mm

 Colour: Black  
Material: Rubber

**TOOLS**

**WORKS AND TEST EQUIPMENT**

**BATTERY CHARGERS**

**211036 Battery Charger**



Voltage: 12-24  
Amp: 4-8

Weight: 4.230 kg

Auto stop: No  
Approvals: CE

**211073 Auto/Manual Charger**

230 V. AC.



Voltage: 12-24  
Amp: 8

Weight: 4.950 kg

Auto stop: Yes  
Approvals: CE

**BATTERY TESTER**

**211040 Battery Tester**



Voltage: 12-24

Weight: 0.124 kg

**211041 Battery Tester**

Easy to read digital display.



Voltage: 12/24

Weight: 0.070 kg

**CIRCUIT TESTER**

**211083 Power Probe II**

w/ this adaptor you can use HC-CARGO 211058 for check of 7 pole and 7/13 multicon sockets. Rocker Switch HC-CARGO 211123.



Voltage/DC: 6-24 V Length/test cable: 6 m Test cable incl.: Yes

**211097 Circuit Tester**

Features: test light. Short circuit indicator. Continuity tester. Indicator for poor ground connection. Short circuit protection. Voltmeter. 6 m cable. Rocker Switch HC-CARGO 211123.



Voltage/DC:  
12-24 V

Colour: Red