



TRUCKS, TRAILERS & BUSES



2016/2017



HC-CARGO Always Online

The products you require are only a few clicks away!

www.hc-cargo.com





TRUCKS, TRAILERS & BUSES

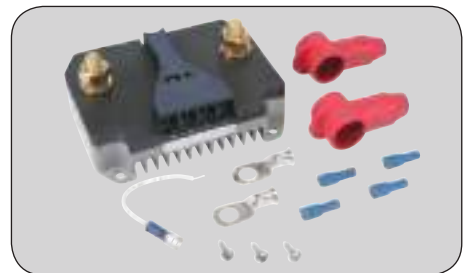

www.hc-cargo.com

Edition 2016/2017







Trucks, Trailers & Buses

All commercial vehicles have one thing in common - they have to stay in operation in order to be profitable; therefore a fast and reliable supply of parts is important, particularly for last-minute repairs.

Engines in trucks, buses, LCV etc. must fulfill many requirements: mainly focused on power, endurance and cleanliness.

HC-CARGO aim for high market coverage and offer solutions for the most common applications based on complete system competence.

In our truck, trailer and buses assortment we offer you a wide selection of starters, alternators, A/C compressors, and accessories for commercial vehicles applications.

A/C

These days air conditioners are a standard feature in most vehicles. The HC-CARGO air conditioning program (compressors, condensers, dryers, universal parts, diagnostic tools) has a special focus on the most common commercial vehicles in Europe, which you will also be able to find in this catalogue.

Accessories - Lighting

Additional lamps provide extra safety when driving in dark, snowy, foggy or rainy conditions. HC-CARGO offers a wide range of innovative lighting products in terms of brightness, lifetime (long lasting) and power consumption (economical).

Products both for interior and exterior vehicle lighting fulfill the strictest legal safety regulations. Regular product testing and supplier audits ensure the quality and durability of HC-CARGO lighting products. The range is continuously extended with the latest state-of-the-art products in the market. For example: Rotating amber LED beacons, rear multi-function lamps, work lamps and LED lamps.

Electrical Components

Products which are required in the electrical workshop or by the specialist who specialises in building complete electrical systems for the automotive customer. CCTV rear observation systems for the professional and personal user, fans and blowers, cabin heaters, electrical power management products and many more.

Workshop Consumables

We offer a comprehensive range of components [etc]. This includes cables, wiring and installation material specifically for fitting electrical components and accessories. In addition to this, there are a wide range of universal relays included together with specific relays for diesel applications. Furthermore, you will also find crimping tools and special tools for the purpose of dismantling and assembling starters and alternators and other [etc] electrical tools such as multi meters.

High quality spare parts for starters and alternators - All you need

In our separate catalogues for components you can see our comprehensive range of spare parts for starters and alternators. We cover virtually all vehicles in the European market. Here you find what you need in bearings, pulleys, rotors, stators, regulators, rectifiers, brush sets, drives clutches, solenoids, armatures etc. Here you can also find a complete cross reference and application list.

Our engineers test the spare parts thoroughly in terms of best interaction, perfect fit and easy installation, before the products are sourced. In this way we continuously ensure high aftermarket quality.

Visit www.hc-cargo.com for a full program view and e-shop

As we are continuously developing and extending our program you get the up-to-date and complete program by using our web-catalogue at www.hc-cargo.com

With the HC-CARGO program you have a one-stop-shop opportunity regarding electrical parts for your truck, trailer and bus customers.



Beside our web-catalogue the HC-CARGO program on starters, alternators, A/C compressors and A/C universal parts, is also available online on TecDoc in which new applications are continually added as well as latests and updated technical information.

PAGE

ALTERNATORS

<u>Bosch</u>	8
<u>Butec</u>	16
<u>CAV</u>	18
<u>Denso</u>	19
<u>Ducellier</u>	20
<u>Femsa</u>	21
<u>Ford</u>	22
<u>Hitachi</u>	23
<u>Iskra</u>	25
<u>Leece-Neville</u>	29
<u>Lucas</u>	30
<u>Magneti Marelli</u>	32
<u>Magneton (pal/skoda)</u>	33
<u>Miscellaneous</u>	52
<u>Mitsubishi</u>	34
<u>Motorola</u>	36
<u>Motorola USA</u>	38
<u>Poong Sung</u>	39
<u>Prestolite</u>	40
<u>Remy (Delco)</u>	42
<u>Sawafuji</u>	46
<u>SEV</u>	47
<u>United Technologies</u>	48
<u>Valeo</u>	49

STARTERS

<u>Bosch</u>	54
<u>Butec</u>	64
<u>CAV</u>	67
<u>Denso</u>	69
<u>Ducellier</u>	70
<u>Elmot</u>	71
<u>Ford</u>	73
<u>Halla</u>	74
<u>Hitachi</u>	75
<u>Iskra</u>	76
<u>Leece-Neville</u>	81
<u>Lucas</u>	82
<u>Magneti Marelli</u>	84

PAGE

STARTERS

<u>Magneton (Pal/Skoda)</u>	85
<u>Miscellaneous</u>	106
<u>Mitsubishi</u>	88
<u>Nikko</u>	92
<u>Panasonic</u>	93
<u>Prestolite</u>	94
<u>Remy (Delco)</u>	95
<u>Romania (e/p)</u>	101
<u>Sawafuji</u>	102
<u>United Technologies</u>	103
<u>Valeo</u>	104

DC MOTORS

.....	107
-------	-----

COMPRESSORS

<u>Denso</u>	112
<u>Ford</u>	113
<u>Miscellaneous</u>	120
<u>Panasonic</u>	114
<u>Sanden</u>	115

A/C EQUIPMENT

<u>Condensers</u>	125
<u>Dryers</u>	121
<u>Universal Parts</u>	129

LIGHTING

<u>Beacon Sockets</u>	227
<u>Bulbs</u>	229
Conventional	233
Electric Vehicles and Forklifts	234
Festoon	231
H1 Halogen	230
H11 American Types	231
H2 Halogen	230
H21W Halogen	231
H3 Halogen	230
H4 Halogen	230

ABBREVIATIONS:

A10=With Immobiliser, A45=With safety switch, A45=5*, AC=Air Condition, ACPS=Air condition and Power Steering, Alu=Aluminium, A=Ampere, AT=Automatic Transmission, BO=Bosch type, BOGR=Bosch Gear reduction, Cat.=Catalyzer, Ch.=Chassis, Cyl.=Cylinder, CW=Clockwise rotation, DR=Delco Remy type, Eur.=European application, FWD.=Front Wheel Drive, H=Hight, HD=Heavy Duty construction, HP=Horse Power, ID=Inner Diameter, kW=Kilowatt, L=Length, LHD=Left Hand Drive, LL.=Lead Length, M=Minimum supply, MI=Mitsubishi type, MT=Manual Transmission, m=Metre, OD=Outer Diameter, O.E.=Original Equipment, PR=Paris Rhone type, PS=Power Steering, RHD=Right Hand Drive, Th.=Thickness, V=Volt, W/=With, W/o=Without, W=Watt, 4WD.=Four Wheel Drive, []=Eng. no., 3(2)=Number of fixing holes-number in bracket represent threaded holes.

	PAGE
<u>Bulbs</u>	229
H7 Halogen	231
Halogen	234
Instrument Panel	234
Parking and Flasher - Position	231
Spare Lamp Kits	235
Stop and Flasher - Position	232
Stop and Tail Lamps	231
Wedge Base	232
Wedge Base - Covers	233
<u>Forward Lighting</u>	144
Driving Lamp Conventional	144
Driving Lamp LED	145
Flasher-Position Lamps Conventional	146
Flasher-Position Lamps LED	147
Fog Lamps	153
Headlight Inserts	148
LED Daytime Running Light Sets	148
Position Lamps Conventional	149
Position Lamps LED	150
Tractor Head Lamps	154
<u>Interior Lamps Fluorescent</u>	138
Resolux 505	138
Resolux 720	138
Slim Styling	138
Spare Parts	139
<u>Interior Lamps LED</u>	134
<u>Reflectors</u>	154
Accessories	158
Rear Marking Trailers	158
Rear Marking Trucks	159
Warning Triangles	161
<u>Side Indicators Conventional</u>	143
Spare Parts	144
<u>Side Indicators LED</u>	144
<u>Side Marker Lamps Conventional</u>	142
Spare Parts	143
<u>Side Marker Lamps LED</u>	139
Accessories	141
<u>Tail Lights</u>	162
Multi Function Lamps	162
Numberplate Lamps Conventional	180

	PAGE
<u>Tail Lights</u>	162
Numberplate Lamps LED	182
Rear Fog Lamps Conventional	184
Rear Fog Lamps LED	185
Reversing Lamps Conventional	183
Reversing Lamps LED	184
Tail Lamps Conventional	186
Tail Lamps LED	187
Tail Position Lamps Conventional	189
Tail Position Lamps LED	191
Tail-Lift Lamps Conventional	186
Tail-Lift Lamps LED	186
<u>Warning Lights</u>	195
Flash Lights LED	195
Light Bars Conventional	201
Light Bars LED	201
Rotating Beacons Conventional	204
Rotating Beacons LED	208
Rotating Beacons Xenon	213
<u>Work Lamps Conventional</u>	214
<u>Work Lamps HID</u>	226
Spare Parts	227
<u>Work Lamps LED</u>	215
Accessories	226
Work Light Bars LED	223
ELECTRICAL COMPONENTS	
<u>Acoustic Warning</u>	238
B buzzers	238
Horns	238
Reversing Alarms	239
<u>Cabin Heaters</u>	240
Heater Motors	240
<u>Camera & Parking Sensors</u>	240
CCTV Rear Observation System	240
<u>Dashboard Gauges</u>	251
Ammeter	251
Fuel Gauges	252
Hour Meter	252
Oil Pressure Gauges	252
Voltmeter	253
Water Temp. Gauges	253

Care is taken to ensure the accuracy of descriptions and applications of each item, but assumes no responsibility for possible errors. O.E.M. names and numbers are used for reference purposes only.
 Printed in Germany. Copyright © 2016 Holger Christiansen A/S, A Bosch Group Company

PAGE

<u>Fans & Blowers</u>	247
Axial Fans	247
Blowers	250
Fan/Heater Motors	251
<u>Power Management Components</u>	253
Battery Isolators	254
Chargers	253
Power Guard	255
Relay Boxes	256
<u>Pumps & Pump Parts</u>	256
Electrical Bilge Pumps	256
Electrical Fluid Pumps	256
Electrical Fuel Pumps	257
Electrical Water Pumps	258
<u>Relay & Switches</u>	308
Relays	308
<u>Solenoid Shutdown</u>	258
Externally Switched	260
Internally Switched	259
Pull Coil Timer Modules	263
<u>Switches & Sensors - Engine Management</u>	263
Sensors	269
Switches	263
<u>Wiper Systems</u>	269
Windscreen Washers	269
Wiper Arms	271
Wiper Blades	271
Wiper Motors	272

WORKSHOP CONSUMABLES

<u>Cable & Wiring</u>	276
Connectors	276
Flexible Convuluted Tubing	281
<u>Indicator Lights</u>	282
LED	283
<u>Industrial Battery Connectors</u>	284
100 Ampere	286
160 Ampere	287
175 Ampere	288
250 Ampere	289
300 Ampere	291
320 Ampere	291
350 Ampere	291
50 Ampere	284
80 Ampere	286

PAGE

<u>Multiple Connectors</u>	292
Power	292
<u>Plugs & Sockets</u>	292
Adapters - 12/24 V	292
Adapters 12 V	293
DIN and Cigarette Lighter	293
NATO Cable Connectors	296
Trailer Coils 24 V	297
Trailer Plugs - 24 V	299
Trailer Plugs - 6/24 V	299
Trailer Sockets - 12 V	302
Trailer Sockets - 24 V	302
Trailer Sockets - 6/24 V	302
<u>Relay & Switches</u>	306
Circuit Breakers	306
Relays	307
Switches	314
<u>Tools</u>	325
Works and Test Equipment	325
<u>Application List - Alternator & Starters</u>	327
<u>Application List - A/C Compressors, Condensers & Dryers</u>	513
<u>Cross Reference List</u>	587
<u>Index</u>	631



Alternators

A: Pulley distance, B: Width of holder arm, C: Mounting bracket distance

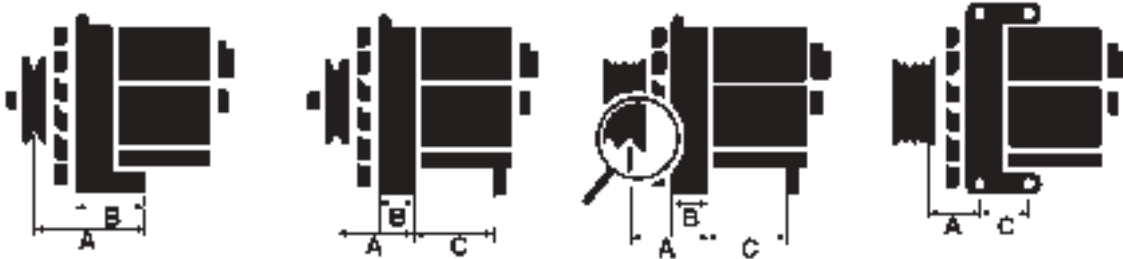

Threaded fixing holes

Remarks: Serpentine pulley

Edition 2016/2017





110112 Alternator 28 V, 40 Amp
 Replacing: 9129080088, 9120080114, 9120080088, 0120489643
 Servicing: Volvo, Volvo Penta
 B+ M6, Terminal W, Pulley w/o, Fan w/o
 B: 51.00 mm



110113 Alternator 28 V, 27 Amp
 Replacing: 0120489728, 0120489727, 0120489284, 0120489231, 0120489225, 0120489221, 0120400774
 Servicing: Mercedes-Benz
 B+ M6, Pulley w/o, Fan EF
 B: 80.00 mm



110116 Alternator 28 V, 35 Amp
 Replacing: 0120489827, 0120489684, 0120489230, 0120489053, 0120488289, 0120488273, 0120488208, 0120400796
 Servicing: DAF, Ford, MAN
 B+ M8, Terminal W, Pulley w/o, Fan w/o
 B: 80.00 mm



110117 Alternator 28 V, 35 Amp
 Manufacturer: Valeo
 Replacing: 0120489731
 Servicing: Iveco, Magirus-Deutz, Steyr, Various Agriculture Vehicles
 B+ M6, Pulley w/o, Fan EF
 B: 56.00 mm

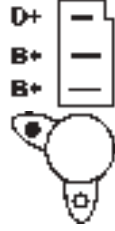

110178 Alternator 14 V, 36 Amp
 Manufacturer: Lucas
 Replacing: 9120331913, 9120331901, 9120331502, 0120389503, 0120389502, 0120339510, 0120339509, 0120339506
 Servicing: Austin, Bedford, Case, Ford, Jensen, Land Rover, Lotus, Massey Ferguson, MG, Morris, New Holland, Plymouth, Talbot
 B+ 9.40, Pulley w/o, Fan EF
 B: 10.00 C: 87.00 mm



110751 Alternator 14 V, 35 Amp
 Replacing: 9120080183, 9120080148, 0120489724, 0120489723
 Servicing: Mercedes-Benz
 B+ M8, Terminal W, Pulley w/o, Fan w/o
 B: 80.00 mm

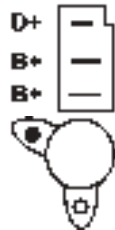

110759 Alternator 14 V, 35 Amp
 Replacing: 0120489940, 0120489894, 0120489804, 0120489803, 0120489616, 0120489562, 0120489561, 0120489536
 Servicing: Austin, Ford, Mercury
 B+ 9.40, Grooves 1, Pulley P, Fan EF
 A: 36.15 B: 10.50 C: 79.00 mm



110761 Alternator 28 V, 35 Amp
 Replacing: 0120489944, 0120488271
 Servicing: Deutz-Fahr, MAN, Mercedes-Benz
 B+ M6, Terminal W, Pulley w/o, Fan w/o
 Fan: HC-CARGO 133875.
 B: 80.00 mm



110766 Alternator 28 V, 27 Amp
 Replacing: 0120489730, 0120489707, 0120489023, 0120488224, 0120400805, 0120400791, 0120400790, 0120400760
 Servicing: Atlas Copco, Case, Deutz-Fahr, Iveco, KHD, Liebherr, Magirus-Deutz, Mercedes-Benz, Steyr
 B+ M6, Terminal W, Pulley w/o, Fan EF
 B: 56.00 mm



110801 Alternator 28 V, 45 Amp
 Replacing: 0122469003, 0122469001
 Servicing: Atlas Copco, Case, Caterpillar, Cummins, Fiat-Allis, International
 B+ 1/4" UNF, Terminal W, Pulley w/o, Fan EF
 B: 14.80 C: 100.00 mm



110895 Alternator 28 V, 55 Amp
 Replacing: 6033GB3055, 6033GB3053, 6033GB3047, 0120469982, 0120469686, 0120469518, 0120469509, 0120469103
 Servicing: DAF, Kässbohrer, MAN, Mercedes-Benz, Ssangyong
 B+ M8, Terminal W, Pulley w/o, Fan EF
 B: 80.00 mm



110906 Alternator 28 V, 30 Amp
 Replacing: 0120489316
 Servicing: Mercedes-Benz
 B+ M8, Terminal W, Pulley w/o, Fan w/o
 B: 80.00 mm

110923 Alternator 14 V, 55 Amp

Replacing: 0120489355, 0120489354, 0120489333, 0120489332, 0120489331, 0120489324, 0120489323, 0120489302

Servicing: Mercedes-Benz

B+ Plug, Grooves 6, Pulley SP, Fan EF

A: 92.00 B: 56.00 mm

111141 Alternator 14 V, 55 Amp

Replacing: 0120489757, 0120489726, 0120489725, 0120489315, 0120489032, 0120488282, 0120400700

Servicing: MAN, Mercedes-Benz

B+ M6, Terminal W, Pulley w/o, Fan w/o

B: 80.00 mm



111146 Alternator 28 V, 55 Amp

Replacing: 0120469983, 0120469891, 0120469761, 0120469692, 0120469592, 0120469562, 0120469527, 0120469038

Servicing: DAF, Ford, MAN

B+ M8, Terminal W, Pulley w/o, Fan w/o

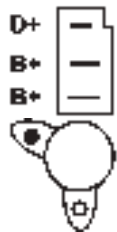
B: 80.00 mm

111289 Alternator 14 V, 70 Amp

Replacing: 9120331872, 9120331864, 9120331854, 0120489957, 0120489896, 0120489895, 0120489889, 0120489844

Servicing: Austin, Case, Dronningborg, Ford, Land Rover, Massey Ferguson, MG, Morris, Rover

B+ 9.40, Terminal W, Grooves 1, Pulley P, Fan EF

A: 35.00 B: 12.50 C: 80.00 mm

111419 Alternator 28 V, 55 Amp

Replacing: 0120469890, 0120469634, 0120469549

Servicing: Allis Chalmers, BENFRA, Fiat-Allis, Iveco, Laverda

B+ M8, Terminal W, Grooves 2, Pulley DP, Fan EF

A: 50.00 B: 17.45 C: 63.00 mm

111528 Alternator 28 V, 55 Amp

Replacing: 0120469523

Servicing: Volvo, Volvo BM, Volvo Penta

B+ M8, Terminal W, Pulley w/o, Fan EF

B: 51.50 mm

111629 Alternator 28 V, 120 Amp

Replacing: 0120689591, 0120689551, 0120689533, 0120689532, 0120689520, 0120689515, 0120689513, 0120689512

Servicing: MAN, Mercedes-Benz, Setra

B+ M8, Terminal W, Pulley w/o, Fan EF

B- M8. Shaft 30 mm. Heavy duty type: HC-CARGO 113589. 180 A.

B: 15.00 C: 180.00 mm

111631 Alternator 28 V, 55 Amp

Replacing: 6033GB3020, 6033G3073B, 6033G3020B, 0120469044, 0120469033, 0120469018

Servicing: Volvo

B+ M8, Terminal W, Pulley w/o, Fan EF

B: 14.10 C: 100.00 mm

111746 Alternator 28 V, 80 Amp

Replacing: 6033GB3021, 0120468144, 0120468135, 0120468093

Servicing: Volvo

B+ M8, Terminal W, Pulley w/o, Fan EF

B: 14.50 C: 112.40 mm

111833 Alternator 28 V, 140 Amp

Replacing: 0120689587, 0120689574, 0120689571, 0120689535, 0120689530

Servicing: Drögmöller, Mercedes-Benz, Setra, Various Agriculture Vehicles

B+ M8, Terminal W, Pulley w/o, Fan EF

B- M8. Shaft 30 mm. Heavy duty type: HC-CARGO 113589. 180 A.

B: 15.70 C: 182.00 mm

111834 Alternator 28 V, 55 Amp

Replacing: 9120145002, 0120469960, 0120469959, 0120469900, 0120469826, 0120469807, 0120469763, 0120469693

Servicing: Scania

B+ M8, Terminal W, Pulley w/o, Fan EF

Heavy duty type: HC-CARGO 112182 (80 A).

B: 80.00 mm

111842 Alternator 28 V, 140 Amp

Replacing: B120600100, 0120689582, 0120689575, 0120689569, 0120689541, 0120689540, 0120689527, 0120689522

Servicing: Ikarus, MAN, Mercedes-Benz, Neoplan

B+ M8, Terminal W, Pulley w/o, Fan EF

B- M8. Shaft 30 mm.

B: 15.00 C: 180.00 mm

111886 Alternator 28 V, 65 Amp

Replacing: 6033GB3034, 6033GB3033, 0120468131

Servicing: Scania

B+ M8, Terminal W, Pulley w/o, Fan w/o

B: 23.25 C: 68.70 mm

111890 Alternator 14 V, 90 Amp

Replacing: 0123340007, 0123320041

Servicing: Mercedes-Benz

B+ M8, Terminal W, Grooves 6, Pulley SP/FW, Fan IF

A: 92.00 B: 56.00 mm

111987 Alternator 28 V, 55 Amp

Replacing: 6333G3013B, 0120469999, 0120469978, 0120469849, 0120469679, 0120469673, 0120469113, 0120469110

Servicing: Iveco

B+ M8, Terminal W, Pulley w/o, Fan EF

B: 17.00 C: 63.80 mm

112046 Alternator 14 V, 95 Amp

Replacing: 0120484001

Servicing: Deutz-Fahr, Iveco

B+ M8, Terminal W, Grooves 8, Pulley SP, Fan EF

A: 84.00 B: 56.00 mm

112076 Alternator 28 V, 80 Amp

Replacing: 0120468999, 0120468139, 0120468130, 0120468129, 0120468124, 0120468116, 0120468094, 0120468065

Servicing: Iveco, Renault V.I., Scania

B+ M8, Terminal W, Pulley w/o, Fan EF

B: 27.00 C: 72.10 mm

112097 Alternator 28 V, 30 Amp

Replacing: 0120489796, 0120489795, 0120489794, 0120489793, 0120489792, 0120489639, 0120489638, 0120489612

Servicing: Allis Chalmers, Astra, Fahr, Iveco, Laverda

B+ M6, Grooves 1, Pulley P, Fan w/o

A: 45.00 B: 17.00 C: 63.00 mm

112098 Alternator 14 V, 65 Amp

Replacing: 0120489711, 0120489710, 0120489294, 0120489022, 0120488233, 0120488138, 0120488134, 0120400845

Servicing: Case, Claas, Eicher, Iveco, Lamborghini, Mercedes-Benz, NSU, Steyr, Zetor

B+ M6, Terminal W, Grooves 1, Pulley P, Fan EF

A: 77.00 B: 56.00 mm

112159 Alternator 28 V, 80 Amp

Replacing: B120500755, 6033GB3054, 6033GB3006, 0120468138, 0120468137, 0120468118, 0120468117, 0120468115

Servicing: DAF, MAN, Mercedes-Benz, Renault V.I.

B+ M8, Terminal W, Pulley w/o, Fan EF

B: 80.40 mm

112182 Alternator 28 V, 80 Amp

Servicing: Scania

B+ M6, Terminal W, Pulley w/o, Fan w/o

As HC-CARGO 111834 (55 A).

B: 80.10 mm

112189 Alternator 28 V, 80 Amp

Replacing: 0120468162, 0120468154, 0120468140

Servicing: Renault V.I.

B+ M8, Terminal W, Pulley w/o, Fan EF, Insulated return

B: 27.00 C: 71.25 mm

112288 Alternator 28 V, 55 Amp

Replacing: B120421892, 0120469753, 0120469752, 0120469580, 0120469579, 0120450015, 0120450010

Servicing: Mercedes-Benz, Steyr

B+ M8, Terminal W, Pulley w/o, Fan w/o

B: 56.00 mm

112302 Alternator 28 V, 120 Amp

Replacing: 0120689550, 0120689539, 0120689538, 0120689524, 0120689516

Servicing: Iveco

B+ M8, Pulley w/o, Fan EF, Not Insulated return

B- M8.

B: 16.00 C: 86.00 mm

112330 Alternator 14 V, 55 Amp

Replacing: 9120334638, 9120334634, 9120334633, 6033GB4021

Servicing: Nissan

B+ M6, Terminal W, Grooves 1, Pulley P, Fan EF

A: 43.00 B: 13.30 C: 80.60 mm

112343 Alternator 28 V, 140 Amp

Replacing: 0120689573, 0120689566, 0120689561, 0120689552, 0120689548, 0120689543, 0120689514, 0120689511

Servicing: Renault V.I., Scania, Volvo

 B+ M8, Terminal W, Pulley w/o, Fan EF
 B- M8. Shaft 30 mm.

B: 15.30 C: 182.00 mm

112345 Alternator 28 V, 55 Amp

Replacing: 0120469798, 0120469014

Servicing: Volvo

B+ M8, Terminal W, Pulley w/o, Fan w/o

B: 51.50 mm

112394 Alternator 14 V, 70 Amp

Replacing: 9120334642, 6033GB4018

Servicing: Nissan

B+ M6, Grooves 1, Pulley P, Fan EF

A: 41.90 B: 13.50 C: 80.00 mm

112424 Alternator 28 V, 140 Amp

Replacing: 0120689562

Servicing: Scania

B+ M8, Pulley w/o, Fan EF

B- M8. Shaft 30 mm.

B: 15.50 C: 182.00 mm

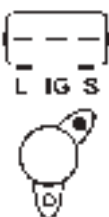
112427 Alternator 28 V, 90 Amp

Replacing: 0123525502

Servicing: Iveco

B+ M8, Grooves 12, Pulley SP, Fan IF

A: 90.00 B: 57.60 mm

112529 Alternator 14 V, 90 Amp

Replacing: 0123335003, 0123320061, 0123320045, 0123320010, 0123315501

Servicing: Daewoo, John Deere, Mercedes-Benz, Ssangyong

B+ M8, Terminal W, Grooves 6, Pulley SP, Fan IF

A: 92.00 B: 56.10 mm

112561 Alternator 28 V, 80 Amp

Replacing: 6033GB3027, 6033GB3022, 6033GB3019, 0120469117, 0120469116, 0120469115

Servicing: Mercedes-Benz

B+ M8, Terminal W, Pulley w/o, Fan EF

B: 80.00 mm

112734 Alternator 14 V, 80 Amp

Replacing: 0120469948, 0120469946, 0120469928, 0120469897, 0120469896, 0120469894, 0120469812, 0120469811

Servicing: Mercedes-Benz

B+ M8, Grooves 6, Pulley SP, Fan EF

A: 91.50 B: 56.00 mm

112736 Alternator 14 V, 65 Amp

Replacing: 0120489756

Servicing: Deutz-Fahr, Fahr, Iveco

B+ M6, Terminal W, Grooves 1, Pulley P, Fan EF

A: 76.50 B: 56.10 mm

112742 Alternator 14 V, 90 Amp

Replacing: 0120469749, 0120469522, 0120469507

Servicing: Valtra, Volvo, Volvo BM

B+ M8, Terminal W, Grooves 2, Pulley DP, Fan w/o

A: 72.50 B: 51.00 mm

112747 Alternator 28 V, 55 Amp

Replacing: 0120469772, 0120469585, 0120469521, 0120469520, 0120469519, 0120469102, 0120469030, 0120469008

Servicing: Deutz-Fahr, Ford, Iveco, KHD

B+ M8, Terminal W, Pulley w/o, Fan EF

B: 56.00 mm



112757 Alternator 28 V, 55 Amp
 Replacing: 0120469963, 0120469920
 Servicing: Scania, Volvo
 B+ M8, Terminal W, Pulley w/o,
 Fan EFBosch 0 120 469 963 = Insulated, HC-CARGO 112757 is not insulated
 B: 27.50 C: 68.00 mm



112784 Alternator 28 V, 45 Amp
 Replacing: 0120489303, 0120489060,
 0120488643
 Servicing: Volvo, Volvo Penta
 B+ M6, Terminal W, Pulley w/o,
 Fan w/o
 B: 50.00 mm



112803 Alternator 28 V, 80 Amp
 Replacing: 0120468114, 0120468037
 Servicing: Volvo
 B+ M8, Terminal W, Pulley w/o, Fan EF
 B: 51.00 mm



113186 Alternator 28 V, 55 Amp
 Replacing: 0120469032
 Servicing: Volvo
 B+ M8, Terminal W, Pulley w/o, Fan EF
 Heavy duty type: HC-CARGO 113650 (80 A)..
 B: 13.80 C: 83.00 mm

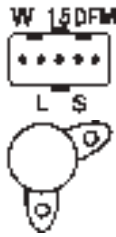

113188 Alternator 28 V, 70 Amp
 Replacing: 0124555005
 Servicing: Iveco
 B+ M8, Terminal W, Pulley w/o, Fan IF
 B: 14.10 C: 80.90 mm

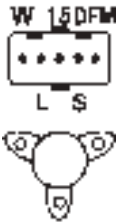

113284 Alternator 28 V, 80 Amp
 Replacing: 0124555041, 0124555040,
 0124555003
 Servicing: DAF, Peugeot
 B+ M8, Terminal W, Pulley w/o, Fan IF
 B: 80.50 mm

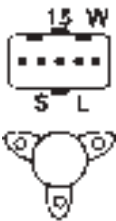

113289 Alternator 28 V, 90 Amp
 Replacing: 0123525501
 Servicing: MAN, Neoplan
 B+ M8, Terminal W, Pulley w/o, Fan IF
 B: 80.20 mm



113291 Alternator 14 V, 55 Amp
 Replacing: 9120334641, 6033GB4009
 Servicing: Nissan
 B+ M6, Terminal W, Grooves 1,
 Pulley P, Fan EF
 A: 39.30 B: 13.40 C: 80.00 mm



113295 Alternator 28 V, 55 Amp
 Replacing: 0123325500
 Servicing: MAN
 B+ M8, Terminal W, Pulley w/o, Fan IF
 B: 80.25 mm



113351 Alternator 28 V, 100 Amp
 Replacing: 0124655097, 0124655023,
 0124655016, 0124655004, 0124655002,
 0124655001, 0124555065, 0124555032
 Servicing: Mercedes-Benz
 B+ M8, Terminal W, Pulley w/o, Fan IF
 B: 80.00 mm



113376 Alternator 14 V, 55 Amp
 Replacing: 0120489769, 0120489768,
 0120489636, 0120489635, 0120489626,
 0120489625, 0120489586, 0120489585
 Servicing: Bedford, Opel, Vauxhall
 B+ M6, Terminal W, Grooves 1,
 Pulley P, Fan EF
 A: 76.60 B: 56.20 mm



113448 Alternator 28 V, 100 Amp
 Replacing: 6033GB3083, 6033GB3023,
 6033GB3010, 0120501151, 0120469119,
 0120468145, 0120468143
 Servicing: Mercedes-Benz
 B+ M8, Terminal W, Pulley w/o, Fan EF
 B: 80.00 mm

113470 Alternator 28 V, 35 Amp

Replacing: 0120488283, 0120488234, 0120488153

 Servicing: Iveco, KHD, Liebherr
 B+ M6, Terminal W, Grooves 1, Pulley P, Fan w/o

A: 77.00 B: 55.80 mm

113611 Alternator 14 V, 90 Amp

Replacing: 0120469895, 0120469687, 0120469540, 0120469526, 0120469506, 0120469013

 Servicing: Claas, Mercedes-Benz
 B+ M8, Terminal W, Pulley w/o, Fan EF
 B: 81.30 mm

113895 Alternator 28 V, 80 Amp

Manufacturer: Bosch

Replacing: 6033GB3045

 Servicing: Various Industrial applications
 B+ M8, Terminal W, Pulley w/o, Fan EF
 B: 56.00 mm

113920 Alternator 28 V, 35 Amp

Replacing: 0120488291, 0120488278, 0120488277, 0120488256, 0120400728

 Servicing: MAN, Mercedes-Benz, Padane
 B+ M8, Terminal W, Pulley w/o, Fan w/o

B: 80.40 mm

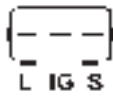
113923 Alternator 28 V, 90 Amp

Replacing: 0123525503, 0123525500

 Servicing: Iveco
 B+ M8, Grooves 10, Pulley SP, Fan IF, Not Insulated return

A: 90.00 B: 58.10 mm

113998 Alternator 28 V, 110 Amp

Replacing: 0124655011, 0124655009

 Servicing: MAN
 B+ M8, Terminal W, Pulley w/o, Fan IF
 B: 79.50 mm

114008 Alternator 28 V, 80 Amp

Replacing: 0124555014

 Servicing: MAN
 B+ M8, Pulley w/o, Fan IF, Not Insulated return

B: 80.00 mm

114028 Alternator 28 V, 80 Amp

Replacing: 0124555008

 Servicing: Scania
 B+ M8, Terminal W, Grooves 8, Pulley SP, Fan IF, Not Insulated return

A: 18.50 B: 85.00 C: 35.50 mm

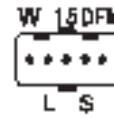
114036 Alternator 28 V, 100 Amp

Replacing: 0124655006, 0124555006

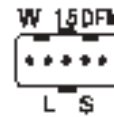
 Servicing: DAF
 B+ M8, Grooves 8, Pulley SP, Fan IF
 A: 37.00 B: 14.00 C: 80.00 mm

114089 Alternator 28 V, 80 Amp

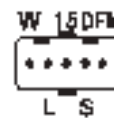
Replacing: 0124555018

 Servicing: Bova, DAF, Solaris
 Terminal W, Fan IF
 B: 97.00 C: 41.50 mm

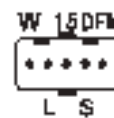
114212 Alternator 28 V, 110 Amp

Replacing: 0124655019, 0124655012, 0124655008, 0124555058, 0124555028, 0124555027, 0124555020, 0124555017

 Servicing: Renault V.I., Volvo
 B+ M8, Pulley w/o, Fan IF
 B: 13.50 C: 106.00 mm

114296 Alternator 28 V, 90 Amp

Replacing: 0124655005

 Servicing: Ginaf, Iveco
 B+ M8, Pulley w/o, Fan IF, Not Insulated return

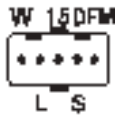
B: 14.00 C: 81.00 mm



114314 Alternator 28 V, 110 Amp
 Replacing: 0124655014
 Servicing: Bova, DAF, Solaris
 B+ M8, Pulley w/o, Fan IF,
 Not Insulated return
 B: 97.00 C: 40.00 mm



114355 Alternator 28 V, 55 Amp
 Replacing: 9120060033
 Servicing: Various
 B+ M8, Terminal W, Grooves 2,
 Pulley DP, Fan EF
 A: 50.00 B: 20.00 mm



114365 Alternator 28 V, 140 Amp
 Replacing: 0120689553
 Servicing: Deutz-Fahr, KHD, MAN
 B+ M8, Terminal W, Pulley w/o, Fan EF
 B: 15.00 C: 180.00 mm

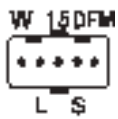

NEW PRODUCT
www.hc-cargo.com

114528* Alternator 28 V, 120 Amp
 Replacing: 0124655025
 Servicing: MAN, Neoplan, Temsa
 B+ M8, Pulley w/o, Fan IF
 B: 80.00 mm

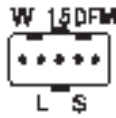

NEW PRODUCT
www.hc-cargo.com

114753* Alternator 28 V, 100 Amp
 Replacing: 0124655026, 0124655007
 Servicing: Scania
 Terminal W, Grooves 8, Pulley SP,
 Fan IF



115481 5★ Alternator 28 V, 110 Amp
 Manufacturer: Bosch
 Replacing: 0124655065
 B+ M8, Terminal W, Grooves 8,
 Pulley SP, Fan IF, Not Insulated return
 A: 37.50 B: 14.00 C: 81.50 mm

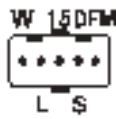

115484 5★ Alternator 28 V, 70 Amp
 Manufacturer: Bosch
 Replacing: 0124555005
 Servicing: Ginaf, Iveco
 B+ M8, Grooves 8, Fan IF
 A: 37.00 B: 14.10 C: 80.60 mm

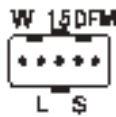

115486 5★ Alternator 28 V, 80 Amp
 Manufacturer: Bosch
 Replacing: 0124555013
 Servicing: MAN

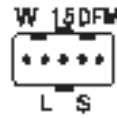

115488 5★ Alternator 28 V, 110 Amp
 Manufacturer: Bosch
 Replacing: 0124655012
 Servicing: Renault V.I., Volvo
 B+ M8, Fan IF
 B: 17.50 C: 106.00 mm

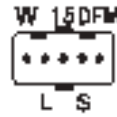

115489 5★ Alternator 28 V, 90 Amp
 Manufacturer: Bosch
 Replacing: 0124655005
 Servicing: Ginaf, Iveco
 B+ M8, Terminal W, Grooves 8, Fan IF
 A: 37.00 B: 14.00 C: 82.00 mm

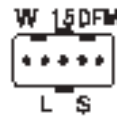

115491 5★ Alternator 28 V, 80 Amp
 Manufacturer: Bosch
 Replacing: 0124555041, 0124555040,
 0124555003
 Servicing: Bova, DAF, Solaris
 B+ M8, Terminal W, Fan IF
 B: 80.00 mm

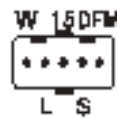

115492 5★ Alternator 28 V, 110 Amp
 Manufacturer: Bosch
 Replacing: 0124655011
 Servicing: MAN
 B+ M8, Terminal W, Pulley w/o, Fan IF
 B: 80.00 mm

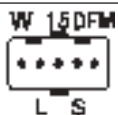

115493 5★ Alternator 28 V, 80 Amp
 Manufacturer: Bosch
 Replacing: 0124555008
 Servicing: Scania
 B+ M8, Terminal W, Grooves 8
 A: 21.00 B: 85.00 C: 35.50 mm

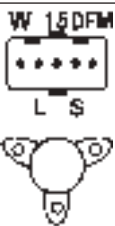

115497 5★ Alternator 28 V, 80 Amp
 Manufacturer: Bosch
 Replacing: 0124555065
 Servicing: Mercedes-Benz
 B+ M8, Terminal W, Fan IF
 B: 80.00 mm

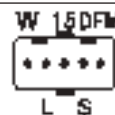

NEW PRODUCT
www.hc-cargo.com

115618* Alternator 28 V, 110 Amp
 Manufacturer: Bosch
 Replacing: 0124655039, 0124655037,
 0124655036, 0124655003
 Servicing: Bova, DAF, Solaris
 Fan IF



115494 5★ Alternator 28 V, 120 Amp
 Manufacturer: Bosch
 Replacing: 0124655331, 0124655021
 Servicing: Volvo
 B+ M8, Terminal W, Grooves 8,
 Pulley SP, Fan IF, Not Insulated return
 A: 45.00 B: 13.60 C: 107.00 mm



115498 5★ Alternator 28 V, 100 Amp
 Manufacturer: Bosch
 Replacing: 0124655007
 Servicing: Scania
 B+ M8, Terminal W, Grooves 8,
 Pulley SP, Fan IF
 A: 20.00 B: 85.00 C: 35.50 mm

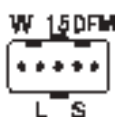

115495 5★ Alternator 28 V, 80 Amp
 Manufacturer: Bosch
 Replacing: 0124555018
 Servicing: Bova, DAF, Solaris
 B+ M8, Grooves 7, Pulley SP, Fan IF
 A: 56.00 B: 97.00 C: 40.50 mm

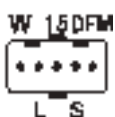

NEW PRODUCT
www.hc-cargo.com

115557 5★ Alternator 28 V, 100 Amp
 Manufacturer: Bosch
 Replacing: 0124655023
 Servicing: Mercedes-Benz
 B+ M8, Terminal W, Pulley w/o, Fan IF
 B: 80.00 mm

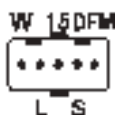

115496 5★ Alternator 28 V, 120 Amp
 Manufacturer: Bosch
 Replacing: 0124655025
 Servicing: MAN, Neoplan, Temsa

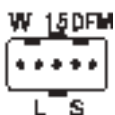

115617 5★ Alternator 28 V, 110 Amp
 Manufacturer: Bosch
 Replacing: 0124655039, 0124655037,
 0124655036, 0124655003
 Servicing: Bova, DAF, Solaris
 B+ M8, Fan IF
 B: 80.00 mm



110113 Alternator 28 V, 27 Amp
 Replacing: 857479, 857475
 Servicing: Mercedes-Benz
 B+ M6, Pulley w/o, Fan EF
 B: 80.00 mm



110116 Alternator 28 V, 35 Amp
 Replacing: 860155, 859020, 858773
 Servicing: DAF, Ford, MAN
 B+ M8, Terminal W, Pulley w/o, Fan w/o
 B: 80.00 mm

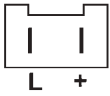

110889 Alternator 14 V, 75 Amp
 Replacing: 860140
 Servicing: Renault, Renault V.I.
 B+ M6, Terminal W, Grooves 1, Pulley P, Fan EF
 A: 57.90 B: 26.90 C: 69.00 mm



110895 Alternator 28 V, 55 Amp
 Replacing: 859820
 Servicing: DAF, Kässbohrer, MAN, Mercedes-Benz, Ssangyong
 B+ M8, Terminal W, Pulley w/o, Fan EF
 B: 80.00 mm



111296 Alternator 28 V, 55 Amp
 Replacing: A5524/49, A5524/39, 858619, 857645, 857623, 857601
 Servicing: Various Agriculture Vehicles, Various Industrial applications
 B+ M6, Terminal W, Pulley w/o, Fan w/o, Insulated return
 B: 76.00 mm



111629 Alternator 28 V, 120 Amp
 Replacing: 860170, 860166
 Servicing: MAN, Mercedes-Benz, Setra
 B+ M8, Terminal W, Pulley w/o, Fan EF
 B- M8. Shaft 30 mm. Heavy duty type: HC-CARGO 113589. 180 A.
 B: 15.00 C: 180.00 mm



111746 Alternator 28 V, 80 Amp
 Replacing: 860551
 Servicing: Volvo
 B+ M8, Terminal W, Pulley w/o, Fan EF
 B: 14.50 C: 112.40 mm



111808[#] Alternator 28 V, 120 Amp
 Replacing: 880638Z
 Servicing: Volvo
 B+ M10, Terminal W, Pulley w/o, Fan EF



111834 Alternator 28 V, 55 Amp
 Replacing: 858882
 Servicing: Scania
 B+ M8, Terminal W, Pulley w/o, Fan EF
 Heavy duty type: HC-CARGO 112182 (80 A).
 B: 80.00 mm

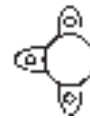

111886 Alternator 28 V, 65 Amp
 Replacing: 860306
 Servicing: Scania
 B+ M8, Terminal W, Pulley w/o, Fan w/o
 B: 23.25 C: 68.70 mm



112076 Alternator 28 V, 80 Amp
 Replacing: 860560, 860134
 Servicing: Iveco, Renault V.I., Scania
 B+ M8, Terminal W, Pulley w/o, Fan EF
 B: 27.00 C: 72.10 mm



112159 Alternator 28 V, 80 Amp
 Replacing: 860558, 860151
 Servicing: DAF, MAN, Mercedes-Benz, Renault V.I.
 B+ M8, Terminal W, Pulley w/o, Fan EF
 B: 80.40 mm



112343 Alternator 28 V, 140 Amp
 Replacing: 860138
 Servicing: Renault V.I., Scania, Volvo
 B+ M8, Terminal W, Pulley w/o, Fan EF
 B- M8. Shaft 30 mm.
 B: 15.30 C: 182.00 mm



112345 Alternator 28 V, 55 Amp
 Replacing: 860135, 858880
 Servicing: Volvo
 B+ M8, Terminal W, Pulley w/o,
 Fan w/o
 B: 51.50 mm



112561 Alternator 28 V, 80 Amp
 Replacing: 860559
 Servicing: Mercedes-Benz
 B+ M8, Terminal W, Pulley w/o, Fan EF
 B: 80.00 mm



112757 Alternator 28 V, 55 Amp
 Replacing: 860157
 Servicing: Scania, Volvo
 B+ M8, Terminal W, Pulley w/o,
 Fan EF Bosch 0 120 469 963 = Insulated, HC-
 CARGO 112757 is not insulated
 B: 27.50 C: 68.00 mm



112803 Alternator 28 V, 80 Amp
 Replacing: 860562, 859983
 Servicing: Volvo
 B+ M8, Terminal W, Pulley w/o, Fan EF
 B: 51.00 mm

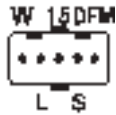

114296 Alternator 28 V, 90 Amp
 Replacing: 860810
 Servicing: Ginaf, Iveco
 B+ M8, Pulley w/o, Fan IF, Not Insulated
 return
 B: 14.00 C: 81.00 mm

110112 Alternator 28 V, 40 Amp

Replacing: 2998054

Servicing: Volvo, Volvo Penta

B+ M6, Terminal W, Pulley w/o, Fan w/o

B: 51.00 mm

110116 Alternator 28 V, 35 Amp

Replacing: 2998055

Servicing: DAF, Ford, MAN

B+ M8, Terminal W, Pulley w/o, Fan w/o

B: 80.00 mm

111629 Alternator 28 V, 120 Amp

Replacing: 1277640

Servicing: MAN, Mercedes-Benz, Setra

 B+ M8, Terminal W, Pulley w/o, Fan EF
 B- M8. Shaft 30 mm. Heavy duty type: HC-CARGO 113589. 180 A.

B: 15.00 C: 180.00 mm

111808# Alternator 28 V, 120 Amp

Replacing: AC203R11524-12, 1285505

Servicing: Volvo

B+ M10, Terminal W, Pulley w/o, Fan EF

111833 Alternator 28 V, 140 Amp

Replacing: 1277670

Servicing: Drögmöller, Mercedes-Benz, Setra, Various Agriculture Vehicles

B+ M8, Terminal W, Pulley w/o, Fan EF

B- M8. Shaft 30 mm. Heavy duty type: HC-CARGO 113589. 180 A.

B: 15.70 C: 182.00 mm

111842 Alternator 28 V, 140 Amp

Replacing: 1277720, 1277690

Servicing: Ikarus, MAN, Mercedes-Benz, Neoplan

 B+ M8, Terminal W, Pulley w/o, Fan EF
 B- M8. Shaft 30 mm.

B: 15.00 C: 180.00 mm

112097 Alternator 28 V, 30 Amp

Replacing: 2998230

Servicing: Allis Chalmers, Astra, Fahr, Iveco, Laverda

B+ M6, Grooves 1, Pulley P, Fan w/o

A: 45.00 B: 17.00 C: 63.00 mm

112343 Alternator 28 V, 140 Amp

Replacing: 1277680

Servicing: Renault V.I., Scania, Volvo

 B+ M8, Terminal W, Pulley w/o, Fan EF
 B- M8. Shaft 30 mm.

B: 15.30 C: 182.00 mm



110117 Alternator 28 V, 35 Amp
 Manufacturer: Valeo
 Replacing: 100211-4201, 100211-4200
 Servicing: Iveco, Magirus-Deutz, Steyr,
 Various Agriculture Vehicles
 B+ M6, Pulley w/o, Fan EF
 B: 56.00 mm

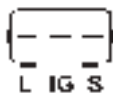

114363 Alternator 28 V, 60 Amp
 Replacing: 101211-7910
 Servicing: Toyota
 B+ M6, Grooves 2, Pulley DP
 A: 92.00 B: 58.40 mm



110679 Alternator 14 V, 60 Amp
 Replacing: 100211-2360, 100211-2290,
 100211-2231, 100211-2230, 100211-2221,
 100211-1331, 100211-1330
 Servicing: Isuzu, Opel
 B+ M6, Grooves 4, Pulley SP, Fan IF
 A: 92.25 B: 58.00 mm



114813 Alternator 28 V, 65 Amp
 Replacing: 101211-8140
 Servicing: Various Agriculture Vehicles,
 Various Industrial applications
 B+ 5/16" UNC, Pulley w/o, Fan EF
 B: 13.00 C: 102.00 mm



110801 Alternator 28 V, 45 Amp
 Replacing: 100211-0860
 Servicing: Atlas Copco, Case, Caterpillar,
 Cummins, Fiat-Allis, International
 B+ 1/4" UNF, Terminal W, Pulley w/o,
 Fan EF
 B: 14.80 C: 100.00 mm



111609 Alternator 14 V, 70 Amp
 Replacing: 101211-0033, 101211-0030,
 100211-9980, 100211-7811, 100211-7810,
 100211-7770, 100211-3311
 Servicing: Honda
 B+ M6, Grooves 5, Pulley SP, Fan IF
 A: 90.00 B: 56.50 mm

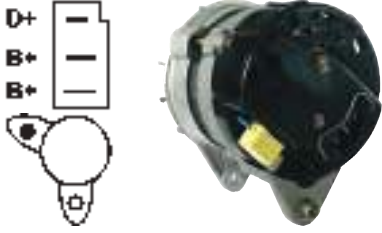

110178 Alternator 14 V, 36 Amp
 Manufacturer: Lucas
 Replacing: 516011
 Servicing: Austin, Bedford, Case, Ford,
 Jensen, Land Rover, Lotus, Massey Ferguson,
 MG, Morris, New Holland, Plymouth, Talbot
 B+ 9.40, Pulley w/o, Fan EF
 B: 10.00 C: 87.00 mm



110178 Alternator 14 V, 36 Amp

Manufacturer: Lucas

Replacing: ALT12N-39, ALT12N-14, ALT12N-11, ALP12N-2

Servicing: Austin, Bedford, Case, Ford, Jensen, Land Rover, Lotus, Massey Ferguson, MG, Morris, New Holland, Plymouth, Talbot

B+ 9.40, Pulley w/o, Fan EF

B: 10.00 C: 87.00 mm

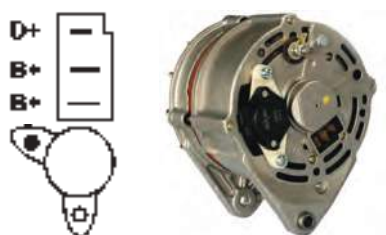

110759 Alternator 14 V, 35 Amp

Replacing: ALP12N-12

Servicing: Austin, Ford, Mercury

B+ 9.40, Grooves 1, Pulley P, Fan EF

A: 36.15 B: 10.50 C: 79.00 mm



111289 Alternator 14 V, 70 Amp

Replacing: ALS12N-75, ALS12N-72, ALS12N-51

Servicing: Austin, Case, Dronningborg, Ford, Land Rover, Massey Ferguson, MG, Morris, Rover

B+ 9.40, Terminal W, Grooves 1, Pulley P, Fan EF

A: 35.00 B: 12.50 C: 80.00 mm

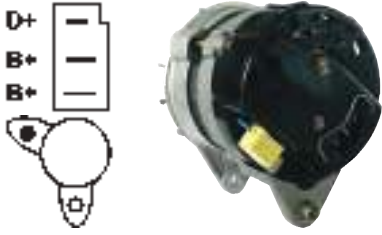

110178 Alternator 14 V, 36 Amp
 Manufacturer: Lucas
 Replacing: 77FB10300FB, 77FB10300FA, 76BB10300ED, 76BB10300EA, 74DB10436A, 69EB10346AD, 5003897, 1537179
 Servicing: Austin, Bedford, Case, Ford, Jensen, Land Rover, Lotus, Massey Ferguson, MG, Morris, New Holland, Plymouth, Talbot
 B+ 9.40, Pulley w/o, Fan EF
 B: 10.00 C: 87.00 mm



110179 Alternator 14 V, 36 Amp
 Manufacturer: Lucas
 Replacing: 86BB10300DB, 86AB10300DA
 Servicing: Bedford, Case, Ford, Jaguar, Land Rover, LDV International, Lotus, Mercury, Triumph, Vauxhall
 B+ 9.40, Pulley w/o, Fan EF
 For pulley w/ 17.00 mm bore use bushing: HC-CARGO 134894.
 B: 9.75 C: 88.00 mm

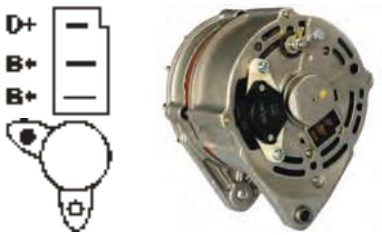

110759 Alternator 14 V, 35 Amp
 Replacing: 80BB10300DB, 80BB10300DA, 72GB10300LB, 72GB10300LA, 71BB10300FB, 71BB10300FA, 6021771, 1553627
 Servicing: Austin, Ford, Mercury
 B+ 9.40, Grooves 1, Pulley P, Fan EF
 A: 36.15 B: 10.50 C: 79.00 mm

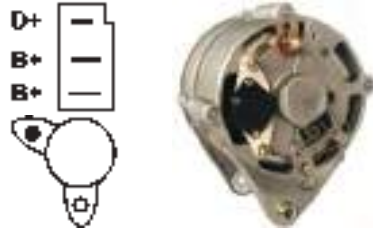

111289 Alternator 14 V, 70 Amp
 Replacing: R72GB10346NA, 89AX10300HA, 89AX10300EA, 89AB10300HA, 89AB10300GB, 89AB10300GA, 89AB10300EB
 Servicing: Austin, Case, Dronningborg, Ford, Land Rover, Massey Ferguson, MG, Morris, Rover
 B+ 9.40, Terminal W, Grooves 1, Pulley P, Fan EF
 A: 35.00 B: 12.50 C: 80.00 mm



112747 Alternator 28 V, 55 Amp
 Replacing: 83DB10346AA, 1620918
 Servicing: Deutz-Fahr, Ford, Iveco, KHD
 B+ M8, Terminal W, Pulley w/o, Fan EF
 B: 56.00 mm



112993 Alternator 14 V, 130 Amp
 Replacing: GL358, GL332, GL-358, GL-332, F8ZU10300AA, F5HZ10346A, F4PU10346BA, F4HT10300KA, F4HT10300FA
 Servicing: Cummins, Ford, International, Volvo
 B+ 1/4" UNF, Terminal W, Pulley w/o, Fan EF
 Replacing: 21SI. Negative grounding. One wire system. B+ 1/4". Shaft is 7/8 In = 22.255 mm
 B: 14.20 C: 101.50 mm



113765 Alternator 14 V, 90 Amp
 Replacing: FOHU10346FA, FOHU10346CA, EZHT10346EB, E4HT10300AA, E2HT10300GA, E2HT10300FA, E2HT10300EB
 Servicing: Various Industrial applications
 B+ 1/4" UNC, Terminal W, Pulley w/o, Not Insulated return
 B: 76.05 mm

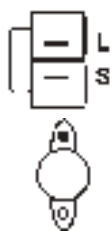

113920 Alternator 28 V, 35 Amp
 Replacing: 1021198
 Servicing: MAN, Mercedes-Benz, Padane
 B+ M8, Terminal W, Pulley w/o, Fan w/o
 B: 80.40 mm

110701 Alternator 14 V, 50 Amp

Replacing: LR150-435T, LR150-435S, LR150-435, LR150-430T, LR150-430S, LR150-430C, LR150-430

Servicing: Nissan

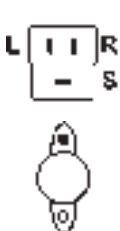
 B+ M6, Grooves 2, Pulley DP, Fan EF
 A: 41.80 B: 13.30 C: 80.50 mm

110702# Alternator 14 V, 70 Amp

Replacing: LR160-164, LR155-408, LR155-16P, LR155-16B, LR150-79S, LR150-79H, LR150-79F, LR150-79E, LR150-79C

Servicing: Nissan

 B+ M6, Grooves 1, Pulley P, Fan EF
 A: 42.25 B: 13.30 C: 80.45 mm

111291# Alternator 14 V, 55 Amp

Replacing: LR155-419B, LR155-419, LR155-418B, LR155-418, LR150-439B, LR150-439, LR150-438B, LR150-438

Servicing: Bedford, Isuzu, Vauxhall

 B+ Plug, Grooves 1, Pulley P, Fan EF
 A: 42.30 B: 13.10 C: 80.45 mm

111316 Alternator 14 V, 60 Amp

Replacing: LR160-437T, LR160-437S, LR160-437, LR160-436T, LR160-436S, LR160-436, LR160-427T, LR160-427S

Servicing: Nissan

 B+ M6, Grooves 2, Pulley DP, Fan EF
 A: 42.00 B: 14.00 C: 81.15 mm

111493 Alternator 28 V, 35 Amp

Replacing: LR225-409E, LR225-409B, LR225-409, LR225-408E, LR225-408C, LR225-408B, LR225-408

Servicing: Isuzu

 B+ 9.40, Grooves 1, Pulley P, Fan EF
 A: 45.50 B: 13.50 C: 80.70 mm

113412 Alternator 14 V, 70 Amp

Replacing: LR170-410, LR170-401

Servicing: Isuzu

 B+ M5, Grooves 2, Pulley DP, Fan EF
 A: 44.75 B: 13.45 C: 81.80 mm

113413 Alternator 14 V, 70 Amp

Replacing: LR170-418C, LR170-418B, LR170-418

Servicing: Chevrolet, Isuzu

 B+ M5, Grooves 2, Pulley DP, Fan EF
 A: 47.30 B: 13.75 C: 81.75 mm

114014 Alternator 28 V, 60 Amp

Replacing: LR260-504B, LR250-508C, LR250-508B, LR250-508

Servicing: Isuzu

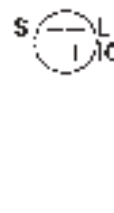
 B+ M6, Grooves 3, Pulley Triple Pulley, Fan EF
 A: 43.00 B: 17.00 C: 78.00 mm

114366 Alternator 28 V, 40 Amp

Replacing: LR240-405

Servicing: Isuzu

 B+ M8, Grooves 1, Pulley P
 A: 44.00 B: 13.00 C: 79.00 mm

114368 Alternator 28 V, 25 Amp

Replacing: LR225-415B

Servicing: Isuzu

 B+ M5, Grooves 1, Pulley P, Not Insulated return
 A: 33.60 B: 13.14 C: 79.90 mm

114373 Alternator 14 V, 80 Amp

Replacing: LR180-511B

Servicing: Isuzu

 B+ M5, Grooves 1, Pulley P, Not Insulated return
 A: 49.00 B: 13.00 C: 84.50 mm

114426 Alternator 28 V, 40 Amp

Replacing: LR240-401

Servicing: Isuzu

 B+ M5, Grooves 2, Pulley DP, Fan EF
 A: 29.50 B: 13.00 C: 78.00 mm



114427 Alternator 14 V, 100 Amp

Replacing: LR180-508B, LR180-508

Servicing: Isuzu

B+ M6, Grooves 1, Pulley P, Fan EF

A: 48.50 B: 13.15 C: 84.80 mm



114428 Alternator 14 V, 100 Amp

Replacing: LR180-512T

Servicing: Isuzu

B+ M6, Grooves 1, Pulley P, Fan EF

A: 47.00 B: 13.10 C: 84.65 mm



114782 Alternator 28 V, 50 Amp

Replacing: LR250-517

Servicing: Isuzu

B+ M6, Grooves 3, Pulley SP

A: 42.00 B: 17.00 C: 78.00 mm

110113 Alternator 28 V, 27 Amp

Replacing: aak4179, AAK1309, AAK1229, aak1213, aak1205, aak1153, aak1125, 11.201.525, 11.201.360, 11.201.201

Servicing: Mercedes-Benz

B+ M6, Pulley w/o, Fan EF

B: 80.00 mm

110117 Alternator 28 V, 35 Amp

Manufacturer: Valeo

Replacing: aak1854, 11.209.447

Servicing: Iveco, Magirus-Deutz, Steyr, Various Agriculture Vehicles

B+ M6, Pulley w/o, Fan EF

B: 56.00 mm



110163 Alternator 28 V, 45 Amp

Replacing: AAK4591, 11.201.789

Servicing: Renault V.I.

B+ M6, Terminal W, Grooves 2, Pulley DP, Fan EF

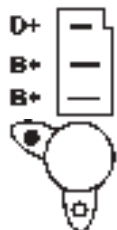
A: 48.75 B: 27.25 C: 67.50 mm

110178 Alternator 14 V, 36 Amp

Manufacturer: Lucas

Replacing: AAK4116, AAG1111, 11.201.272, 11.201.067

Servicing: Austin, Bedford, Case, Ford, Jensen, Land Rover, Lotus, Massey Ferguson, MG, Morris, New Holland, Plymouth, Talbot

B+ 9.40, Pulley w/o, Fan EF

B: 10.00 C: 87.00 mm

110761 Alternator 28 V, 35 Amp

Replacing: AAK3557, AAK1134, 11.201.635

Servicing: Deutz-Fahr, MAN, Mercedes-Benz

B+ M6, Terminal W, Pulley w/o, Fan w/o

Fan: HC-CARGO 133875.

B: 80.00 mm

110766 Alternator 28 V, 27 Amp

Replacing: AAK4509, AAK1352, AAK1204, AAK1167, AAK1115, AAK1113, AAK1109, 11.201.574, 11.201.557, 11.201.186

Servicing: Atlas Copco, Case, Deutz-Fahr, Iveco, KHD, Liebherr, Magirus-Deutz, Mercedes-Benz, Steyr

B+ M6, Terminal W, Pulley w/o, Fan EF

B: 56.00 mm

110895 Alternator 28 V, 55 Amp

Replacing: AAK1367, AAK1347, 11.201.705, 11.201.522

Servicing: DAF, Kässbohrer, MAN, Mercedes-Benz, Ssangyong

B+ M8, Terminal W, Pulley w/o, Fan EF

B: 80.00 mm

110906 Alternator 28 V, 30 Amp

Replacing: AAK1107, 11.201.050

Servicing: Mercedes-Benz

B+ M8, Terminal W, Pulley w/o, Fan w/o

B: 80.00 mm



111141 Alternator 14 V, 55 Amp

Replacing: AAK4549, AAK1301, AAK1130, 11.201.685, 11.201.102, 11.201.097

Servicing: MAN, Mercedes-Benz

B+ M6, Terminal W, Pulley w/o, Fan w/o

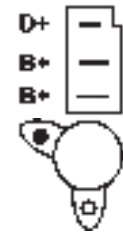
B: 80.00 mm

111289 Alternator 14 V, 70 Amp

Replacing: AAK4524, AAK4520, AAK4519, AAK4513, AAK4135, AAK3590, AAK1358, AAK1114, 11.201.676, 11.201.579

Servicing: Austin, Case, Dronningborg, Ford, Land Rover, Massey Ferguson, MG, Morris, Rover

B+ 9.40, Terminal W, Grooves 1, Pulley P, Fan EF

A: 35.00 B: 12.50 C: 80.00 mm

111419 Alternator 28 V, 55 Amp

Replacing: AAK4507, 11.201.555

Servicing: Allis Chalmers, BENFRA, Fiat-Allis, Iveco, Laverda

B+ M8, Terminal W, Grooves 2, Pulley DP, Fan EF

A: 50.00 B: 17.45 C: 63.00 mm

111528 Alternator 28 V, 55 Amp

Replacing: AAK3332, AAK1369, 11.201.937, 11.201.710

Servicing: Volvo, Volvo BM, Volvo Penta

B+ M8, Terminal W, Pulley w/o, Fan EF

B: 51.50 mm



111629 Alternator 28 V, 120 Amp
 Replacing: AAT1303, 11.201.868
 Servicing: MAN, Mercedes-Benz, Setra
 B+ M8, Terminal W, Pulley w/o, Fan EF
 B- M8. Shaft 30 mm. Heavy duty type: HC-CARGO 113589. 180 A.
 B: 15.00 C: 180.00 mm



111631 Alternator 28 V, 55 Amp
 Replacing: AAK5717, AAK5517, 11.203.573, 11.203.215
 Servicing: Volvo
 B+ M8, Terminal W, Pulley w/o, Fan EF
 B: 14.10 C: 100.00 mm



111746 Alternator 28 V, 80 Amp
 Replacing: AAN5171, 11.203.275
 Servicing: Volvo
 B+ M8, Terminal W, Pulley w/o, Fan EF
 B: 14.50 C: 112.40 mm



111833 Alternator 28 V, 140 Amp
 Replacing: AAT1339, AAT1338, AAT1321, AAT1308, AAT1306, AAT1302, 11.203.241, 11.203.240, 11.203.139
 Servicing: Drögmöller, Mercedes-Benz, Setra, Various Agriculture Vehicles
 B+ M8, Terminal W, Pulley w/o, Fan EF
 B- M8. Shaft 30 mm. Heavy duty type: HC-CARGO 113589. 180 A.
 B: 15.70 C: 182.00 mm



111834 Alternator 28 V, 55 Amp
 Replacing: AAN3114, AAK1398, 11.209.434, 11.201.801
 Servicing: Scania
 B+ M8, Terminal W, Pulley w/o, Fan EF
 Heavy duty type: HC-CARGO 112182 (80 A).
 B: 80.00 mm



111842 Alternator 28 V, 140 Amp
 Replacing: AAT1340, AAT1337, AAT1318, AAT1313, 11.203.242, 11.203.239, 11.203.085, 11.203.001
 Servicing: Ikarus, MAN, Mercedes-Benz, Neoplan
 B+ M8, Terminal W, Pulley w/o, Fan EF
 B- M8. Shaft 30 mm.
 B: 15.00 C: 180.00 mm



111886 Alternator 28 V, 65 Amp
 Replacing: AAN3110, 11.209.420
 Servicing: Scania
 B+ M8, Terminal W, Pulley w/o, Fan w/o
 B: 23.25 C: 68.70 mm



111890 Alternator 14 V, 90 Amp
 Replacing: AAK5322, 11.203.030
 Servicing: Mercedes-Benz
 B+ M8, Terminal W, Grooves 6, Pulley SP/FW, Fan IF
 A: 92.00 B: 56.00 mm



111987 Alternator 28 V, 55 Amp
 Replacing: AAN3118, 11.209.438
 Servicing: Iveco
 B+ M8, Terminal W, Pulley w/o, Fan EF
 B: 17.00 C: 63.80 mm



112046 Alternator 14 V, 95 Amp
 Replacing: AAK4320, AAK3822, AAK1811, AAK1312, 11.204.054, 11.203.656, 11.203.331, 11.201.991
 Servicing: Deutz-Fahr, Iveco
 B+ M8, Terminal W, Grooves 8, Pulley SP, Fan EF
 A: 84.00 B: 56.00 mm



112076 Alternator 28 V, 80 Amp
 Replacing: AAN3120, 11.209.445
 Servicing: Iveco, Renault V.I., Scania
 B+ M8, Terminal W, Pulley w/o, Fan EF
 B: 27.00 C: 72.10 mm



112097 Alternator 28 V, 30 Amp
 Replacing: AAK3564, AAK1209, AAK1110, 11.201.468, 11.201.075, 11.201.055
 Servicing: Allis Chalmers, Astra, Fahr, Iveco, Laverda
 B+ M6, Grooves 1, Pulley P, Fan w/o
 A: 45.00 B: 17.00 C: 63.00 mm

112098 Alternator 14 V, 65 Amp

Replacing: AAK4351, AAK4313, AAK3547, AAK1370, AAK1182, 11.203.415, 11.203.301, 11.201.499, 11.201.444

Servicing: Case, Claas, Eicher, Iveco, Lamborghini, Mercedes-Benz, NSU, Steyr, Zetor

B+ M6, Terminal W, Grooves 1, Pulley P, Fan EF

A: 77.00 B: 56.00 mm

112159 Alternator 28 V, 80 Amp

Replacing: AAN3108, 11.209.417

Servicing: DAF, MAN, Mercedes-Benz, Renault V.I.

B+ M8, Terminal W, Pulley w/o, Fan EF
B: 80.40 mm

112302 Alternator 28 V, 120 Amp

Replacing: AAT1385, 11.209.448

Servicing: Iveco

B+ M8, Pulley w/o, Fan EF, Not Insulated return
B- M8.

B: 16.00 C: 86.00 mm

112343 Alternator 28 V, 140 Amp

Replacing: AAT1330, AAT1310, 11.203.232, 11.201.902

Servicing: Renault V.I., Scania, Volvo

B+ M8, Terminal W, Pulley w/o, Fan EF
B- M8. Shaft 30 mm.

B: 15.30 C: 182.00 mm

112345 Alternator 28 V, 55 Amp

Replacing: AAN3116, 11.209.436

Servicing: Volvo

B+ M8, Terminal W, Pulley w/o, Fan w/o

B: 51.50 mm



112424 Alternator 28 V, 140 Amp

Replacing: AAT1335, 11.203.237

Servicing: Scania

B+ M8, Pulley w/o, Fan EF
B- M8. Shaft 30 mm.

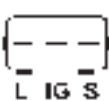
B: 15.50 C: 182.00 mm

112427 Alternator 28 V, 90 Amp

Replacing: AAN5795, 11.209.454

Servicing: Iveco

B+ M8, Grooves 12, Pulley SP, Fan IF

A: 90.00 B: 57.60 mm

112529 Alternator 14 V, 90 Amp

Replacing: AAK5391, AAK5382, AAK5306, 11.203.186, 11.203.167, 11.203.005

Servicing: Daewoo, John Deere, Mercedes-Benz, Ssangyong

B+ M8, Terminal W, Grooves 6, Pulley SP, Fan IF

A: 92.00 B: 56.10 mm

112561 Alternator 28 V, 80 Amp

Replacing: AAN3119, AAN3111, 11.209.442, 11.209.421

Servicing: Mercedes-Benz

B+ M8, Terminal W, Pulley w/o, Fan EF
B: 80.00 mm

112736 Alternator 14 V, 65 Amp

Replacing: AAK1378, 11.201.570

Servicing: Deutz-Fahr, Fahr, Iveco

B+ M6, Terminal W, Grooves 1, Pulley P, Fan EF

A: 76.50 B: 56.10 mm

112747 Alternator 28 V, 55 Amp

Replacing: AAK5734, AAK3318, 11.203.655, 11.201.903

Servicing: Deutz-Fahr, Ford, Iveco, KHD

B+ M8, Terminal W, Pulley w/o, Fan EF
B: 56.00 mm

112757 Alternator 28 V, 55 Amp

Replacing: AAN3115, 11.209.435

Servicing: Scania, Volvo

B+ M8, Terminal W, Pulley w/o, Fan EF
Bosch 0 120 469 963 = Insulated, HC-CARGO 112757 is not insulated

B: 27.50 C: 68.00 mm



112803 Alternator 28 V, 80 Amp

Replacing: AAN3107, 11.209.416

Servicing: Volvo

B+ M8, Terminal W, Pulley w/o, Fan EF

B: 51.00 mm



113376 Alternator 14 V, 55 Amp

Replacing: AAK4143, AAK3130, AAK1181, AAK1131, 11.201.928, 11.201.309, 11.201.214

Servicing: Bedford, Opel, Vauxhall

B+ M6, Terminal W, Grooves 1, Pulley P, Fan EF

A: 76.60 B: 56.20 mm



113448 Alternator 28 V, 100 Amp

Replacing: AAN3112, AAN0112, 11.209.422

Servicing: Mercedes-Benz

B+ M8, Terminal W, Pulley w/o, Fan EF

B: 80.00 mm



113470 Alternator 28 V, 35 Amp

Replacing: AAK4531, AAK4348, AAK3820, AAK1337, 11.204.052, 11.203.404, 11.201.586, 11.201.479

Servicing: Iveco, KHD, Liebherr

B+ M6, Terminal W, Grooves 1, Pulley P, Fan w/o

A: 77.00 B: 55.80 mm



113477 Alternator 28 V, 55 Amp

Replacing: AAK3334, AAK1383, 11.201.939, 11.201.746

Servicing: DAF, Volvo, Volvo BM, Volvo Penta

B+ M6, Terminal W, Pulley w/o, Fan EF, Insulated return

B: 50.80 mm



113768 Alternator 14 V, 95 Amp

Manufacturer: Iskra/Mahle

Replacing: AAK5794, AAK5567, AAK5566, AAK5336, AAK5335, AAK5141, 11.204.037, 11.203.398, 11.203.397

Servicing: Mercedes-Benz, Ssangyong

B+ M8, Terminal W, Pulley w/o

Dust proof.

B: 56.00 mm



113920 Alternator 28 V, 35 Amp

Replacing: AAK1368, 11.201.709

Servicing: MAN, Mercedes-Benz, Padane

B+ M8, Terminal W, Pulley w/o,

Fan w/o

B: 80.40 mm



114465 Alternator 14 V, 70 Amp

Replacing: AAK3339, 11.201.945

Servicing: Volvo BM

B+ M8, Grooves 1, Pulley P, Fan EF

Dust proof.

A: 76.00 B: 51.00 mm



110801 Alternator 28 V, 45 Amp

Replacing: A0012303JB, 2303JB

Servicing: Atlas Copco, Case, Caterpillar, Cummins, Fiat-Allis, International

B+ 1/4" UNF, Terminal W, Pulley w/o, Fan EF

B: 14.80 C: 100.00 mm



112159 Alternator 28 V, 80 Amp

Replacing: BCA3920

Servicing: DAF, MAN, Mercedes-Benz, Renault V.I.

B+ M8, Terminal W, Pulley w/o, Fan EF

B: 80.40 mm



113651 Alternator 14 V, 160 Amp

Replacing: A0012700LC, A0012700JB, A0012670LC, A0012670JB, A001090557, A001090550, A001090546, A001090524

Servicing: Various Industrial applications

B+ M8, Pulley w/o, Fan EF, Insulated return

B: 13.80 C: 103.30 mm



113740[#] Alternator 14 V, 160 Amp

Replacing: A0012800JB, 2800JB, 2800J

Servicing: Caterpillar, Deutz-Fahr, Ford, International, Various, Volvo

B+ 5/16" UNC, Grooves 2, Pulley DP, Fan EF

A: 45.00 B: 14.85 C: 101.25 mm



115387 alternator 28 V, 140 Amp

Replacing: BLP3317A, BLP3317

Servicing: Various Agriculture Vehicles, Various Industrial applications

B+ 5/16" UNF, Fan EF, Insulated return

B: 80.00 mm

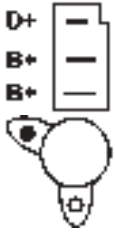

110178 Alternator 14 V, 36 Amp

Manufacturer: Lucas

Replacing: 54022165, 54022083, 54022032, 54022017, 54022006, 54021993, 54021918, 54021917, 54021898, 54021868

Servicing: Austin, Bedford, Case, Ford, Jensen, Land Rover, Lotus, Massey Ferguson, MG, Morris, New Holland, Plymouth, Talbot

B+ 9.40, Pulley w/o, Fan EF

B: 10.00 C: 87.00 mm

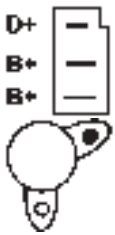

110179 Alternator 14 V, 36 Amp

Manufacturer: Lucas

Replacing: 54022084, 54022011, 54021985, 54021845, 54021810, 54021493, 24180, 24153, 24141, 24133, 24108

Servicing: Bedford, Case, Ford, Jaguar, Land Rover, LDV International, Lotus, Mercury, Triumph, Vauxhall

B+ 9.40, Pulley w/o, Fan EF

For pulley w/ 17.00 mm bore use bushing: HC-CARGO 134894.

B: 9.75 C: 88.00 mm

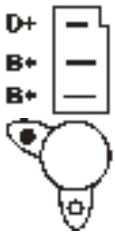

110759 Alternator 14 V, 35 Amp

Replacing: 61920312

Servicing: Austin, Ford, Mercury

B+ 9.40, Grooves 1, Pulley P, Fan EF

A: 36.15 B: 10.50 C: 79.00 mm



110766 Alternator 28 V, 27 Amp

Replacing: A0924

Servicing: Atlas Copco, Case, Deutz-Fahr, Iveco, KHD, Liebherr, Magirus-Deutz, Mercedes-Benz, Steyr

B+ M6, Terminal W, Pulley w/o, Fan EF

B: 56.00 mm

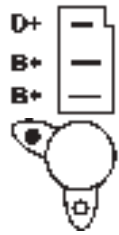

111289 Alternator 14 V, 70 Amp

Replacing: 61920314, 61920311, 54022620, 54022572, 54022243, 54022147, 54021921, 54021919, 24318, 24199, 24181

Servicing: Austin, Case, Dronningborg, Ford, Land Rover, Massey Ferguson, MG, Morris, Rover

B+ 9.40, Terminal W, Grooves 1, Pulley P, Fan EF

A: 35.00 B: 12.50 C: 80.00 mm



111569 Alternator 28 V, 30 Amp

Replacing: 54022711, 54022619, 54022578, 54022415, 24413, 24406, 24299

Servicing: DAF, LDV International

B+ M6, Terminal W, Pulley w/o, Fan w/o

B: 11.70 C: 82.80 mm

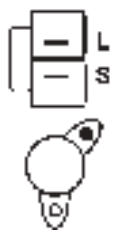

111956 Alternator 14 V, 75 Amp

Replacing: LRA0469

Servicing: Mitsubishi

B+ M8, Grooves 2, Pulley DP, Fan IF

A: 41.00 B: 13.00 C: 55.00 mm



112097 Alternator 28 V, 30 Amp

Replacing: LRA2378, A0828, 61920271

Servicing: Allis Chalmers, Astra, Fahr, Iveco, Laverda

B+ M6, Grooves 1, Pulley P, Fan w/o

A: 45.00 B: 17.00 C: 63.00 mm



112238 Alternator 14 V, 65 Amp

Replacing: 54022663, 54022646, 54022591, 54022552, 54022510, 54022393, 54022268, 54022267, 54022256, 54022220

Servicing: Austin, DAF, Land Rover, LDV, Rover

B+ M6, Terminal W, Grooves 1, Pulley P, Fan EF

A: 36.00 B: 11.50 C: 81.70 mm



112529 Alternator 14 V, 90 Amp

Replacing: LRA1860

Servicing: Daewoo, John Deere, Mercedes-Benz, Ssangyong

B+ M8, Terminal W, Grooves 6, Pulley SP, Fan IF

A: 92.00 B: 56.10 mm



113376 Alternator 14 V, 55 Amp

Replacing: 61920201

Servicing: Bedford, Opel, Vauxhall

B+ M6, Terminal W, Grooves 1, Pulley P, Fan EF

A: 76.60 B: 56.20 mm

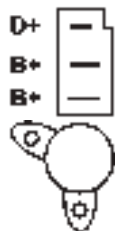

113378 Alternator 14 V, 45 Amp

Replacing: 61920286, 54021879, 24211A, 24079A, 24079, 24072, 23993, 23846, 23845, 23830, 23814, 23807, 23740

Servicing: Austin, Ford, Land Rover

B+ 9.40, Terminal S, Pulley w/o, Fan w/o

B: 9.10 C: 87.80 mm



113920 Alternator 28 V, 35 Amp

Replacing: 24271

Servicing: MAN, Mercedes-Benz, Padane

B+ M8, Terminal W, Pulley w/o, Fan w/o

B: 80.40 mm

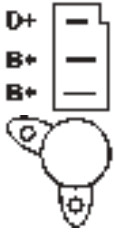

110923 Alternator 14 V, 55 Amp

Replacing: 943356621

Servicing: Mercedes-Benz

B+ Plug, Grooves 6, Pulley SP, Fan EF

A: 92.00 B: 56.00 mm

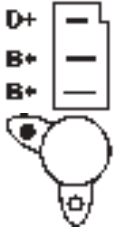

111289 Alternator 14 V, 70 Amp

Replacing: 943358010, 943356639,
943356633, 63358020, 63358010

Servicing: Austin, Case, Dronningborg, Ford,
Land Rover, Massey Ferguson, MG, Morris,
Rover

B+ 9.40, Terminal W, Grooves 1,
Pulley P, Fan EF

A: 35.00 B: 12.50 C: 80.00 mm



112097 Alternator 28 V, 30 Amp

Replacing: 943320025, 63321163, 63321161,
63321115, 63321104, 63321063, 63321055,
63321052, 63321050, 63321049

Servicing: Allis Chalmers, Astra, Fahr, Iveco,
Laverda

B+ M6, Grooves 1, Pulley P, Fan w/o

A: 45.00 B: 17.00 C: 63.00 mm



112238 Alternator 14 V, 65 Amp

Replacing: 63324242

Servicing: Austin, DAF, Land Rover, LDV,
Rover

B+ M6, Terminal W, Grooves 1,
Pulley P, Fan EF

A: 36.00 B: 11.50 C: 81.70 mm



110163 Alternator 28 V, 45 Amp

Replacing: 443113516866

Servicing: Renault V.I.

B+ M6, Terminal W, Grooves 2,
Pulley DP, Fan EF

A: 48.75 B: 27.25 C: 67.50 mm



111009 Alternator 28 V, 35 Amp

Manufacturer: Magneton

Replacing: 9515836, 443113516846,
443113516842, 443113516836

Servicing: Porsche, Tatra

B+ M6, Terminal W, Grooves 1,
Pulley P, Fan EF

A: 51.70 B: 27.25 C: 66.00 mm

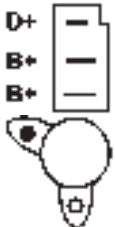

111289 Alternator 14 V, 70 Amp

Replacing: 9516742, 9516740, 9516709,
9515734

Servicing: Austin, Case, Dronningborg, Ford,
Land Rover, Massey Ferguson, MG, Morris,
Rover

B+ 9.40, Terminal W, Grooves 1,
Pulley P, Fan EF

A: 35.00 B: 12.50 C: 80.00 mm



112098 Alternator 14 V, 65 Amp

Replacing: 9516693, 9515010, 9513031,
443113516693, 443113516690

Servicing: Case, Claas, Eicher, Iveco,
Lamborghini, Mercedes-Benz, NSU, Steyr,
Zetor

B+ M6, Terminal W, Grooves 1,
Pulley P, Fan EF

A: 77.00 B: 56.00 mm



112238 Alternator 14 V, 65 Amp

Replacing: 9515040

Servicing: Austin, DAF, Land Rover, LDV,
Rover

B+ M6, Terminal W, Grooves 1,
Pulley P, Fan EF

A: 36.00 B: 11.50 C: 81.70 mm



112736 Alternator 14 V, 65 Amp

Replacing: 9515230

Servicing: Deutz-Fahr, Fahr, Iveco

B+ M6, Terminal W, Grooves 1,
Pulley P, Fan EF

A: 76.50 B: 56.10 mm

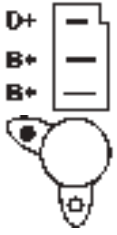

110178 Alternator 14 V, 36 Amp
 Manufacturer: Lucas
 Replacing: AH2140B14
 Servicing: Austin, Bedford, Case, Ford, Jensen, Land Rover, Lotus, Massey Ferguson, MG, Morris, New Holland, Plymouth, Talbot
 B+ 9.40, Pulley w/o, Fan EF
 B: 10.00 C: 87.00 mm

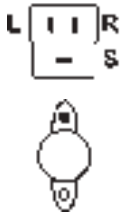

110702[#] Alternator 14 V, 70 Amp
 Replacing: A2T25377, A002T25377
 Servicing: Nissan
 B+ M6, Grooves 1, Pulley P, Fan EF
 A: 42.25 B: 13.30 C: 80.45 mm

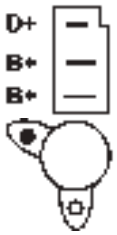

110759 Alternator 14 V, 35 Amp
 Replacing: AQ2140C4, AQ2140C, AH2040C
 Servicing: Austin, Ford, Mercury
 B+ 9.40, Grooves 1, Pulley P, Fan EF
 A: 36.15 B: 10.50 C: 79.00 mm



110805 Alternator 14 V, 45 Amp
 Replacing: MD304139, MD096859, MD095741, MD086016, MD086015, MD070310, MD069859, MD068565, MD067411, MD060793
 Servicing: Dodge, Mazda, Mitsubishi, Plymouth
 B+ M5, Grooves 1, Pulley P, Fan EF
 A: 45.30 B: 13.10 C: 54.20 mm

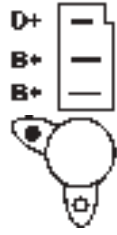

111289 Alternator 14 V, 70 Amp
 Replacing: A5T31774, A5T31773, A5T31772, A5T31372, A005T31774, A005T31773, A005T31772, A005T31372
 Servicing: Austin, Case, Dronningborg, Ford, Land Rover, Massey Ferguson, MG, Morris, Rover
 B+ 9.40, Terminal W, Grooves 1, Pulley P, Fan EF
 A: 35.00 B: 12.50 C: 80.00 mm

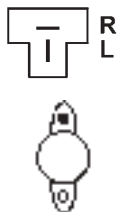

111344 Alternator 28 V, 25 Amp
 Replacing: ME017561, ME017560, ME017550, ME017509, ME007578, A5T70283, A5T70270, A5T70183, A5T70178, A2T71583
 Servicing: Mitsubishi
 B+ M5, Grooves 1, Pulley P, Fan EF
 A: 45.25 B: 12.55 C: 80.20 mm



111720 Alternator 28 V, 90 Amp
 Replacing: A4TR5191ZT, A4TR5191, A004TR5191ZT
 Servicing: Scania
 B+ M8, Terminal W, Pulley w/o, Fan w/o
 B: 22.70 C: 68.70 mm

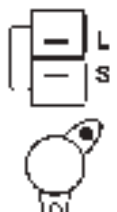

111956 Alternator 14 V, 75 Amp
 Replacing: ME202971, ME201838, ME200698, ME200696, A3TB1299, A3T09699, A3T09698, A3T09199, A3T08699
 Servicing: Mitsubishi
 B+ M8, Grooves 2, Pulley DP, Fan IF
 A: 41.00 B: 13.00 C: 55.00 mm



112210 Alternator 28 V, 30 Amp
 Replacing: ME017562, A2T72383, A002T72383
 Servicing: Mitsubishi
 B+ M6, Grooves 1, Pulley P, Fan IF
 A: 44.00 B: 13.30 C: 80.90 mm

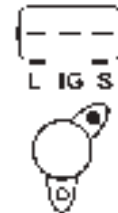

112427 Alternator 28 V, 90 Amp
 Replacing: A4TA8492, A4TA8292, A4TA8291, A4TA0592, A004TA8492, A004TA8292, A004TA8291, A004TA0592
 Servicing: Iveco
 B+ M8, Grooves 12, Pulley SP, Fan IF
 A: 90.00 B: 57.60 mm



113506 Alternator 28 V, 40 Amp
 Replacing: ME017615, A3TN5288, A003TN5288
 Servicing: Mitsubishi
 B+ M8, Terminal W, Grooves 2, Pulley DP, Fan EF
 A: 43.00 B: 13.10 C: 81.60 mm

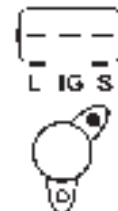

113923 Alternator 28 V, 90 Amp
 Replacing: A4TA8491, A4TA0591, A004TA8491, A004TA0591
 Servicing: Iveco
 B+ M8, Grooves 10, Pulley SP, Fan IF, Not Insulated return
 A: 90.00 B: 58.10 mm



114244 Alternator 14 V, 130 Amp

Replacing: A3TG2681ZE, A3TG2681AE, A3TG2681, A003TG2681ZE, A003TG2681AE, A003TG2681

Servicing: Nissan, Renault V.I.

B+ M8, Pulley w/o, Fan IF

Freewheel Pulley: HC-CARGO 330341.

B: 13.00 C: 81.00 mm



NEW PRODUCT
www.hc-cargo.com

114303 Alternator 28 V, 100 Amp

Replacing: A4TA8591, A4TA8191, A3TA8791, A004TA8591, A004TA8191

Servicing: Renault V.I., Volvo

B+ M8, Grooves 10, Pulley SP, Fan IF

A: 82.50 B: 56.00 mm



114407 Alternator 28 V, 90 Amp

Replacing: A4TR5391ZT, A4TR5391, A004TR5391ZT, A004TR5391

Servicing: Renault V.I.

B+ M8, Grooves 8, Pulley SP, Fan IF, Not Insulated return

A: 44.50 B: 13.80 C: 101.00 mm



114424 Alternator 14 V, 80 Amp

Replacing: ME015237, A4TU0088, A004TU0088

Servicing: Mitsubishi

B+ M8x1.25, Grooves 2, Pulley DP, Fan EF



114425 Alternator 28 V, 50 Amp

Replacing: ME077790, A4T40386, A004T40386

Servicing: Mitsubishi

B+ M8, Terminal W, Grooves 2, Pulley DP, Fan EF

A: 42.00 B: 14.00 C: 81.00 mm

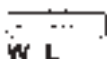

114508 Alternator 28 V, 90 Amp

Replacing: A4TR5091ZT

Servicing: Opel, Renault V.I.

B+ M8, Terminal W, Grooves 5, Pulley SP, Fan IF

A: 81.00 B: 27.00 C: 65.00 mm

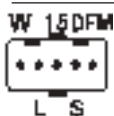

NEW PRODUCT
www.hc-cargo.com

114753* Alternator 28 V, 100 Amp

Replacing: A4TR5491ZT, A4TR5491AT, A4TR5491, A004TR5491AT, A004TR5491

Servicing: Scania

Terminal W, Grooves 8, Pulley SP, Fan IF

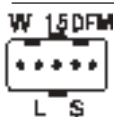

NEW PRODUCT
www.hc-cargo.com

114846* Alternator 28 V, 130 Amp

Replacing: A4TR5891ZT, A4TR5891, A004TR5891ZT

Grooves 8, Pulley SP, Fan IF

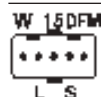

NEW PRODUCT
www.hc-cargo.com

114861 Alternator 28 V, 100 Amp

Replacing: A4TR5291ZT, A4TR5291AT, A4TR5291, A004TR5291ZT, A004TR5291AT, A004TR5291

Servicing: Scania

B+ M8, Terminal W, Grooves 8, Pulley SP, Fan IF

A: 20.00 B: 85.00 C: 35.50 mm

NEW PRODUCT
www.hc-cargo.com

114880* Alternator 28 V, 110 Amp

Replacing: A4TR5592ZT, A4TR5592, A4TR5591ZT, A4TR5591, A004TR5592ZT, A004TR5592, A004TR5591ZT, A004TR5591

Grooves 8, Pulley SP, Fan IF

115454* Alternator 14 V, 40 Amp

Replacing: A2TA8191ZT, A2TA8191, A002TA8191ZT, A002TA8191

Servicing: Citroen, Renault V.I.

Grooves 2, Pulley DP, Fan IF

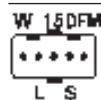

NEW PRODUCT
www.hc-cargo.com

115577* Alternator 28 V, 80 Amp

Replacing: A4TR5392ZT, A4TR5392, A004TR5392ZT, A004TR5392

Servicing: Renault V.I., Volvo

Pulley w/o, Fan IF

NEW PRODUCT
www.hc-cargo.com

115586* Alternator 28 V

Replacing: A9TU6499

Grooves 10, Pulley SP, Fan EF



110076# Alternator 28 V, 55 Amp
 Replacing: 9ar6025k, 510-445
 Servicing: Pegaso, Scania
 B+ M6, Terminal W, Pulley w/o,
 Fan w/o
 B: 80.00 mm



110112 Alternator 28 V, 40 Amp
 Replacing: 9ar3921g, 510-348, 510-347
 Servicing: Volvo, Volvo Penta
 B+ M6, Terminal W, Pulley w/o,
 Fan w/o
 B: 51.00 mm



110113 Alternator 28 V, 27 Amp
 Replacing: 9ar3927g, 510-372
 Servicing: Mercedes-Benz
 B+ M6, Pulley w/o, Fan EF
 B: 80.00 mm



110116 Alternator 28 V, 35 Amp
 Replacing: 9ar3987g, 510-397
 Servicing: DAF, Ford, MAN
 B+ M8, Terminal W, Pulley w/o,
 Fan w/o
 B: 80.00 mm



110117 Alternator 28 V, 35 Amp
 Manufacturer: Valeo
 Replacing: 9AR6012G, 9AR6012, 510-427
 Servicing: Iveco, Magirus-Deutz, Steyr,
 Various Agriculture Vehicles
 B+ M6, Pulley w/o, Fan EF
 B: 56.00 mm



110163 Alternator 28 V, 45 Amp
 Replacing: 9AR3961, 9AR3806G, 510-388
 Servicing: Renault V.I.
 B+ M6, Terminal W, Grooves 2,
 Pulley DP, Fan EF
 A: 48.75 B: 27.25 C: 67.50 mm

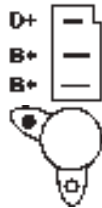

110178 Alternator 14 V, 36 Amp
 Manufacturer: Lucas
 Replacing: 9AR2916F, 9AR2916, 9AR2915F,
 510-105, 510-104, 2541194
 Servicing: Austin, Bedford, Case, Ford,
 Jensen, Land Rover, Lotus, Massey Ferguson,
 MG, Morris, New Holland, Plymouth, Talbot
 B+ 9.40, Pulley w/o, Fan EF
 B: 10.00 C: 87.00 mm

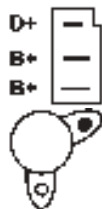

110179 Alternator 14 V, 36 Amp
 Manufacturer: Lucas
 Replacing: 9AR5019, 9AR2877, 9AR2603G,
 9AR2603F, 9AR2603
 Servicing: Bedford, Case, Ford, Jaguar, Land
 Rover, LDV International, Lotus, Mercury,
 Triumph, Vauxhall
 B+ 9.40, Pulley w/o, Fan EF
 For pulley w/ 17.00 mm bore use bushing:
 HC-CARGO 134894.
 B: 9.75 C: 88.00 mm

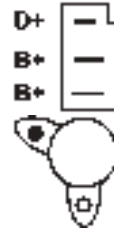

110759 Alternator 14 V, 35 Amp
 Replacing: 9AR2895F, 9AR2895, 9AR2703F,
 9AR2698F, 9AR2627G, 9AR2627, 9AR2613F,
 9AR2613, 9AR2612G, 9AR2612
 Servicing: Austin, Ford, Mercury
 B+ 9.40, Grooves 1, Pulley P, Fan EF
 A: 36.15 B: 10.50 C: 79.00 mm



110766 Alternator 28 V, 27 Amp
 Replacing: 9AR6015K
 Servicing: Atlas Copco, Case, Deutz-Fahr,
 Iveco, KHD, Liebherr, Magirus-Deutz,
 Mercedes-Benz, Steyr
 B+ M6, Terminal W, Pulley w/o, Fan EF
 B: 56.00 mm

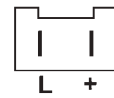

110889 Alternator 14 V, 75 Amp
 Replacing: 9AR2950P
 Servicing: Renault, Renault V.I.
 B+ M6, Terminal W, Grooves 1,
 Pulley P, Fan EF
 A: 57.90 B: 26.90 C: 69.00 mm



111141 Alternator 14 V, 55 Amp
 Replacing: 2940793
 Servicing: MAN, Mercedes-Benz
 B+ M6, Terminal W, Pulley w/o,
 Fan w/o
 B: 80.00 mm

111289 Alternator 14 V, 70 Amp

Replacing: 9AR5092K, 9AR5022G, 9AR5022, 9AR2978, 9AR2843G, 9AR2707G, 9AR2703, 9AR2701, 9AR2700G, 9AR2700

Servicing: Austin, Case, Dronningborg, Ford, Land Rover, Massey Ferguson, MG, Morris, Rover

B+ 9.40, Terminal W, Grooves 1, Pulley P, Fan EF

A: 35.00 B: 12.50 C: 80.00 mm

111419 Alternator 28 V, 55 Amp

Replacing: 2541423

Servicing: Allis Chalmers, BENFRA, Fiat-Allis, Iveco, Laverda

B+ M8, Terminal W, Grooves 2, Pulley DP, Fan EF

A: 50.00 B: 17.45 C: 63.00 mm

112097 Alternator 28 V, 30 Amp

Replacing: 9AR3952G, 9AR3952, 9AL3955G

Servicing: Allis Chalmers, Astra, Fahr, Iveco, Laverda

B+ M6, Grooves 1, Pulley P, Fan w/o

A: 45.00 B: 17.00 C: 63.00 mm

113376 Alternator 14 V, 55 Amp

Replacing: 9AR2904L, 9AR2904K, 9AR2904

Servicing: Bedford, Opel, Vauxhall

B+ M6, Terminal W, Grooves 1, Pulley P, Fan EF

A: 76.60 B: 56.20 mm

113477 Alternator 28 V, 55 Amp

Replacing: 2940060

Servicing: DAF, Volvo, Volvo BM, Volvo Penta B+ M6, Terminal W, Pulley w/o, Fan EF, Insulated return

B: 50.80 mm



113739 Alternator 14 V, 130 Amp

Replacing: 110-800

Servicing: Caterpillar, Ford, International, Various, Volvo

B+ M8, Pulley w/o, Fan EF Rotor shaft 7/8" (22.23 mm).

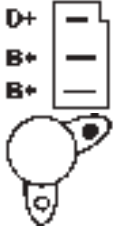
B: 13.00 C: 102.00 mm



110179 Alternator 14 V, 36 Amp

Manufacturer: Lucas

Replacing: 8HA2009KA

Servicing: Bedford, Case, Ford, Jaguar, Land Rover, LDV International, Lotus, Mercury, Triumph, Vauxhall

B+ 9.40, Pulley w/o, Fan EF

For pulley w/ 17.00 mm bore use bushing: HC-CARGO 134894.

B: 9.75 C: 88.00 mm



112159 Alternator 28 V, 80 Amp

Replacing: MDA3920

Servicing: DAF, MAN, Mercedes-Benz, Renault V.I.

B+ M8, Terminal W, Pulley w/o, Fan EF

B: 80.40 mm



113739 Alternator 14 V, 130 Amp

Replacing: 8LHA2070VB, 8LHA2070VA, 8LHA2070V, 110-555

Servicing: Caterpillar, Ford, International, Various, Volvo

B+ M8, Pulley w/o, Fan EF

Rotor shaft 7/8" (22.23 mm).

B: 13.00 C: 102.00 mm



114349 Alternator 28 V, 150 Amp

Replacing: 8SC3238VC

Servicing: Cummins, Xichai-Fawd

B+ 5/16" UNC, Pulley w/o

B: 14.00 C: 101.00 mm



114430 Alternator 14 V, 175 Amp

Replacing: 8LHP2276V, 110-775P

Servicing: Freightliner

B+ 5/16" UNF, Pulley w/o, Fan EF, Insulated return

B: 80.00 mm



114414 Alternator 28 V, 55 Amp

Replacing: 02142-5070

Servicing: Hino, Nissan

B+ M6, Grooves 2, Pulley DP

A: 49.90 B: 14.20 C: 89.90 mm



110895 Alternator 28 V, 55 Amp
 Replacing: AELB697, 859232
 Servicing: DAF, Kässbohrer, MAN, Mercedes-Benz, Ssangyong
 B+ M8, Terminal W, Pulley w/o, Fan EF
 B: 80.00 mm



112159 Alternator 28 V, 80 Amp
 Replacing: 110-872
 Servicing: DAF, MAN, Mercedes-Benz, Renault V.I.
 B+ M8, Terminal W, Pulley w/o, Fan EF
 B: 80.40 mm

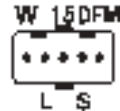

113351 Alternator 28 V, 100 Amp
 Replacing: 860807
 Servicing: Mercedes-Benz
 B+ M8, Terminal W, Pulley w/o, Fan IF
 B: 80.00 mm



111808# Alternator 28 V, 120 Amp
 Replacing: 1285515
 Servicing: Volvo
 B+ M10, Terminal W, Pulley w/o, Fan EF



112189 Alternator 28 V, 80 Amp
 Replacing: 860561
 Servicing: Renault V.I.
 B+ M8, Terminal W, Pulley w/o, Fan EF, Insulated return
 B: 27.00 C: 71.25 mm

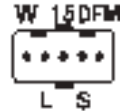

113998 Alternator 28 V, 110 Amp
 Replacing: 860808
 Servicing: MAN
 B+ M8, Terminal W, Pulley w/o, Fan IF
 B: 79.50 mm



111886 Alternator 28 V, 65 Amp
 Replacing: 860557
 Servicing: Scania
 B+ M8, Terminal W, Pulley w/o, Fan w/o
 B: 23.25 C: 68.70 mm



112343 Alternator 28 V, 140 Amp
 Replacing: 1277700
 Servicing: Renault V.I., Scania, Volvo
 B+ M8, Terminal W, Pulley w/o, Fan EF
 B- M8. Shaft 30 mm.
 B: 15.30 C: 182.00 mm

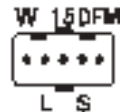

114212 Alternator 28 V, 110 Amp
 Replacing: 860804
 Servicing: Renault V.I., Volvo
 B+ M8, Pulley w/o, Fan IF
 B: 13.50 C: 106.00 mm



112097 Alternator 28 V, 30 Amp
 Replacing: 860141
 Servicing: Allis Chalmers, Astra, Fahr, Iveco, Laverda
 B+ M6, Grooves 1, Pulley P, Fan w/o
 A: 45.00 B: 17.00 C: 63.00 mm



112345 Alternator 28 V, 55 Amp
 Replacing: 858884
 Servicing: Volvo
 B+ M8, Terminal W, Pulley w/o, Fan w/o
 B: 51.50 mm



114374 Alternator 28 V, 110 Amp
 Replacing: JFZ2110A2
 Servicing: Cummins
 B+ 3/16" UNF, Grooves 2, Pulley DP
 A: 50.00 B: 16.20 C: 101.20 mm

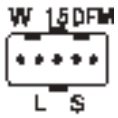

NEW PRODUCT
www.hc-cargo.com

115618* Alternator 28 V, 110 Amp
Manufacturer: Bosch
Replacing: 860809
Servicing: Bova, DAF, Solaris
Fan IF



110112 Alternator 28 V, 40 Amp
 Replacing: 19025074
 Servicing: Volvo, Volvo Penta
 B+ M6, Terminal W, Pulley w/o, Fan w/o
 B: 51.00 mm



110300 Alternator 28 V, 65 Amp
 Replacing: 321-654, 1105476, 1105475, 1105474, 1100274, 1100211, 1100093, 1100077, 10463160
 Servicing: Case, International
 B+ M6, Terminal W, Pulley w/o, Fan EF
 Replacing: 27SI. Shaft dia. 22.00 mm. Fan: HC-CARGO 131854. Self exiting function
 B: 11.90 C: 103.00 mm



110504 Alternator 14 V, 90 Amp
 Replacing: 1105073, 1102875, 1100589
 Servicing: Buick, Case, Chevrolet, Fiat-Allis, International, Jeep
 B+ M6, Terminal W, Pulley w/o, Fan EF
 Same as HC-CARGO 110505 (75 A).
 B: 51.00 mm



110544 Alternator 28 V, 125 Amp
 Manufacturer: Remy
 Replacing: 19025347, 19025304
 Servicing: Ikarus
 B+ M8, Terminal W, Grooves 2, Pulley DP, Fan EF
 Saddle mounting.



110801 Alternator 28 V, 45 Amp
 Replacing: 321-665, 321-660, 1117655, 1117650, 1117647, 1117645, 1117644, 1117643, 1117642, 1117640, 1117623
 Servicing: Atlas Copco, Case, Caterpillar, Cummins, Fiat-Allis, International
 B+ 1/4" UNF, Terminal W, Pulley w/o, Fan EF
 B: 14.80 C: 100.00 mm

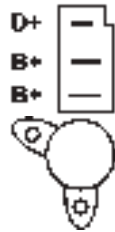

110923 Alternator 14 V, 55 Amp
 Replacing: 19025069
 Servicing: Mercedes-Benz
 B+ Plug, Grooves 6, Pulley SP, Fan EF
 A: 92.00 B: 56.00 mm



111232 Alternator 14 V, 115 Amp
 Replacing: 19010212, 19010192, 19010189, 19010179, 19010176, 19010175, 19010174, 19010173, 19010172, 19010171
 Servicing: International, Volvo
 B+ 1/4" UNF, Terminal W, Pulley w/o, Fan EF
 Replacing: 21SI. One wire system. B+ 1/4".
 B: 14.30 C: 101.80 mm



111833 Alternator 28 V, 140 Amp
 Replacing: 19025330
 Servicing: Drögmöller, Mercedes-Benz, Setra, Various Agriculture Vehicles
 B+ M8, Terminal W, Pulley w/o, Fan EF
 B- M8. Shaft 30 mm. Heavy duty type: HC-CARGO 113589. 180 A.
 B: 15.70 C: 182.00 mm



111834 Alternator 28 V, 55 Amp
 Replacing: 1117252
 Servicing: Scania
 B+ M8, Terminal W, Pulley w/o, Fan EF
 Heavy duty type: HC-CARGO 112182 (80 A).
 B: 80.00 mm



111842 Alternator 28 V, 140 Amp
 Replacing: 19025333
 Servicing: Ikarus, MAN, Mercedes-Benz, Neoplan
 B+ M8, Terminal W, Pulley w/o, Fan EF
 B- M8. Shaft 30 mm.
 B: 15.00 C: 180.00 mm



111886 Alternator 28 V, 65 Amp
 Replacing: 19025114
 Servicing: Scania
 B+ M8, Terminal W, Pulley w/o, Fan w/o
 B: 23.25 C: 68.70 mm



112076 Alternator 28 V, 80 Amp
 Replacing: 19025101
 Servicing: Iveco, Renault V.I., Scania
 B+ M8, Terminal W, Pulley w/o, Fan EF
 B: 27.00 C: 72.10 mm



112097 Alternator 28 V, 30 Amp
 Replacing: 19025057, 19025044
 Servicing: Allis Chalmers, Astra, Fahr, Iveco, Laverda
 B+ M6, Grooves 1, Pulley P, Fan w/o
 A: 45.00 B: 17.00 C: 63.00 mm



112159 Alternator 28 V, 80 Amp
 Replacing: 19025107, 19025100
 Servicing: DAF, MAN, Mercedes-Benz, Renault V.I.
 B+ M8, Terminal W, Pulley w/o, Fan EF
 B: 80.40 mm



112260[#] Alternator 14 V, 80 Amp
 Replacing: 321-603, 1105470, 1105469, 1105467, 1105465, 1105464, 1105463, 1105462, 1105460, 1102553, 1101289
 Servicing: Allis Chalmers, Case, Chevrolet, Cummins, International, Volvo
 B+ M5, Pulley w/o, Fan w/o
 Replacing: 27SI. Negative grounding.
 B: 12.60 C: 103.45 mm



112264[#] Alternator 14 V, 105 Amp
 Replacing: 1117816, 1117813, 1117812, 1117811, 1117809, 1117801
 Servicing: Caterpillar, Cummins, Ford, Freightliner, International, Kenworth, Mack, Volvo
 B+ M6, Pulley w/o, Fan EF
 Replacing: 30SI. Negative grounding.
 B: 14.00 C: 101.60 mm



112424 Alternator 28 V, 140 Amp
 Replacing: 19025339
 Servicing: Scania
 B+ M8, Pulley w/o, Fan EF
 B- M8. Shaft 30 mm.
 B: 15.50 C: 182.00 mm



112561 Alternator 28 V, 80 Amp
 Replacing: 19070058, 19070006, 19025113
 Servicing: Mercedes-Benz
 B+ M8, Terminal W, Pulley w/o, Fan EF
 B: 80.00 mm



P L F S



112641[#] Alternator 14 V, 100/105 Amp
 Replacing: 10479976
 Servicing: Freightliner
 B+ M6, Grooves 8, Pulley SP, Fan EF
 Replacing: CS130.
 A: 37.00 B: 12.00 C: 82.00 mm



112657 Alternator 28 V, 60 Amp
 Replacing: 219072
 Servicing: Various Industrial applications
 B+ M6, Grooves 8, Pulley SP, Fan EF
 One wire hookup (self-exciting) type.
 A: 42.75 B: 14.85 C: 101.00 mm



112824 Alternator 14 V, 145 Amp
 Replacing: 321-739, 19020806, 19020801, 19020377, 19020365, 19020364, 19020359, 19020358, 19020323, 19020303
 Servicing: Freightliner, International, Kenworth, Mack
 B+ 5/16" UNC, Terminal W, Pulley w/o, Fan EF, Not Insulated return
 Replacing: 22SI. Negative grounding. One wire system. R-Terminal universal. I-Terminal 10-24.
 B: 14.10 C: 100.60 mm



112834 Alternator 14 V, 145 Amp
 Replacing: 19020381, 19020379, 19020312, 19020310, 19020308, 19020306, 19020305, 10459472, 10459254, 10459217
 Servicing: Ford, International
 B+ 1/4" UNF, Terminal R, Pulley w/o, Fan EF
 Replacing: 22SI. One wire system. B+ 1/4"-UNC. I-Terminal universal. R-Terminal 10-24.
 B: 13.20 C: 101.50 mm



112989 Alternator 14 V, 60 Amp
 Replacing: 321-666, 1117641, 1117628, 1117621, 1117620, 1117618, 1117613, 1117612, 1117611, 10459200, 10459020
 Servicing: Caterpillar, Chevrolet, Cummins, International, Mack, Massey Ferguson
 B+ M8, Terminal W, Pulley w/o, Fan IF
 Replacing: 20SI. Negative grounding. One wire system. B+ 1/4".
 B: 14.85 C: 101.65 mm



112993 Alternator 14 V, 130 Amp

Replacing: 19010166, 19010163, 19010162, 19010161, 19010160, 19010159, 19010158, 19010157, 19010154, 19010137

Servicing: Cummins, Ford, International, Volvo

B+ 1/4" UNF, Terminal W, Pulley w/o, Fan EF

Replacing: 21SI. Negative grounding. One wire system. B+ 1/4". Shaft is 7/8 In = 22.255 mm

B: 14.20 C: 101.50 mm



112994 Alternator 14 V, 100 Amp

Replacing: 19010181, 19010105, 19010101, 1117905, 1117892, 1117890, 1117887, 1117886, 1117885, 10459301

Servicing: Cummins, Ford, International, Volvo

B+ 5/16" UNC, Pulley w/o, Fan EF

Replacing: 21SI. Negative grounding. One wire system. B+ 5/16".

B: 13.60 C: 100.80 mm



112995 Alternator 14 V, 145 Amp

Replacing: 19010202, 19010168, 19010139, 19010128, 19010127, 19010126, 19010115, 1117964, 1117963, 1117934

Servicing: Kenworth, Mack

B+ M8, Terminal W, Pulley w/o, Fan EF

Replacing: 21SI. Negative grounding. One wire system. B+ 5/16".

B: 14.00 C: 101.00 mm

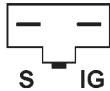

112996 Alternator 14 V, 115 Amp

Replacing: 321-687, 19010207, 19010196, 19010191, 19010188, 19010187, 19010170, 19010150, 19010147, 19010145

Servicing: Caterpillar, Ford, Freightliner, John Deere, Kenworth, Mack, New Holland, Volvo

B+ M8, Pulley w/o, Fan EF

Replacing: 21SI. Negative grounding. One wire system. B+ 1/4".

B: 14.55 C: 100.50 mm



113001[#] Alternator 14 V, 110 Amp

Replacing: 321-734, 321-733, 1901160, 1901158, 19011174, 19011162, 19011160, 19011158, 19011154, 19011151

Servicing: Ford, Freightliner, International, Kenworth, Volvo

B+ 5/16" UNF, Pulley w/o, Fan EF

Replacing: 33SI. Negative grounding. One wire system. B+ 1/4".

B: 14.25 C: 101.00 mm



113002[#] Alternator 14 V, 135 Amp

Replacing: 321-732, 321-731, 19011173, 19011171, 19011163, 19011161, 19011159, 19011156, 19011155, 19011152

Servicing: International, Kenworth, Mack, Volvo

B+ 1/4" UNF, Pulley w/o, Fan EF

Replacing: 33SI. Negative grounding. One wire system. B+ terminal 1/4".

B: 14.00 C: 101.25 mm

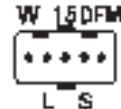

113351 Alternator 28 V, 100 Amp

Replacing: 19070016, 19070015, 19070014, 19070009, 19070008, 19070007

Servicing: Mercedes-Benz

B+ M8, Terminal W, Pulley w/o, Fan IF

B: 80.00 mm



113376 Alternator 14 V, 55 Amp

Replacing: 3493204, 3472204, 3472104, 3472061, 3472049, 3472039, 3472038, 3472024, 3472022

Servicing: Bedford, Opel, Vauxhall

B+ M6, Terminal W, Grooves 1, Pulley P, Fan EF

A: 76.60 B: 56.20 mm



113432 Alternator 14 V, 145 Amp

Replacing: 321-688, 19010156, 1117952, 1117948, 1117933, 1117924, 1117916, 10459051, 10459050

Servicing: International, Kenworth, Mack, Renault Agriculture, Volvo

B+ M6, Terminal W, Pulley w/o, Fan EF

Replacing: 21SI. Negative grounding. One wire system. B+ 1/4".

B: 14.30 C: 101.20 mm



113448 Alternator 28 V, 100 Amp

Replacing: 19025112, 19025111, 19025110, 19025109

Servicing: Mercedes-Benz

B+ M8, Terminal W, Pulley w/o, Fan EF

B: 80.00 mm



113579 Alternator 14 V, 145 Amp

Replacing: 19020889, 19020804, 19020803, 19020389, 19020388, 19020387, 10459321, 10459320, 10459318

Servicing: International, Kenworth, Mack, Volvo

B+ 5/16" UNC, Terminal W, Pulley w/o, Fan EF

Replacing: 22SI.

B: 80.00 C: 108.00 mm



114351 Alternator 14 V, 200 Amp

Replacing: 8600313

Servicing: Caterpillar, Cummins, International

B+ M8, Terminal W, Pulley w/o, Fan IF

B: 14.00 C: 101.20 mm



114359 Alternator 14 V, 170 Amp

Replacing: 8700047, 8700040, 8700039, 8600203, 8600178, 8600171, 8600127, 8600073, 8600060, 8600055, 8600015

Servicing: Sterling, Volvo

B+ 3/16" UNF, Pulley w/o, Fan EF

B: 80.00 C: 126.00 mm



114423 Alternator 28 V, 55 Amp

Replacing: 0201-102-3015

Servicing: Hino

B+ M6, Grooves 2, Pulley DP, Fan EF

A: 51.00 B: 14.00 C: 85.47 mm



110112 Alternator 28 V, 40 Amp

Replacing: 71554102

Servicing: Volvo, Volvo Penta

B+ M6, Terminal W, Pulley w/o,
Fan w/o

B: 51.00 mm



113376 Alternator 14 V, 55 Amp

Replacing: 6020940MO30SM

Servicing: Bedford, Opel, Vauxhall

B+ M6, Terminal W, Grooves 1,
Pulley P, Fan EF

A: 76.60 B: 56.20 mm



110076# Alternator 28 V, 55 Amp
 Replacing: a14r33, a14n39, a14n133, 2960250
 Servicing: Pegaso, Scania
 B+ M6, Terminal W, Pulley w/o, Fan w/o
 B: 80.00 mm



110112 Alternator 28 V, 40 Amp
 Replacing: 2939210, 2937390
 Servicing: Volvo, Volvo Penta
 B+ M6, Terminal W, Pulley w/o, Fan w/o
 B: 51.00 mm



110113 Alternator 28 V, 27 Amp
 Replacing: 310426
 Servicing: Mercedes-Benz
 B+ M6, Pulley w/o, Fan EF
 B: 80.00 mm



110116 Alternator 28 V, 35 Amp
 Replacing: a13n33
 Servicing: DAF, Ford, MAN
 B+ M8, Terminal W, Pulley w/o, Fan w/o
 B: 80.00 mm



110117 ★ Alternator 28 V, 35 Amp
 Manufacturer: Valeo
 Replacing: 2960120
 Servicing: Iveco, Magirus-Deutz, Steyr, Various Agriculture Vehicles
 B+ M6, Pulley w/o, Fan EF
 B: 56.00 mm



110163 Alternator 28 V, 45 Amp
 Replacing: A13N5T, A13N56M, A13N4T, A13N283M, A13N283, A13N22T, A13N229T, A13N140T, A13N140, 2938680, 2541777
 Servicing: Renault V.I.
 B+ M6, Terminal W, Grooves 2, Pulley DP, Fan EF
 A: 48.75 B: 27.25 C: 67.50 mm

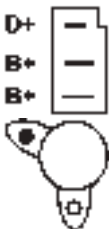

110178 ★ Alternator 14 V, 36 Amp
 Manufacturer: Lucas
 Replacing: 29409930, 2523234
 Servicing: Austin, Bedford, Case, Ford, Jensen, Land Rover, Lotus, Massey Ferguson, MG, Morris, New Holland, Plymouth, Talbot
 B+ 9.40, Pulley w/o, Fan EF
 B: 10.00 C: 87.00 mm

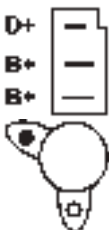

110759 Alternator 14 V, 35 Amp
 Replacing: 592798, 2541452, 2541239
 Servicing: Austin, Ford, Mercury
 B+ 9.40, Grooves 1, Pulley P, Fan EF
 A: 36.15 B: 10.50 C: 79.00 mm



110766 Alternator 28 V, 27 Amp
 Replacing: 2960150, 2523162
 Servicing: Atlas Copco, Case, Deutz-Fahr, Iveco, KHD, Liebherr, Magirus-Deutz, Mercedes-Benz, Steyr
 B+ M6, Terminal W, Pulley w/o, Fan EF
 B: 56.00 mm



110801 Alternator 28 V, 45 Amp
 Replacing: A13R182
 Servicing: Atlas Copco, Case, Caterpillar, Cummins, Fiat-Allis, International
 B+ 1/4" UNF, Terminal W, Pulley w/o, Fan EF
 B: 14.80 C: 100.00 mm



110805 Alternator 14 V, 45 Amp
 Replacing: AD150413, 2EA0550A1
 Servicing: Dodge, Mazda, Mitsubishi, Plymouth
 B+ M5, Grooves 1, Pulley P, Fan EF
 A: 45.30 B: 13.10 C: 54.20 mm



110889 Alternator 14 V, 75 Amp
 Replacing: A14N4, A14N163, A14N144, 2541324, 2541204
 Servicing: Renault, Renault V.I.
 B+ M6, Terminal W, Grooves 1, Pulley P, Fan EF
 A: 57.90 B: 26.90 C: 69.00 mm



110895 Alternator 28 V, 55 Amp
 Replacing: 523161, 2940780, 2940778
 Servicing: DAF, Kässbohrer, MAN, Mercedes-Benz, Ssangyong
 B+ M8, Terminal W, Pulley w/o, Fan EF
 B: 80.00 mm



110906 Alternator 28 V, 30 Amp
 Replacing: A13N166, 2104264
 Servicing: Mercedes-Benz
 B+ M8, Terminal W, Pulley w/o, Fan w/o
 B: 80.00 mm

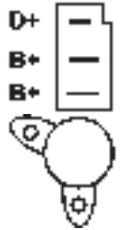

110923 Alternator 14 V, 55 Amp
 Replacing: A13V05, 2518046
 Servicing: Mercedes-Benz
 B+ Plug, Grooves 6, Pulley SP, Fan EF
 A: 92.00 B: 56.00 mm



111141 Alternator 14 V, 55 Amp
 Replacing: 523159, 523158, 2325158
 Servicing: MAN, Mercedes-Benz
 B+ M6, Terminal W, Pulley w/o, Fan w/o
 B: 80.00 mm

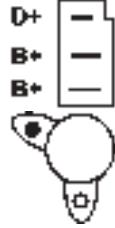

111289 Alternator 14 V, 70 Amp
 Replacing: 2950220, 2940981, 2929780, 2927070
 Servicing: Austin, Case, Dronningborg, Ford, Land Rover, Massey Ferguson, MG, Morris, Rover
 B+ 9.40, Terminal W, Grooves 1, Pulley P, Fan EF
 A: 35.00 B: 12.50 C: 80.00 mm

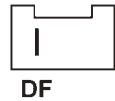

111331 Alternator 28 V, 60 Amp
 Manufacturer: Valeo
 Replacing: A14N44M, A14N3T, A14N3, A14N28T
 Servicing: Renault V.I.
 B+ M6, Terminal W, Grooves 2, Pulley DP, Fan EF
 A: 48.50 B: 27.30 C: 69.80 mm



111344 Alternator 28 V, 25 Amp
 Replacing: TA000A06101, M04419, APR225AA, AD225412, 2EA0501A
 Servicing: Mitsubishi
 B+ M5, Grooves 1, Pulley P, Fan EF
 A: 45.25 B: 12.55 C: 80.20 mm



111419 Alternator 28 V, 55 Amp
 Replacing: 2541423
 Servicing: Allis Chalmers, BENFRA, Fiat-Allis, Iveco, Laverda
 B+ M8, Terminal W, Grooves 2, Pulley DP, Fan EF
 A: 50.00 B: 17.45 C: 63.00 mm



111527[#] Alternator 28 V, 55 Amp
 Replacing: A14N135, 2541147
 Servicing: Scania
 B+ M6, Terminal W, Pulley w/o, Fan w/o
 B: 27.00 C: 66.70 mm



111528 Alternator 28 V, 55 Amp
 Replacing: 2180620, 2105473B
 Servicing: Volvo, Volvo BM, Volvo Penta
 B+ M8, Terminal W, Pulley w/o, Fan EF
 B: 51.50 mm



111631 Alternator 28 V, 55 Amp
 Replacing: A14N208M, A14N207M, A14N183M, A14N183, 2542514A, 2542514, 2542359, 2541624A, 2541624
 Servicing: Volvo
 B+ M8, Terminal W, Pulley w/o, Fan EF
 B: 14.10 C: 100.00 mm

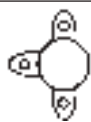

111658 Alternator 28 V, 55 Amp
 Replacing: A14N206M, A14N200M, A14N141M, A14N118M, 2541850, 2541828, 2541199D, 2541199B, 2541199, 2522104
 Servicing: Renault V.I., Volvo, Volvo Penta
 B+ M6, Terminal W, Pulley w/o, Fan w/o, Insulated return
 B: 50.75 mm

111720 Alternator 28 V, 90 Amp

Replacing: HD90S020ZD, HD90S019ZD, HD90S017ZD, HD90S016ZD, HD90S014ZD, HD90S014, HD90S013ZD, HD90S013

Servicing: Scania

B+ M8, Terminal W, Pulley w/o, Fan w/o

B: 22.70 C: 68.70 mm

111834 Alternator 28 V, 55 Amp

Replacing: A13N11

Servicing: Scania

B+ M8, Terminal W, Pulley w/o, Fan EF
Heavy duty type: HC-CARGO 112182 (80 A).

B: 80.00 mm

111890 Alternator 14 V, 90 Amp

Replacing: A13VI222

Servicing: Mercedes-Benz

B+ M8, Terminal W, Grooves 6, Pulley SP/FW, Fan IF

A: 92.00 B: 56.00 mm

111987 Alternator 28 V, 55 Amp

Replacing: A14N190, A14N189, A14N188, A14N187, A14N186, A14N185, A14N182, 2541648, 2541639, 2541638, 25416373

Servicing: Iveco

B+ M8, Terminal W, Pulley w/o, Fan EF

B: 17.00 C: 63.80 mm

112097 Alternator 28 V, 30 Amp

Replacing: 2939520

Servicing: Allis Chalmers, Astra, Fahr, Iveco, Laverda

B+ M6, Grooves 1, Pulley P, Fan w/o

A: 45.00 B: 17.00 C: 63.00 mm

112529 Alternator 14 V, 90 Amp

Replacing: A13VI99, A13VI197, A13VI175, A13VI134, 2541959, 2541919B, 2541919, 2541838A, 2541838, 2541775B

Servicing: Daewoo, John Deere, Mercedes-Benz, Ssangyong

B+ M8, Terminal W, Grooves 6, Pulley SP, Fan IF

A: 92.00 B: 56.10 mm

112657 Alternator 28 V, 60 Amp

Replacing: 390086, 21EA00040

Servicing: Various Industrial applications

B+ M6, Grooves 8, Pulley SP, Fan EF
One wire hookup(self-exciting) type.

A: 42.75 B: 14.85 C: 101.00 mm

112758# Alternator 28 V, 75 Amp

Replacing: A14N205, A14N160, A14N138, A14N104, 57158, 2541849, 2541329, 2541178

Servicing: Scania

B+ M8, Terminal W, Pulley w/o, Fan w/o

B: 27.00 C: 67.30 mm

113477 Alternator 28 V, 55 Amp

Replacing: A14N81M, A14N47M, A14N137M, A14N119M, A14N112M, A14N100M, A14N100, 2541168, 2181991C, 2181991

Servicing: DAF, Volvo, Volvo BM, Volvo Penta

B+ M6, Terminal W, Pulley w/o, Fan EF, Insulated return

B: 50.80 mm

113920 Alternator 28 V, 35 Amp

Replacing: A13N236M, A13N236, A13N23, 2541476

Servicing: MAN, Mercedes-Benz, Padane

B+ M8, Terminal W, Pulley w/o, Fan w/o

B: 80.40 mm



113650 Alternator 28 V, 80 Amp

Replacing: 160-68223

Servicing: Various Industrial applications, Volvo

B+ M8, Terminal W, Pulley w/o, Fan EF

B: 13.80 C: 90.90 mm



Starters

A: Mounting flange, B: Drive distance



Edition 2016/2017



110205 Starter 24 V, 6.5 kW

Replacing: 9000084024, 9000084019, 0001417041, 0001411012, 0001411008

Servicing: Volvo

 B+ M10, Total length 407.00, Drive type Steel, Gear type DD, Mount. holes 3 (0), Waterproof
 A: 89.00 B: 47.50 mm

110206 Starter 24 V, 5.4 kW

Replacing: 0001416079, 0001416078, 0001416023, 0001416002, 0001415027, 0001415001, 0001410088, 0001410002

Servicing: Claas, Fiat-Allis, Kässbohrer, MAN, Mercedes-Benz, Neoplan, Setra

B+ M12, B- M10, Total length 390.00, Drive type Steel, Gear type DD, Mount. holes 3 (0)

A: 92.00 B: 47.50 mm

110207 Starter 24 V, 5.4 kW

Replacing: 0001417035, 0001416070, 0001416007, 0001416005, 0001415013, 0001414019, 0001410046, 0001402057

Servicing: Volvo, Volvo BM

B+ M10, B- M10, Total length 387.00, Drive type Steel, Gear type DD, Mount. holes 3 (0)

A: 89.00 B: 47.00 mm

110208 Starter 24 V, 5.4 kW

Replacing: BNG4/24CRS162, 9000084018, 0001416076, 0001416021, 0001416009, 0001416008, 0001415016, 0001415004

Servicing: Fiat-Allis, Mercedes-Benz, Steyr, Volvo

B+ M10, B- M10, Total length 387.00, Drive type Steel, Gear type DD, Mount. holes 3 (0), Oil sealed, Waterproof

A: 89.00 B: 48.50 mm

110209 Starter 24 V, 5.4 kW

Replacing: 9000084008, 0001416043, 0001410067, 0001410060

Servicing: DAF

B+ M12, B- M10, Total length 387.00, Drive type Steel, Gear type DD, Mount. holes 3 (0)

A: 89.00 B: 47.00 mm



110210 Starter 24 V, 6.6 kW

Replacing: 0001417051, 0001417038, 0001417001, 0001411009, 0001410024

Servicing: Fiat-Allis, Kässbohrer, MAN, Mercedes-Benz, Mitsubishi, Neoplan, Ssangyong

B+ M12, B- M10, Total length 407.00, Drive type Steel, Gear type DD, Mount. holes 3 (0)

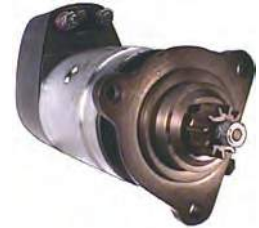
A: 92.00 B: 48.50 mm

110212 Starter 24 V, 6.6 kW

Replacing: 0001417046, 0001417045, 0001416048, 0001415015, 0001415014, 0001411005, 0001410115, 0001410098

Servicing: Iveco, Scania

B+ M10, B- M10, Total length 407.00, Drive type Steel, Gear type DD, Mount. holes 3 (0)

A: 92.00 B: 47.65 mm

110213 Starter 24 V, 6.6 kW

Replacing: 0001417005, 0001411025, 0001410065

Servicing: Fiat, Iveco

B+ M12, B- M10, Total length 407.00, Drive type Steel, Gear type DD, Mount. holes 3 (0)

A: 115.00 B: 20.80 mm

110214 Starter 24 V, 6.6 kW

Replacing: 0001501035, 0001501033, 0001501029, 0001501020, 0001417043, 0001415008, 0001410037

Servicing: Scania

B+ M10, B- M10, Total length 407.00, Drive type Steel, Gear type DD, Mount. holes 3 (0), Insulated return

A: 92.00 B: 37.00 mm

110368 Starter 12 V, 2.3 kW

Replacing: 9000143408, 9000143406, 0001362601, 0001362600, 0001362047, 0001362030, 0001362029, 0001362002
 Servicing: Audi, Mercedes-Benz, Volvo
 B+ M10, Total length 289.00, Drive type Steel, Gear type DD, Mount. holes 2 (2)
 A: 82.50 B: 21.00 mm

110409 Starter 12 V, 3.0 kW

Replacing: BNG4/12, 0001418002, 0001413003, 0001401045, 0001401044, 0001401037, 0001401036, 0001401005
 Servicing: Kaelble, Mack, Sennebogen
 B+ M10, Total length 384.00, Drive type Steel, Gear type DD, Mount. holes 3 (0)
 A: 89.00 B: 47.00 mm

110460 Starter 12 V, 2.8 kW

Replacing: 0001367022, 0001359126
 Servicing: Atlas Copco, Dronningborg, JCB, Massey Ferguson
 B+ M8, Total length 307.50, Drive type Steel, Gear type DD, Mount. holes 3 (0)
 A: 89.00 B: 29.50 mm

110465 Starter 12 V, 2.8 kW

Replacing: 0001359082
 Servicing: Ford
 B+ M8, Total length 309.00, Drive type Steel, Gear type DD, Mount. holes 3 (0)
 A: 92.00 B: 20.00 mm

110517 Starter 24 V, 3.2 kW

Replacing: 0001363111, 0001363101
 Servicing: BENFRA, Fiat, Fiat-Allis, Iveco
 B+ M10, Total length 295.00, Drive type Steel, Gear type DD, Mount. holes 3 (0)
 A: 110.00 B: 27.00 mm

110518 Starter 24 V, 4.0 kW

Replacing: 0001368020, 0001360063
 Servicing: BENFRA, Fiat, Fiat-Allis, Iveco
 B+ M10, Total length 342.00, Drive type Steel, Gear type DD, Mount. holes 3 (0)
 A: 110.00 B: 27.00 mm

110519 Starter 12 V, 3.0 kW

Replacing: 0001367073, 0001367030, 0001367026, 0001359071
 Servicing: Iveco, Volvo
 B+ M10, Total length 340.50, Drive type Steel, Gear type DD, Mount. holes 3 (0)
 A: 89.00 B: 48.00 mm

110521 Starter 24 V, 4.0 kW

Replacing: 0001368019, 0001360043, 0001360015
 Servicing: BENFRA, Fiat, Fiat-Allis, Iveco
 B+ M10, Total length 343.00, Drive type Steel, Gear type DD, Mount. holes 3 (0)
 A: 110.00 B: 27.00 mm

110523 Starter 24 V, 4.8 kW

Replacing: 0001368088, 0001368007, 0001368001, 0001360035, 0001360030, 0001360014, 0001360012, 0001360003
 Servicing: ABG, Ahlmann, Case, Compair, Iveco, KHD, Payloader
 B+ M10, Drive type Steel, Gear type DD, Mount. holes 3 (0)
 A: 89.00 B: 27.50 mm

110524 Starter 24 V, 4.0 kW

Replacing: B001816326, 9000143601, 9000083065, 0001368309, 0001368307, 0001368300, 0001368062, 0001368055
 Servicing: Mercedes-Benz
 B+ M10, Total length 341.00, Drive type Steel, Gear type DD, Mount. holes 3 (0)
 A: 89.00 B: 48.00 mm

110525 Starter 12 V, 3.0 kW

Replacing: 9007044002, 9000083054, 9000083028, 0001367303, 0001367301, 0001367300, 0001367059, 0001367034
 Servicing: Claas, Mercedes-Benz
 B+ M10, Total length 341.00, Drive type Steel, Gear type DD, Mount. holes 3 (0)
 A: 89.00 B: 48.00 mm

110527 Starter 24 V, 4.0 kW

Replacing: 0001368316, 0001368301, 0001368010, 0001360057, 0001360039, 0001360038, 0001360010
 Servicing: Scania, Steyr
 B+ M10, Total length 342.00, Drive type Steel, Gear type DD, Mount. holes 3 (0)
 A: 89.00 B: 46.50 mm



110531 Starter 24 V, 6.6 kW
 Replacing: 0001417036, 0001417017
 Servicing: Fiat-Allis, Gmeinder, KHD, Mercedes-Benz
 B+ M12, B- M10, Total length 405.00,
 Drive type Steel, Gear type DD
 A: 56.00 B: 37.00 mm



110532 Starter 24 V, 6.6 kW
 Replacing: 0001417074, 0001417073,
 0001417006, 0001411026, 0001411017
 Servicing: Iveco
 B+ M10, B- M10, Total length 405.00,
 Drive type Steel, Gear type DD,
 Mount. holes 3 (0), Waterproof
 A: 115.00 B: 21.00 mm



110533 Starter 24 V, 5.4 kW
 Replacing: 0001416003, 0001415011,
 0001410062
 Servicing: Steyr
 B+ M10, B- M10, Total length 387.00,
 Drive type Steel, Gear type DD,
 Mount. holes 3 (0)
 A: 89.00 B: 46.50 mm



110534 Starter 24 V, 5.4 kW
 Replacing: 0001416035, 0001416030,
 0001410109, 0001410099, 0001410063,
 0001410053
 Servicing: Ford, Iveco, Various Agriculture
 Vehicles
 B+ M10, Total length 390.00, Drive type Steel,
 Gear type DD, Mount. holes 3 (0)
 A: 89.00 B: 47.00 mm



110535 Starter 24 V, 5.4 kW
 Replacing: 0001416036, 0001410111
 Servicing: Iveco
 B+ M10, B- M10, Total length 384.00,
 Drive type Steel, Gear type DD,
 Mount. holes 3 (0)
 A: 89.00 B: 47.00 mm



110536 Starter 12 V, 2.7 kW
 Replacing: 26025155A, 0001367004,
 0001362313, 0001362311, 0001362305,
 0001362091, 0001362034, 0001362016
 Servicing: ABG, Atlas Copco, Bobcat, Bomag,
 Bosch, Case, Claas, Deutz-Fahr, Fendt, Irmer,
 Iveco, KHD, Kramer, Mercedes-Benz
 B+ M10, Total length 234.00, Drive type Steel,
 Gear type GR, Mount. holes 3 (0)
 A: 89.00 B: 28.00 mm



110582 Starter 24 V, 5.4 kW
 Replacing: 0001416052, 0001416011,
 0001415017, 0001410106
 Servicing: Iveco
 B+ M10, B- M10, Total length 384.00,
 Drive type Steel, Gear type DD,
 Mount. holes 3 (0)
 A: 92.00 B: 47.00 mm



110601 Starter 24 V, 5.4 kW
 Replacing: BNG4/24CRS165SR,
 BNG4/24CR165SR, 0001416013, 0001415010,
 0001414017, 0001410030, 0001410029
 Servicing: Mercedes-Benz, Steyr
 B+ M10, Total length 384.25, Drive type Steel,
 Gear type DD, Mount. holes 3 (0)
 A: 88.85 B: 47.50 mm



110640 Starter 12 V, 3.0 kW
 Replacing: 0001367014, 0001359091
 Servicing: Allis Chalmers, Fiat, Fiat-Allis, Long
 B+ M10, Total length 310.00, Drive type Steel,
 Gear type DD, Mount. holes 3 (0)
 A: 110.00 B: 26.00 mm



110775 Starter 12 V, 1.8 kW
 Replacing: 0001362038, 0001362028,
 0001362027, 0001362004, 0001362003
 Servicing: Claas, Mercedes-Benz
 B+ M10, Total length 288.00,
 Drive type Steel, Gear type DD,
 Clutch type Wet, Mount. holes 2 (0)
 A: 83.00 B: 20.00 mm



110844 Starter 12 V, 2.2 kW
 Replacing: 0001218122, 0001218011
 Servicing: Bedford, Ferrari, Goldoni,
 Lombardini, Opel, Valpadana, Vauxhall, VW
 B+ M8, Total length 278.45,
 Drive type Steel, Gear type GR,
 Mount. holes 2 (0)
 A: 82.50 B: 17.20 mm



110932 Starter 24 V, 5.4 kW
 Replacing: 0001416044, 0001410068,
 0001410057
 Servicing: DAF
 B+ M10, B- M10, Total length 384.50,
 Drive type Steel, Gear type DD,
 Mount. holes 3 (0), Insulated return
 A: 88.85 B: 47.00 mm



110980 Starter 24 V, 5.4 kW
 Replacing: 0001416065, 0001416061
 Servicing: Volvo
 B+ M10, B- M10, Total length 387.00,
 Drive type Steel, Gear type DD,
 Mount. holes 3 (0)
 A: 92.00 B: 47.00 mm



110981 Starter 24 V, 5.4 kW
 Replacing: 0001416067, 0001416062
 Servicing: DAF
 B+ M12, B- M10, Total length 387.00,
 Drive type Steel, Gear type DD,
 Mount. holes 3 (0)
 A: 110.00 B: 47.50 mm



110998 Starter 24 V, 5.2 kW
 Manufacturer: Prestolite
 Replacing: 0001368038
 Servicing: DAF, Ford
 B+ M8, Total length 166.00, Drive type Steel,
 Gear type DD, Mount. holes 3 (0)
 A: 92.00 B: 21.00 mm



110999 Starter 24 V
 Replacing: 0001420013, 0001420009,
 0001420005, 0001420004, 0001420003,
 0001420001
 Servicing: Case, Caterpillar, Fiat-Allis,
 Peterbilt Trucks, Various, Volvo
 B+ M12, B- M12, Total length 499.50,
 Drive type Steel, Gear type DD,
 Mount. holes 3 (0), Insulated return, Oil sealed
 Replacing: 42MT.
 A: 92.00 B: 46.50 mm



111003 Starter 24 V, 5.4 kW
 Replacing: 0001416004, 0001415007,
 0001410094, 0001410052
 Servicing: Hanomag, Mercedes-Benz
 B+ M10, Total length 387.50,
 Drive type Steel, Gear type DD,
 Mount. holes 3 (0), Waterproof
 A: 89.00 B: 47.50 mm



111046 Starter 24 V, 6.6 kW
 Replacing: 0001417002
 Servicing: MAN, Volvo
 B+ M10, Total length 404.00, Drive type Steel,
 Gear type DD, Mount. holes 3 (0)
 A: 88.85 B: 48.00 mm



111047 Starter 12 V, 3.1 kW
 Replacing: 0001367049, 0001359119
 Servicing: Volvo, Volvo Penta
 B+ M8, Total length 302.75,
 Drive type Steel, Gear type GR,
 Mount. holes 3 (0), Insulated return
 A: 88.85 B: 47.70 mm



111217 Starter 12 V, 3.0 kW
 Replacing: BNG4/12CR222, 0001418004,
 0001418003, 0001413010, 0001413007,
 0001401068, 0001401052, 0001401028
 Servicing: Volvo, Volvo BM
 B+ M10, B- M10, Total length 386.50,
 Drive type Steel, Gear type DD,
 Mount. holes 3 (0)
 A: 89.00 B: 48.00 mm



111231 Starter 24 V, 6.6 kW
 Replacing: 0001417061, 0001417053
 Servicing: Renault V.I.
 B+ M10, B- M10, Total length 405.00,
 Drive type Steel, Gear type DD,
 Mount. holes 3 (0), Insulated return
 A: 89.00 B: 40.25 mm



111249 Starter 24 V, 5.4 kW
 Replacing: BNG4/24CRS165BR,
 BNG4/24CR165BR, 0001416027, 0001416017,
 0001414018, 0001402058, 0001402056
 Servicing: Various Industrial applications
 B+ M10, Total length 381.80,
 Drive type Bronze, Gear type DD,
 Mount. holes 3 (0), Waterproof
 A: 89.00 B: 48.25 mm



111399 Starter 24 V, 4.0 kW
 Replacing: 0001368083
 Servicing: DAF
 B+ M10, B- M8, Total length 352.50,
 Drive type Steel, Gear type DD,
 Clutch type Dry, Mount. holes 3 (0)
 A: 89.00 B: 38.00 mm



111573 Starter 12 V, 2.8 kW
 Replacing: 0001359116
 Servicing: Avia, JCB, TCM, Various
 Agriculture Vehicles
 B+ M8, Total length 311.00, Drive type Steel,
 Gear type DD/GR, Mount. holes 3 (0)
 A: 101.00 B: 25.50 mm

111637 Starter 24 V, 4.0 kW

Replacing: 0001368034, 0001360058, 0001360026, 0001231012

Servicing: DAF

B+ M10, Total length 341.00, Drive type Steel, Gear type DD/GR, Mount. holes 3 (0)

A: 88.80 B: 48.00 mm

111638 Starter 24 V, 4.0 kW

Replacing: 0001231014

Servicing: Volvo

B+ M10, Total length 308.00, Drive type Steel, Gear type DD, Mount. holes 3 (0)

A: 89.00 B: 47.70 mm

111640 Starter 24 V, 4.0 kW

Replacing: 0001368081, 0001368016

Servicing: MAN

B+ M10, Total length 338.50, Drive type Steel, Gear type DD, Mount. holes 3 (0)

A: 88.50 B: 28.00 mm

111771 Starter 24 V, 6.2 kW

Replacing: 0001372001

Servicing: Mercedes-Benz

B+ M12, Total length 405.00, Drive type Steel, Gear type DD, Mount. holes 3 (0)

A: 92.00 B: 47.00 mm

111793 Starter 12 V, 3.0 kW

Replacing: 0001367076, 0001367048, 0001367017, 0001359088, 0001359020

Servicing: Caterpillar, Mercedes-Benz, Volvo

B+ M10, Total length 342.00, Drive type Steel, Gear type DD, Clutch type Dry, Mount. holes 3 (0)

A: 88.80 B: 28.50 mm

111805 Starter 12 V, 2.5 kW

Replacing: 9000331203, 9000331201

Servicing: Ford, Nissan

B+ M8, Total length 228.00, Drive type Steel, Gear type GR, Mount. holes 2 (0)

A: 95.00 B: 11.50 mm

111851 Starter 12 V, 2.0 kW

Replacing: 0001218738, 0001218138, 0001218124, 0001110112, 0001110091, 0001110075, 0001110016, 0001109290

Servicing: Mercedes-Benz

B+ M8, Total length 240.00, Drive type Steel, Gear type GR, Mount. holes 2 (2)

A: 82.50 B: 25.50 mm

111910 Starter 24 V, 6.7 kW

Replacing: 0001371006

Servicing: Scania

B+ M12, 30h M12, Total length 429.00, Drive type Steel, Gear type DD, Clutch type Dry, Mount. holes 3 (0), Not Insulated return

A: 92.00 B: 47.00 mm

112039 Starter 12 V, 2.7 kW

Replacing: 0001366004, 0001358038, 0001354091, 0001354012

Servicing: Fendt, Jenbacher Werke, KHD, Lombardini

B+ M10, Total length 295.00, Drive type Steel, Gear type DD, Mount. holes 2 (0)

A: 82.50 B: 21.00 mm

112055 Starter 24 V, 5.2 kW

Manufacturer: Bosch

Replacing: 0001368313, 0001364400, 0001231041, 0001231013

Servicing: DAF

B+ M10, Total length 340.00, Drive type Steel, Gear type DD, Mount. holes 3 (0)

A: 110.00 B: 48.00 mm

112116 Starter 24 V, 6.6 kW

Replacing: 0001417075, 0001417065

Servicing: Volvo

B+ M12, B- M12, Total length 407.00, Drive type Steel, Gear type DD, Mount. holes 3 (0), Insulated return

A: 92.00 B: 47.00 mm

112119 Starter 24 V, 6.6 kW

Replacing: 0001417042

Servicing: Scania

B+ M10, B- M10, Total length 406.00, Drive type Steel, Gear type DD, Mount. holes 3 (0)

A: 92.00 B: 37.00 mm



112120 Starter 24 V, 6.6 kW
 Replacing: 0001417037, 0001411022
 Servicing: MAN, Mercedes-Benz
 B+ M12, B- M10, Total length 405.00,
 Drive type Steel, Gear type DD,
 Mount. holes 3 (0), Insulated return
 A: 92.00 B: 47.50 mm



112174 Starter 24 V, 3.2 kW
 Replacing: 0001363123
 Servicing: Mercedes-Benz
 B+ M10, Total length 289.00,
 Drive type Steel, Gear type DD,
 Mount. holes 2 (2)
 A: 82.50 B: 21.00 mm



112224 Starter 24 V, 6.7 kW
 Replacing: 0001371004
 Servicing: Scania
 B+ M12, Total length 428.00,
 Drive type Steel, Gear type DD,
 Clutch type Dry, Mount. holes 3 (0)
 A: 92.00 B: 48.00 mm



112437# Starter 24 V, 6.7 kW
 Replacing: 0001371008
 Servicing: Scania
 B+ M12, Total length 430.00,
 Drive type Steel, Gear type DD,
 Clutch type Wet, Mount. holes 3 (0)
 A: 92.00 B: 36.50 mm



112494 Starter 24 V, 4.0 kW
 Replacing: 0001263008, 0001231028,
 0001231005
 Servicing: Volvo
 B+ M10, Total length 316.00,
 Drive type Steel, Gear type GR,
 Clutch type Dry, Mount. holes 3 (0)
 A: 89.00 B: 29.00 mm



112498 Starter 24 V, 4.0 kW
 Replacing: 0001263022, 0001263021,
 0001231016
 Servicing: Iveco
 B+ M10, Total length 315.00,
 Drive type Steel, Gear type DD,
 Clutch type Dry, Mount. holes 3 (0)
 A: 88.75 B: 49.00 mm



112534 Starter 12 V, 2.0 kW
 Replacing: 0001109035
 Servicing: JCB, KHD, Perkins
 B+ M8, Total length 239.00, Drive type Steel,
 Gear type GR, Mount. holes 2 (0)
 A: 74.00 B: 18.00 mm



112581 Starter 24 V, 6.2 kW
 Replacing: B001860023, B001860021,
 0001372008, 0001372007, 0001372003,
 0001372002, 0001371015, 0001371010
 Servicing: DAF
 B+ M12, Total length 380.00, Drive type Steel,
 Gear type DD, Mount. holes 3 (0)
 A: 110.00 B: 48.00 mm



112651 Starter 24 V, 4.8 kW
 Replacing: 0001364300, 0001364101
 Servicing: Bosch, KHD
 B+ M10, Total length 351.50, Drive type Steel,
 Gear type DD, Mount. holes 3 (0)
 A: 89.00 B: 48.00 mm



112670 Starter 24 V, 4.0 kW
 Replacing: 0001368051, 0001368040,
 0001368026
 Servicing: DAF, Hanomag, Mercedes-Benz,
 Perkins
 B+ M10, Total length 341.00,
 Drive type Steel, Gear type DD,
 Mount. holes 3 (0)
 A: 88.80 B: 28.50 mm



113183 Starter 24 V, 4.0 kW
 Manufacturer: Bosch
 Replacing: 0001231010
 Servicing: Iveco
 B+ M10, Total length 315.00,
 Drive type Steel, Gear type GR,
 Clutch type Dry, Mount. holes 3 (0)
 A: 110.00 B: 28.00 mm



113277 Starter 24 V, 4.0 kW
 Replacing: 0001231011
 Servicing: Iveco
 B+ M10, Total length 315.00,
 Drive type Steel, Gear type GR,
 Mount. holes 3 (0)
 A: 109.80 B: 27.50 mm

113380 Starter 12 V, 2.8 kW

Replacing: 0001367056

Servicing: Ford

 B+ M8, B- M8, Total length 307.00,
 Drive type Steel, Gear type DD,
 Mount. holes 3 (0)

A: 91.80 B: 20.00 mm

113389 Starter 12 V, 2.2 kW

 Replacing: 0001218710, 0001218110,
 0001218016

Servicing: Mercedes-Benz

 B+ M8, Total length 272.50,
 Drive type Steel, Gear type GR,
 Mount. holes 2 (2)

A: 82.40 B: 25.00 mm

113464 Starter 24 V, 4.0 kW

Replacing: 0001364301, 0001364100

Servicing: ABG, Irmer, Iveco, KHD

 B+ M10, Total length 346.50,
 Drive type Steel, Gear type DD,
 Clutch type Dry, Mount. holes 3 (0)

A: 89.00 B: 28.80 mm

113465 Starter 12 V, 3.0 kW

 Replacing: 0001367302, 0001367070,
 0001359095, 0001359008, 0001358034

Servicing: Renault V.I.

 B+ M10, Total length 338.00,
 Drive type Steel, Gear type DD,
 Clutch type Dry, Mount. holes 3 (0)

A: 88.75 B: 21.50 mm

113466 Starter 24 V, 4.0 kW

 Replacing: 0001368306, 0001368304,
 0001368070, 0001368052, 0001360050,
 0001360013, 0001231009

Servicing: Renault V.I.

 B+ M10, Total length 316.00,
 Drive type Steel, Gear type DD/GR,
 Clutch type Dry, Mount. holes 3 (0)

A: 88.90 B: 22.00 mm

113467 Starter 12 V, 3.7 kW

Replacing: 0001365004

Servicing: Atlas Copco, Deutz-Fahr, Iveco

 B+ M10, Total length 346.00,
 Drive type Steel, Gear type DD,
 Clutch type Dry, Mount. holes 3 (0)

A: 88.80 B: 28.00 mm

113468 Starter 24 V, 4.0 kW

 Replacing: 0001368317, 0001368310,
 0001368305, 0001368056

Servicing: MAN

 B+ M10, Total length 340.00,
 Drive type Steel, Gear type DD,
 Clutch type Dry, Mount. holes 3 (0)
 Bosch GR HC-CARGO 112446.

A: 89.00 B: 27.00 mm

113608 Starter 24 V, 6.2 kW

Replacing: 0001372005

Servicing: Evobus, Kässbohrer, Mercedes-Benz

 B+ M12, 15a M6, Total length 380.50,
 Drive type Steel, Gear type DD/GR,
 Clutch type Wet, Mount. holes 3 (0)

A: 92.00 B: 46.25 mm

113609 Starter 24 V, 6.2 kW

Replacing: 0001372006

Servicing: Mercedes-Benz

 B+ M12, 15a M6S, Total length 391.00,
 Drive type Steel, Gear type DD/GR,
 Clutch type Dry, Mount. holes 3 (0)

A: 92.00 B: 48.00 mm

113759 Starter 24 V, 4.0 kW

Replacing: 0001231029, 0001231008

Servicing: MAN

 B+ M10, Total length 315.00,
 Drive type Steel, Gear type GR,
 Clutch type Dry, Mount. holes 3 (0)

A: 89.00 B: 29.00 mm

113760 Starter 24 V, 4.0 kW

 Replacing: 0001263002, 0001263001,
 0001231045, 0001231017

Servicing: DAF

 B+ M10, Total length 315.00,
 Drive type Steel, Gear type DD,
 Clutch type Dry, Mount. holes 3 (0)

A: 89.00 B: 27.00 mm

113830 Starter 24 V, 5.5 kW

Replacing: 0001261049

Servicing: Volvo

 B+ M10, Total length 350.00,
 Drive type Steel, Gear type GR,
 Clutch type Dry, Mount. holes 3 (0)
 Over Crank Protection.

A: 92.00 B: 47.50 mm



113855 Starter 24 V, 5.4 kW
 Replacing: 0001416010
 Servicing: MAN, Mercedes-Benz
 B+ M12, B- M10, Total length 381.00,
 Drive type Steel, Gear type DD,
 Mount. holes 3 (0), Insulated return
 A: 92.00 B: 51.00 mm



113859 Starter 24 V, 6.0 kW
 Replacing: 0001330008
 Servicing: Scania
 B+ M10, B- M6, Total length 385.00,
 Drive type Steel, Gear type GR,
 Clutch type Dry, Mount. holes 3 (0)
 A: 92.00 B: 48.00 mm



113891 Starter 24 V, 5.5 kW
 Replacing: 0001261028, 0001261027,
 0001261026, 0001261025, 0001261002,
 0001261001, 0001241001
 Servicing: Scania
 B+ M10, Total length 317.00,
 Drive type Steel, Gear type GR,
 Clutch type Dry, Mount. holes 3 (0)
 Alternative no.: 115509
 A: 92.00 B: 48.00 mm



113934 Starter 24 V, 5.5 kW
 Replacing: 0001241119, 0001241019,
 0001241014, 0001241007, 0001241003
 Servicing: Bova, DAF, Solaris
 B+ M10, Total length 321.00, Drive type Steel,
 Gear type GR, Mount. holes 3 (0)
 A: 110.00 B: 48.00 mm



113979 Starter 24 V, 4.0 kW
 Replacing: 0001231003
 Servicing: Mercedes-Benz
 B+ M10, Total length 310.00,
 Gear type GR, Mount. holes 3 (0)
 A: 89.00 B: 48.50 mm



114001 Starter 24 V, 4.0 kW
 Replacing: 0001231034, 0001231023
 Servicing: MAN
 B+ M8, Total length 317.00,
 Drive type Steel, Gear type GR,
 Mount. holes 3 (0)
 w/ safety switch.
 A: 89.00 B: 29.00 mm



114031 Starter 24 V, 5.5 kW
 Replacing: 0001241021, 0001241009,
 0001241005
 Servicing: MAN
 B+ M10, Total length 318.50,
 Gear type GR, Mount. holes 3 (0)
 A: 92.00 B: 48.00 mm



114033 Starter 24 V, 4.0 kW
 Replacing: 0001231004
 Servicing: Volvo
 B+ M10, B- M10, Total length 266.00,
 Gear type GR, Mount. holes 3 (0)
 A: 92.00 B: 47.00 mm



114069 Starter 24 V, 4.0 kW
 Replacing: 0001263054, 0001263053, 0001263004,
 0001263003, 0001231040, 0001231036
 Servicing: DAF
 B+ M10, Total length 318.00, Drive type Steel,
 Gear type DD/GR, Mount. holes 3 (0)
 w/ safety switch.
 A: 110.00 B: 48.00 mm



114073 Starter 24 V, 5.5 kW
 Replacing: 0001261069, 0001261045,
 0001261044, 0001261013, 0001261012,
 0001261008, 0001261007, 0001241020
 Servicing: Bova, DAF, Solaris
 B+ M10, Total length 319.00, Drive type Steel,
 Gear type DD/GR, Mount. holes 3 (0)
 w/ safety switch.
 Alternative no.: 115511
 A: 110.00 B: 47.00 mm



114193 Starter 24 V, 5.5 kW
 Replacing: 0001261041
 Servicing: Renault V.I., Volvo
 B+ M10, Total length 350.00,
 Gear type GR, Mount. holes 3 (0)
 A: 89.00 B: 48.00 mm



114310 Starter 24 V, 7.0 kW
 Replacing: 0001330057
 Servicing: Volvo
 B+ M10, Total length 352.00, Drive type Steel,
 Gear type GR, Mount. holes 3 (0)
 A: 92.00 B: 46.00 mm

114376 Starter 24 V, 4.0 kW

Replacing: 0001231035

Servicing: MAN

 B+ M10, Total length 311.50,
 Gear type GR, Mount. holes 3 (0)
w/ safety switch.

 Alternative no.: 115513 **5★**

A: 89.00 B: 29.00 mm

114395 Starter 12 V, 3.0 kW

 Replacing: 0001262006, 0001230027,
 0001230001

Servicing: Mercedes-Benz

 B+ M10, Total length 316.50,
 Drive type Steel, Gear type GR,
 Clutch type Dry, Mount. holes 3 (0)

A: 89.00 B: 49.00 mm

114437 Starter 24 V, 5.4 kW

Replacing: 0001416031

 Servicing: Atlas Copco, Bosch, Ford, KHD,
 Poclairn

 B+ M10, B- M10, Total length 324.00,
 Drive type Steel, Gear type DD,
 Mount. holes 3 (0), Insulated return

A: 89.00 B: 47.50 mm

114446 Starter 24 V, 5.4 kW

Replacing: 0001416046

Servicing: Iveco

 B+ M10, Total length 387.00, Drive type Steel,
 Gear type DD, Mount. holes 3 (0)

A: 92.00 B: 47.50 mm

114523 Starter 24 V, 4.0 kW

 Replacing: B001260015, 0001263049,
 0001263016, 0001263015, 0001231133,
 0001231033, 0001231032, 0001231002

Servicing: Mercedes-Benz

 B+ M10, Total length 313.00,
 Drive type Steel, Gear type GR,
 Mount. holes 3 (0)

 Alternative no.: 115514 **5★**

A: 89.00 B: 48.50 mm

114676 Starter 12 V, 2.2 kW

Replacing: 0001362705

Servicing: KHD

 B+ M10, Total length 293.00,
 Drive type Steel, Gear type DD,
 Clutch type Dry, Mount. holes 3 (0)

A: 82.50 B: 23.00 mm

114702 Starter 24 V, 4.0 kW

Replacing: 0001261006, 0001241016

Servicing: Kamaz

 B+ M10, Total length 321.00,
 Gear type DD, Mount. holes 3 (0)

A: 92.00 B: 47.00 mm

115464* Starter 24 V, 6.0 kW

Replacing: 0001330012

Mount. holes 3 (0)

115505 **5★** Starter 12 V, 2.3 kW

Manufacturer: Bosch

Replacing: 0001109371, 0001109306

 Servicing: Iveco, Mitsubishi, Multicar, Renault
 V.I.

 B+ M8, Total length 246.00,
 Gear type GR, Mount. holes 3 (3), Not
 Insulated return

Alternative no.: 112441

A: 82.00 B: 27.00 mm

115509 **5★** Starter 24 V, 5.5 kW

Manufacturer: Bosch

 Replacing: 0001261028, 0001261027,
 0001261026

Servicing: Scania

 B+ M10, Total length 325.00,
 Gear type GR, Mount. holes 3 (0), Not
 Insulated return

Alternative no.: 113891

A: 92.00 B: 48.00 mm

115511 **5★** Starter 24 V, 5.5 kW

Manufacturer: Bosch

 Replacing: 0001261069, 0001261045,
 0001261044, 0001261013, 0001261012

Servicing: Bova, DAF, Minelli, Solaris

 B+ M10, Total length 324.00,
 Gear type DD/GR, Mount. holes 3 (0),
 Not Insulated return
w/ safety switch.

Alternative no.: 114073

A: 110.00 B: 47.00 mm

NEW PRODUCT
www.hc-cargo.com



115513 Starter 24 V, 4.0 kW

Manufacturer: Bosch

Replacing: 0001231035

Servicing: MAN

B+ M10, Total length 315.00,
Gear type GR, Mount. holes 3 (0), Not
Insulated return
w/ safety switch.

Alternative no.: 114376OE

A: 89.00 B: 29.00 mm



115514 Starter 24 V, 4.0 kW

Manufacturer: Bosch

Replacing: 0001231133, 0001231033

Servicing: Mercedes-Benz

B+ M10, Total length 313.00,
Gear type GR, Mount. holes 3 (0), Not
Insulated return

Alternative no.: 114523

A: 89.00 B: 48.50 mm



115515 Starter 12 V, 2.0 kW

Manufacturer: Bosch

Replacing: 0001109046

Servicing: GAZ

B+ M8, Total length 246.00,
Gear type GR, Mount. holes 3 (0), Not
Insulated return

A: 88.88 B: 23.00 mm



NEW PRODUCT
www.hc-cargo.com

115623* 24 V, 4.0 kW

Replacing: 0001368074, 0001368063,
0001368017, 0001360061

Gear type DD, Mount. holes 3 (0)

110205 Starter 24 V, 6.5 kW

Replacing: 860500, 858881, 857466

Servicing: Volvo

 B+ M10, Total length 407.00,
 Drive type Steel, Gear type DD,
 Mount. holes 3 (0), Waterproof

A: 89.00 B: 47.50 mm

110206 Starter 24 V, 5.4 kW

Replacing: 860508, 857470

 Servicing: Claas, Fiat-Allis, Kässbohrer, MAN,
 Mercedes-Benz, Neoplan, Setra

 B+ M12, B- M10, Total length 390.00,
 Drive type Steel, Gear type DD,
 Mount. holes 3 (0)

A: 92.00 B: 47.50 mm

110207 Starter 24 V, 5.4 kW

Servicing: Volvo, Volvo BM

 B+ M10, B- M10, Total length 387.00,
 Drive type Steel, Gear type DD,
 Mount. holes 3 (0)

A: 89.00 B: 47.00 mm

110208 Starter 24 V, 5.4 kW

Replacing: 860504, 860121

 Servicing: Fiat-Allis, Mercedes-Benz, Steyr,
 Volvo

 B+ M10, B- M10, Total length 387.00,
 Drive type Steel, Gear type DD,
 Mount. holes 3 (0), Oil sealed, Waterproof

A: 89.00 B: 48.50 mm

110210 Starter 24 V, 6.6 kW

Replacing: 860506, 860132, 857468

 Servicing: Fiat-Allis, Kässbohrer, MAN,
 Mercedes-Benz, Mitsubishi, Neoplan,
 Ssangyong

 B+ M12, B- M10, Total length 407.00,
 Drive type Steel, Gear type DD,
 Mount. holes 3 (0)

A: 92.00 B: 48.50 mm

110214 Starter 24 V, 6.6 kW

Replacing: 860548

Servicing: Scania

 B+ M10, B- M10, Total length 407.00,
 Drive type Steel, Gear type DD,
 Mount. holes 3 (0), Insulated return

A: 92.00 B: 37.00 mm

110517 Starter 24 V, 3.2 kW

Replacing: 860104

Servicing: BENFRA, Fiat-Allis, Iveco

 B+ M10, Total length 295.00,
 Drive type Steel, Gear type DD,
 Mount. holes 3 (0)

A: 110.00 B: 27.00 mm

110518 Starter 24 V, 4.0 kW

Replacing: LNS4524/20, 859542

Servicing: BENFRA, Fiat, Fiat-Allis, Iveco

 B+ M10, Total length 342.00,
 Drive type Steel, Gear type DD,
 Mount. holes 3 (0)

A: 110.00 B: 27.00 mm

110523 Starter 24 V, 4.8 kW

Replacing: LNS4524/17, 859539

 Servicing: ABG, Ahlmann, Case, Compair,
 Iveco, KHD, Payloader

 B+ M10, Drive type Steel, Gear type DD,
 Mount. holes 3 (0)

A: 89.00 B: 27.50 mm

110524 Starter 24 V, 4.0 kW

Replacing: LNS4524/15, 859537, 858780

Servicing: Mercedes-Benz

 B+ M10, Total length 341.00,
 Drive type Steel, Gear type DD,
 Mount. holes 3 (0)

A: 89.00 B: 48.00 mm

110525 Starter 12 V, 3.0 kW

Replacing: 860130, 860109

Servicing: Claas, Mercedes-Benz

 B+ M10, Total length 341.00,
 Drive type Steel, Gear type DD,
 Mount. holes 3 (0)

A: 89.00 B: 48.00 mm

110527 Starter 24 V, 4.0 kW

Replacing: LNS4524/13, 859535, 857472

Servicing: Scania, Steyr

 B+ M10, Total length 342.00,
 Drive type Steel, Gear type DD,
 Mount. holes 3 (0)

A: 89.00 B: 46.50 mm



110535 Starter 24 V, 5.4 kW
 Replacing: 860655, 860115
 Servicing: Iveco
 B+ M10, B- M10, Total length 384.00,
 Drive type Steel, Gear type DD,
 Mount. holes 3 (0)
 A: 89.00 B: 47.00 mm



110582 Starter 24 V, 5.4 kW
 Replacing: 860516, 860125
 Servicing: Iveco
 B+ M10, B- M10, Total length 384.00,
 Drive type Steel, Gear type DD,
 Mount. holes 3 (0)
 A: 92.00 B: 47.00 mm



110721# Starter 24 V, 7.1 kW
 Replacing: MS1A/12, MS1/400A, MS1/100,
 MS1-400C, MS1-400A, MS1-300C, MS1-300A,
 MS1-129, MS1-100, 859471
 Servicing: ERF, Foden, LDV International
 B+ M12, 15a M6, Total length 483.00,
 Drive type Steel, Gear type DD,
 Mount. holes 3 (0), Insulated return
 A: 92.00 B: 46.55 mm



110980 Starter 24 V, 5.4 kW
 Replacing: 860512, 860110, 858878
 Servicing: Volvo
 B+ M10, B- M10, Total length 387.00,
 Drive type Steel, Gear type DD,
 Mount. holes 3 (0)
 A: 92.00 B: 47.00 mm



110981 Starter 24 V, 5.4 kW
 Replacing: 860509, 859021
 Servicing: DAF
 B+ M12, B- M10, Total length 387.00,
 Drive type Steel, Gear type DD,
 Mount. holes 3 (0)
 A: 110.00 B: 47.50 mm



110998 Starter 24 V, 5.2 kW
 Manufacturer: Prestolite
 Replacing: 870651
 Servicing: DAF, Ford
 B+ M8, Total length 166.00,
 Drive type Steel, Gear type DD,
 Mount. holes 3 (0)
 A: 92.00 B: 21.00 mm



111231 Starter 24 V, 6.6 kW
 Replacing: 860123
 Servicing: Renault V.I.
 B+ M10, B- M10, Total length 405.00,
 Drive type Steel, Gear type DD,
 Mount. holes 3 (0), Insulated return
 A: 89.00 B: 40.25 mm



111399 Starter 24 V, 4.0 kW
 Replacing: LNS4524/9, 859506, 859022
 Servicing: DAF
 B+ M10, B- M8, Total length 352.50,
 Drive type Steel, Gear type DD,
 Clutch type Dry, Mount. holes 3 (0)
 A: 89.00 B: 38.00 mm



111574 Starter 12 V, 2.8 kW
 Replacing: 858762
 Servicing: ERF, LDV International, Various
 Agriculture Vehicles
 B+ M8, Total length 340.00,
 Drive type Steel, Gear type DD,
 Mount. holes 3 (0)
 A: 88.75 B: 47.15 mm



111638 Starter 24 V, 4.0 kW
 Replacing: LNS4524/12, 859534
 Servicing: Volvo
 B+ M10, Total length 308.00,
 Drive type Steel, Gear type DD,
 Mount. holes 3 (0)
 A: 89.00 B: 47.70 mm



111640 Starter 24 V, 4.0 kW
 Replacing: LNS4524/16, 859538, 858318
 Servicing: MAN
 B+ M10, Total length 338.50,
 Drive type Steel, Gear type DD,
 Mount. holes 3 (0)
 A: 88.50 B: 28.00 mm



111910 Starter 24 V, 6.7 kW
 Replacing: 860305
 Servicing: Scania
 B+ M12, 30h M12, Total length 429.00,
 Drive type Steel, Gear type DD,
 Clutch type Dry, Mount. holes 3 (0), Not
 Insulated return
 A: 92.00 B: 47.00 mm

111982 Starter 24 V, 4.0 kW

Replacing: 860321

Servicing: Mercedes-Benz

 B+ M10, Total length 342.00,
 Drive type Steel, Gear type GR,
 Mount. holes 3 (0)

A: 88.75 B: 45.00 mm

112055 Starter 24 V, 5.2 kW

Manufacturer: Bosch

Replacing: 860304

Servicing: DAF

 B+ M10, Total length 340.00,
 Drive type Steel, Gear type DD,
 Mount. holes 3 (0)

A: 110.00 B: 48.00 mm

112116 Starter 24 V, 6.6 kW

Replacing: 860511

Servicing: Volvo

 B+ M12, B- M12, Total length 407.00,
 Drive type Steel, Gear type DD,
 Mount. holes 3 (0), Insulated return

A: 92.00 B: 47.00 mm

112119 Starter 24 V, 6.6 kW

Replacing: 860505, 858879

Servicing: Scania

 B+ M10, B- M10, Total length 406.00,
 Drive type Steel, Gear type DD,
 Mount. holes 3 (0)

A: 92.00 B: 37.00 mm

112656[#] Starter 24 V, 4.5 kW

 Replacing: MS4/400, MS4-400, LNS4524/5,
 LNS4524/11, 869399Z, 860603, 859532, 859399

Servicing: DAF, ERF, Foden, Seddon

 B+ M10, Total length 375.00,
 Drive type Steel, Gear type DD,
 Mount. holes 3 (0)

A: 89.00 B: 48.00 mm

113333[#] Starter 24 V, 7.0 kW

 Replacing: MS1/410A, MS1-409A, MS1-404P,
 MS1-130, MS1-119, MS1-110, MS1-109, MS1-
 104, MS1, 859344, 858900

Servicing: Seddon

 B+ M12, B- M12, Total length 483.00,
 Drive type Steel, Gear type DD,
 Mount. holes 3 (0), Insulated return

A: 92.00 B: 47.00 mm

113380 Starter 12 V, 2.8 kW

Replacing: 860106

Servicing: Ford

 B+ M8, B- M8, Total length 307.00,
 Drive type Steel, Gear type DD,
 Mount. holes 3 (0)

A: 91.80 B: 20.00 mm

113389 Starter 12 V, 2.2 kW

Replacing: 860100

Servicing: Mercedes-Benz

 B+ M8, Total length 272.50, Drive type Steel,
 Gear type GR, Mount. holes 2 (2)

A: 82.40 B: 25.00 mm

113466 Starter 24 V, 4.0 kW

Replacing: 860103

Servicing: Renault V.I.

 B+ M10, Total length 316.00,
 Drive type Steel, Gear type DD/GR,
 Clutch type Dry, Mount. holes 3 (0)

A: 88.90 B: 22.00 mm

114193 Starter 24 V, 5.5 kW

Replacing: 860822

Servicing: Renault V.I., Volvo

 B+ M10, Total length 350.00,
 Gear type GR, Mount. holes 3 (0)

A: 89.00 B: 48.00 mm

110205 Starter 24 V, 6.5 kW

Replacing: S130L24-21, 2311210

Servicing: Volvo

 B+ M10, Total length 407.00,
 Drive type Steel, Gear type DD,
 Mount. holes 3 (0), Waterproof

A: 89.00 B: 47.50 mm

110206 Starter 24 V, 5.4 kW

Replacing: S115HD24-1, 2998011, 1403000

 Servicing: Claas, Fiat-Allis, Kässbohrer, MAN,
 Mercedes-Benz, Neoplan, Setra

 B+ M12, B- M10, Total length 390.00,
 Drive type Steel, Gear type DD,
 Mount. holes 3 (0)

A: 92.00 B: 47.50 mm

110207 Starter 24 V, 5.4 kW

 Replacing: S115A24-21, 2998008, 1327A601,
 1327A600

Servicing: Volvo, Volvo BM

 B+ M10, B- M10, Total length 387.00,
 Drive type Steel, Gear type DD,
 Mount. holes 3 (0)

A: 89.00 B: 47.00 mm

110209 Starter 24 V, 5.4 kW

Replacing: 2998009

Servicing: DAF

 B+ M12, B- M10, Total length 387.00,
 Drive type Steel, Gear type DD,
 Mount. holes 3 (0)

A: 89.00 B: 47.00 mm

110210 Starter 24 V, 6.6 kW

Replacing: 2998010

 Servicing: Fiat-Allis, Kässbohrer, MAN,
 Mercedes-Benz, Mitsubishi, Neoplan,
 Ssangyong

 B+ M12, B- M10, Total length 407.00,
 Drive type Steel, Gear type DD,
 Mount. holes 3 (0)

A: 92.00 B: 48.50 mm

110214 Starter 24 V, 6.6 kW

Replacing: 2998006

Servicing: Scania

 B+ M10, B- M10, Total length 407.00,
 Drive type Steel, Gear type DD,
 Mount. holes 3 (0), Insulated return

A: 92.00 B: 37.00 mm

110518 Starter 24 V, 4.0 kW

Replacing: 2998201

Servicing: BENFRA, Fiat, Fiat-Allis, Iveco

 B+ M10, Total length 342.00,
 Drive type Steel, Gear type DD,
 Mount. holes 3 (0)

A: 110.00 B: 27.00 mm

110524 Starter 24 V, 4.0 kW

Replacing: 2998001

Servicing: Mercedes-Benz

 B+ M10, Total length 341.00,
 Drive type Steel, Gear type DD,
 Mount. holes 3 (0)

A: 89.00 B: 48.00 mm

110525 Starter 12 V, 3.0 kW

Replacing: 2998000

Servicing: Claas, Mercedes-Benz

 B+ M10, Total length 341.00,
 Drive type Steel, Gear type DD,
 Mount. holes 3 (0)

A: 89.00 B: 48.00 mm

110527 Starter 24 V, 4.0 kW

 Replacing: CA45F24-Y78, 2998004, 2996101,
 1321F904, 1321F780, 1321780

Servicing: Scania, Steyr

 B+ M10, Total length 342.00,
 Drive type Steel, Gear type DD,
 Mount. holes 3 (0)

A: 89.00 B: 46.50 mm

110531 Starter 24 V, 6.6 kW

Replacing: 2998007

 Servicing: Fiat-Allis, Gmeinder, KHD,
 Mercedes-Benz

 B+ M12, B- M10, Total length 405.00,
 Drive type Steel, Gear type DD

A: 56.00 B: 37.00 mm

110998 Starter 24 V, 5.2 kW

Manufacturer: Prestolite

 Replacing: S115A24-9, S11524-9,
 CA45H24-18, CA45G24-18, CA45F24-18,
 CA45D24-18, CA4524-18, 1327A491, 1327A490

Servicing: DAF, Ford

 B+ M8, Total length 166.00,
 Drive type Steel, Gear type DD,
 Mount. holes 3 (0)

A: 92.00 B: 21.00 mm



111638 Starter 24 V, 4.0 kW

Replacing: 2998002

Servicing: Volvo

B+ M10, Total length 308.00,
Drive type Steel, Gear type DD,
Mount. holes 3 (0)

A: 89.00 B: 47.70 mm

110999 Starter 24 V

Replacing: 228000-0070, 128000-7520, 128000-7510

Servicing: Case, Caterpillar, Fiat-Allis, Peterbilt Trucks, Various, Volvo

 B+ M12, B- M12, Total length 499.50, Drive type Steel, Gear type DD, Mount. holes 3 (0), Insulated return, Oil sealed
 Replacing: 42MT.

A: 92.00 B: 46.50 mm

111679 Starter 24 V, 4.5 kW

Replacing: 228000-1601, 228000-1600, 128000-8621, 128000-8620

Servicing: Toyota

B+ M10, Total length 292.00, Drive type Steel, Gear type GR, Mount. holes 2 (0)

A: 91.00 B: 17.00 mm

112089 Starter 12 V

Replacing: 228000-1211, 228000-1210, 128000-1340

Servicing: Case, Caterpillar, Cummins, Ford, Freightliner, International, Kenworth, Mack, New Holland, Perkins, Volvo

 B+ M12, B- M12, 15a M5, Total length 500.00, Drive type Steel, Gear type DD, Clutch type Wet, Mount. holes 3 (0), Insulated return, Oil sealed
 Replacing: 42MT.

A: 92.00 B: 46.00 mm

112822 Starter 24 V, 4.5 kW

Replacing: 228000-5641, 228000-5640

Servicing: Iveco

B+ M10, Total length 293.00, Drive type Steel, Gear type GR, Clutch type Wet, Mount. holes 3 (0)

A: 89.00 B: 49.00 mm

112823 Starter 24 V, 5.5 kW

Replacing: 228000-7551, 228000-7550

Servicing: Iveco

B+ M10, Total length 315.00, Drive type Steel, Gear type GR, Clutch type Wet, Mount. holes 3 (0)

A: 92.00 B: 49.00 mm

113131# Starter 12 V, 3.0 kW

Replacing: 128000-0494, 128000-0492, 128000-0491, 128000-0490

Servicing: Isuzu

B+ M10, Total length 319.50, Drive type Steel, Gear type GR, Mount. holes 3 (0)

A: 105.00 B: 40.50 mm

113214# Starter 12 V, 2.5 kW

Replacing: 128000-5301, 128000-5300, 128000-5091, 128000-5090, 028000-9770, 028000-9160

Servicing: Hino

B+ M10, Total length 296.00, Drive type Steel, Gear type GR, Mount. holes 2 (1)

A: 105.00 B: 31.00 mm

113428 Starter 12 V, 2.5 kW

Replacing: 128000-7753, 128000-7752, 128000-7751, 128000-7750, 028000-6561, 028000-6560, 028000-5490

Servicing: Isuzu

B+ M10, Total length 297.00, Drive type Steel, Gear type GR, Mount. holes 3 (0)

A: 105.00 B: 41.00 mm

113550 Starter 12 V

Replacing: 428000-1221, 428000-1220, 428000-1211, 428000-1210

Servicing: Mack

 B+ M12, Total length 402.80, Drive type Steel, Gear type GR, Mount. holes 3 (0), Insulated return
 Replacing: 39MT.

A: 92.00 B: 46.00 mm

114017 Starter 24 V, 5.5 kW

Replacing: 128000-4688, 128000-4687, 128000-4686, 128000-4685

Servicing: Hino

B+ M10, Total length 326.00, Drive type Steel, Gear type GR, Mount. holes 3 (0)

A: 100.00 B: 25.00 mm

114337 Starter 12 V, 4.5 kW

Replacing: 028000-9140

Servicing: Hino

B+ M10, Total length 296.60

A: 100.00 B: 64.00 mm

114346 Starter 24 V, 5.5 kW

Replacing: 128000-4251

Servicing: Isuzu, TCM

B+ M10, Total length 316.80, Drive type Steel, Mount. holes 2 (0)

A: 105.00 B: 57.00 mm



110459 Starter 12 V, 2.8 kW

Replacing: 538504

Servicing: Bedford

B+ M8, Total length 335.00,

Drive type Steel, Gear type DD,

Mount. holes 3 (0)

A: 89.00 B: 47.50 mm



110205 Starter 24 V, 6.5 kW
 Replacing: R22.22, 0220000
 Servicing: Volvo
 B+ M10, Total length 407.00,
 Drive type Steel, Gear type DD,
 Mount. holes 3 (0), Waterproof
 A: 89.00 B: 47.50 mm



110206 Starter 24 V, 5.4 kW
 Replacing: R23.08, 6080000
 Servicing: Claas, Fiat-Allis, Kässbohrer, MAN,
 Mercedes-Benz, Neoplan, Setra
 B+ M12, B- M10, Total length 390.00,
 Drive type Steel, Gear type DD,
 Mount. holes 3 (0)
 A: 92.00 B: 47.50 mm



110207 Starter 24 V, 5.4 kW
 Replacing: R23.10, 6100000
 Servicing: Volvo, Volvo BM
 B+ M10, B- M10, Total length 387.00,
 Drive type Steel, Gear type DD,
 Mount. holes 3 (0)
 A: 89.00 B: 47.00 mm



110208 Starter 24 V, 5.4 kW
 Replacing: R23.11, 6110000
 Servicing: Fiat-Allis, Mercedes-Benz, Steyr,
 Volvo
 B+ M10, B- M10, Total length 387.00,
 Drive type Steel, Gear type DD,
 Mount. holes 3 (0), Oil sealed, Waterproof
 A: 89.00 B: 48.50 mm



110209 Starter 24 V, 5.4 kW
 Replacing: R23.23, 6230000
 Servicing: DAF
 B+ M12, B- M10, Total length 387.00,
 Drive type Steel, Gear type DD,
 Mount. holes 3 (0)
 A: 89.00 B: 47.00 mm



110210 Starter 24 V, 6.6 kW
 Replacing: R23.05, R22.05, R20.42, 6050000,
 0050000
 Servicing: Fiat-Allis, Kässbohrer, MAN,
 Mercedes-Benz, Mitsubishi, Neoplan,
 Ssangyong
 B+ M12, B- M10, Total length 407.00,
 Drive type Steel, Gear type DD,
 Mount. holes 3 (0)
 A: 92.00 B: 48.50 mm



110212 Starter 24 V, 6.6 kW
 Replacing: R23.26, R22.16, R22.14, 6260000,
 0160000, 0140000
 Servicing: Iveco, Scania
 B+ M10, B- M10, Total length 407.00,
 Drive type Steel, Gear type DD,
 Mount. holes 3 (0)
 A: 92.00 B: 47.65 mm



110213 Starter 24 V, 6.6 kW
 Replacing: R22.07, 0070000
 Servicing: Fiat, Iveco
 B+ M12, B- M10, Total length 407.00,
 Drive type Steel, Gear type DD,
 Mount. holes 3 (0)
 A: 115.00 B: 20.80 mm



110214 Starter 24 V, 6.6 kW
 Replacing: R22.13, R20D1, R20.28, 0130000
 Servicing: Scania
 B+ M10, B- M10, Total length 407.00,
 Drive type Steel, Gear type DD,
 Mount. holes 3 (0), Insulated return
 A: 92.00 B: 37.00 mm



110523 Starter 24 V, 4.8 kW
 Replacing: R10.08, 6090000
 Servicing: ABG, Ahlmann, Case, Compair,
 Iveco, KHD, Payloader
 B+ M10, Drive type Steel, Gear type DD,
 Mount. holes 3 (0)
 A: 89.00 B: 27.50 mm



110531 Starter 24 V, 6.6 kW
 Replacing: R22.12, R22.10, 6220000,
 0120000, 0100000, 0090000
 Servicing: Fiat-Allis, Gmeinder, KHD,
 Mercedes-Benz
 B+ M12, B- M10, Total length 405.00,
 Drive type Steel, Gear type DD
 A: 56.00 B: 37.00 mm



110532 Starter 24 V, 6.6 kW
 Replacing: R20W, R20.24
 Servicing: Iveco
 B+ M10, B- M10, Total length 405.00,
 Drive type Steel, Gear type DD,
 Mount. holes 3 (0), Waterproof
 A: 115.00 B: 21.00 mm



110533 Starter 24 V, 5.4 kW
 Replacing: R23.09
 Servicing: Steyr
 B+ M10, B- M10, Total length 387.00,
 Drive type Steel, Gear type DD,
 Mount. holes 3 (0)
 A: 89.00 B: 46.50 mm



110534 Starter 24 V, 5.4 kW
 Replacing: R23.18, 6180000
 Servicing: Ford, Iveco, Various Agriculture
 Vehicles
 B+ M10, Total length 390.00, Drive type Steel,
 Gear type DD, Mount. holes 3 (0)
 A: 89.00 B: 47.00 mm



110535 Starter 24 V, 5.4 kW
 Replacing: R23.21, 6210000
 Servicing: Iveco
 B+ M10, B- M10, Total length 384.00,
 Drive type Steel, Gear type DD,
 Mount. holes 3 (0)
 A: 89.00 B: 47.00 mm



110536 Starter 12 V, 2.7 kW
 Replacing: R11K, R11.12
 Servicing: ABG, Atlas Copco, Bobcat, Bomag,
 Bosch, Case, Claas, Deutz-Fahr, Fendt, Irmer,
 Iveco, KHD, Kramer, Mercedes-Benz
 B+ M10, Total length 234.00,
 Drive type Steel, Gear type GR,
 Mount. holes 3 (0)
 A: 89.00 B: 28.00 mm



110582 Starter 24 V, 5.4 kW
 Replacing: R23.06, 6060000
 Servicing: Iveco
 B+ M10, B- M10, Total length 384.00,
 Drive type Steel, Gear type DD,
 Mount. holes 3 (0)
 A: 92.00 B: 47.00 mm



110601 Starter 24 V, 5.4 kW
 Replacing: R23.13, 6130000
 Servicing: Mercedes-Benz, Steyr
 B+ M10, Total length 384.25,
 Drive type Steel, Gear type DD,
 Mount. holes 3 (0)
 A: 88.85 B: 47.50 mm



110932 Starter 24 V, 5.4 kW
 Replacing: R23.24
 Servicing: DAF
 B+ M10, B- M10, Total length 384.50,
 Drive type Steel, Gear type DD,
 Mount. holes 3 (0), Insulated return
 A: 88.85 B: 47.00 mm



110980 Starter 24 V, 5.4 kW
 Replacing: R23.34, 6340000
 Servicing: Volvo
 B+ M10, B- M10, Total length 387.00,
 Drive type Steel, Gear type DD,
 Mount. holes 3 (0)
 A: 92.00 B: 47.00 mm



111046 Starter 24 V, 6.6 kW
 Replacing: R22.06, 0060000
 Servicing: MAN, Volvo
 B+ M10, Total length 404.00,
 Drive type Steel, Gear type DD,
 Mount. holes 3 (0)
 A: 88.85 B: 48.00 mm



111231 Starter 24 V, 6.6 kW
 Replacing: R22.38, 0380000
 Servicing: Renault V.I.
 B+ M10, B- M10, Total length 405.00,
 Drive type Steel, Gear type DD,
 Mount. holes 3 (0), Insulated return
 A: 89.00 B: 40.25 mm



111249 Starter 24 V, 5.4 kW
 Replacing: R23.14, 6140000
 Servicing: Various Industrial applications
 B+ M10, Total length 381.80,
 Drive type Bronze, Gear type DD,
 Mount. holes 3 (0), Waterproof
 A: 89.00 B: 48.25 mm

110465 Starter 12 V, 2.8 kW

Replacing: 1624968, 1526103

Servicing: Ford

 B+ M8, Total length 309.00,
 Drive type Steel, Gear type DD,
 Mount. holes 3 (0)

A: 92.00 B: 20.00 mm

110535 Starter 24 V, 5.4 kW

Replacing: D6PZ11350C, C9JF11350A

Servicing: Iveco

 B+ M10, B- M10, Total length 384.00,
 Drive type Steel, Gear type DD,
 Mount. holes 3 (0)

A: 89.00 B: 47.00 mm

110998 Starter 24 V, 5.2 kW

Manufacturer: Prestolite

Replacing: 82DB11000FA

Servicing: DAF, Ford

 B+ M8, Total length 166.00,
 Drive type Steel, Gear type DD,
 Mount. holes 3 (0)

A: 92.00 B: 21.00 mm

112089 Starter 12 V

 Replacing: SA768A, E8HZ11002HA,
 E8HZ11002A, E8HT11001AA, E6HZ11002D,
 E6HZ11002C, E6HT11001CA, C6TZ11002E

 Servicing: Case, Caterpillar, Cummins, Ford,
 Freightliner, International, Kenworth, Mack,
 New Holland, Perkins, Volvo

 B+ M12, B- M12, 15a M5,
 Total length 500.00, Drive type Steel,
 Gear type DD, Clutch type Wet,
 Mount. holes 3 (0), Insulated return, Oil
 sealed

Replacing: 42MT.

A: 92.00 B: 46.00 mm

112253 Starter 12 V, 2.5 kW

 Replacing: F7HT11002FH, F7HT11001FA,
 F4HT11001BA, F3HZ11002B, F3HZ11001B,
 F3HT11001DC, F3HT11001DB

Servicing: Ford, Ingersoll Rand

 B+ M10, Total length 342.00,
 Drive type Steel, Gear type GR,
 Clutch type Dry, Mount. holes 3 (0)
 Replacing: 28MT.

A: 88.80 B: 45.00 mm

112603 Starter 12 V, 1.5 kW

 Replacing: SA885, SA855, SA-885, SA-855,
 F7PZ11002EA, F7PZ-11002-EA, F7PU11000EA,
 F7PU-11000-EA

Servicing: Ford

 B+ M8, Total length 225.50,
 Drive type Steel, Gear type GR,
 Clutch type Wet, Mount. holes 2 (0)

A: 105.00 B: 12.00 mm

113125 Starter 12 V

 Replacing: SA764A, SA-764A, E9HZ11002A,
 E9HT11001BA

Servicing: Ford, New Holland

 B+ 1/2" UNC, Total length 401.50,
 Drive type Steel, Gear type DD,
 Clutch type Wet, Mount. holes 3 (0), Oil
 sealed

Replacing: 37MT, 41MT.

A: 92.00 B: 48.25 mm

113703 Starter 12 V, 3.6 kW

 Replacing: 6C2Z11002A, 6C2T11000AA,
 6C2T11000A, 3C3Z11002AA, 3C3Z11002A,
 3C3U11000AC, 3C3U11000AB

Servicing: Ford

 B+ M10, Total length 248.00,
 Drive type Steel, Gear type GR,
 Mount. holes 2 (1)

A: 76.00 B: 47.00 mm



110576 Starter 24 V, 3.2 kW

Replacing: HSG232500

Servicing: Mitsubishi

B+ M8, Total length 243.00,

Drive type Steel, Gear type GR,

Mount. holes 2 (0)

A: 60.00 B: 19.40 mm

110277 Starter 12 V, 0.8 kW

Replacing: S114-426, S114-348A, S114-348, S114-229F, S114-229E, S114-229, S114-173F, S114-173E, S114-173B

Servicing: Nissan

B+ M8, Total length 190.00, Drive type Steel, Gear type DD, Mount. holes 2 (0)

A: 82.35 B: 6.80 mm

110719 Starter 12 V, 2.0 kW

Replacing: S13-92A, S13-92, S13-63, S13-45B, S13-45A, S13-45, S13-40B, S13-40A, S13-40, S13-34A, S13-34

Servicing: Nissan

B+ M8, Total length 227.50, Drive type Steel, Gear type GR, Mount. holes 2 (0)

A: 82.45 B: 11.50 mm

112365 Starter 12 V, 2.2 kW

Replacing: S13-327A, S13-326, S13-322, S13-126A, S13-126, S13-122

Servicing: Nissan

B+ M8, Total length 224.00, Drive type Steel, Gear type GR, Clutch type Wet, Mount. holes 2 (0)

A: 95.00 B: 10.50 mm

110386 Starter 12 V, 1.9 kW

Replacing: S13-38B, S13-38A, S13-36, S12-68D, S12-68C, S12-68B, S12-68A, S12-68, S12-63C, S12-63B, S12-63A

Servicing: Nissan

B+ M8, Total length 242.00, Drive type Steel, Gear type GR, Mount. holes 2 (0)

A: 82.50 B: 10.50 mm

110723 Starter 24 V, 3.5 kW

Replacing: S25-212, S25-120A, S25-120, S24-13, S24-03C, S24-03B, S24-03A

Servicing: Isuzu

B+ M8, Total length 240.00, Drive type Steel, Gear type GR, Mount. holes 2 (0)

A: 94.90 B: 21.00 mm

113210 Starter 24 V, 3.2 kW

Replacing: S25-303A, S25-303, S25-302, S25-125B, S25-125A, S25-125, S24-01D, S24-01C, S24-01B, S24-01

Servicing: Nissan

B+ M8, Total length 240.00, Drive type Steel, Gear type DD/GR, Mount. holes 3 (0)

A: 105.00 B: 11.00 mm

110574 Starter 12 V, 2.0 kW

Replacing: S14-205A, S14-205, S13-327, S13-307A, S13-213, S13-212, S13-106E, S13-106C, S13-106B, S13-106A

Servicing: Nissan

B+ M8, Total length 224.00, Drive type Steel, Gear type GR, Mount. holes 2 (0)

A: 94.90 B: 11.00 mm

111247 Starter 24 V, 3.5 kW

Replacing: S25-121A, S25-121, S24-07

Servicing: Isuzu

B+ M8, Total length 243.25, Drive type Steel, Gear type GR, Mount. holes 2 (0)

A: 95.00 B: 20.75 mm

113675 Starter 24 V, 4.0 kW

Replacing: S25-505G, S25-505E, S25-505C, S25-505A, S25-505, S25-501C, S25-501B, S25-501A, S25-501, S25-171

Servicing: Isuzu, Nissan

B+ M8, Total length 235.50, Drive type Steel, Gear type GR, Clutch type Dry, Mount. holes 2 (0)

A: 92.00 B: 44.10 mm

110616 Starter 24 V, 4.5 kW

Replacing: S25-75A, S25-75, S25-64F, S25-64E, S25-64B, S25-64, S25-164A, S25-164, S25-162, S25-110M, S25-110L

Servicing: Nissan

B+ M8, Total length 292.00, Drive type Steel, Gear type GR, Mount. holes 3 (0)

A: 105.00 B: 33.80 mm

111805 Starter 12 V, 2.5 kW

Replacing: S13-127C, S13-127A, S13-127, S13-107A, S13-107

Servicing: Ford, Nissan

B+ M8, Total length 228.00, Drive type Steel, Gear type GR, Mount. holes 2 (0)

A: 95.00 B: 11.50 mm

114422 Starter 24 V, 6.0 kW

Replacing: S210-100

Servicing: Nissan

B+ M10, Total length 324.50, Drive type Steel, Mount. holes 3 (0)

A: 122.00 B: 41.00 mm

110205 Starter 24 V, 6.5 kW

Replacing: AZK5187, 11.139.028

Servicing: Volvo

 B+ M10, Total length 407.00,
 Drive type Steel, Gear type DD,
 Mount. holes 3 (0), Waterproof

A: 89.00 B: 47.50 mm

110206 Starter 24 V, 5.4 kW

 Replacing: AZK5545, AZK5401, 11.139.506,
 11.130.041

 Servicing: Claas, Fiat-Allis, Kässbohrer, MAN,
 Mercedes-Benz, Neoplan, Setra

 B+ M12, B- M10, Total length 390.00,
 Drive type Steel, Gear type DD,
 Mount. holes 3 (0)

A: 92.00 B: 47.50 mm

110207 Starter 24 V, 5.4 kW

Replacing: 11.139.106

Servicing: Volvo, Volvo BM

 B+ M10, B- M10, Total length 387.00,
 Drive type Steel, Gear type DD,
 Mount. holes 3 (0)

A: 89.00 B: 47.00 mm

110210 Starter 24 V, 6.6 kW

Replacing: AZK5191, 11.139.032

 Servicing: Fiat-Allis, Kässbohrer, MAN,
 Mercedes-Benz, Mitsubishi, Neoplan,
 Ssangyong

 B+ M12, B- M10, Total length 407.00,
 Drive type Steel, Gear type DD,
 Mount. holes 3 (0)

A: 92.00 B: 48.50 mm

110212 Starter 24 V, 6.6 kW

Replacing: AZK5172, 11.139.012

Servicing: Iveco, Scania

 B+ M10, B- M10, Total length 407.00,
 Drive type Steel, Gear type DD,
 Mount. holes 3 (0)

A: 92.00 B: 47.65 mm

110213 Starter 24 V, 6.6 kW

Replacing: AZK5179, 11.139.020

Servicing: Fiat, Iveco

 B+ M12, B- M10, Total length 407.00,
 Drive type Steel, Gear type DD,
 Mount. holes 3 (0)

A: 115.00 B: 20.80 mm

110368 Starter 12 V, 2.3 kW

 Replacing: AZJ3567, AZJ3312, AZJ3311,
 AZJ3107, 11.130.886, 11.130.885,
 11.130.399, 11.130.300

Servicing: Audi, Mercedes-Benz, Volvo

 B+ M10, Total length 289.00,
 Drive type Steel, Gear type DD,
 Mount. holes 2 (2)

A: 82.50 B: 21.00 mm

110409 Starter 12 V, 3.0 kW

Replacing: AZK5487, 11.139.140

Servicing: Kaelble, Mack, Sennebogen

 B+ M10, Total length 384.00,
 Drive type Steel, Gear type DD,
 Mount. holes 3 (0)

A: 89.00 B: 47.00 mm

110464 Starter 12 V, 2.1 kW

Replacing: AZJ3324, 11.130.795

 Servicing: Carbodies, DAF, Lancer Boss,
 Various Agriculture Vehicles

 B+ M8, Total length 336.50,
 Drive type Steel, Gear type DD,
 Mount. holes 3 (0)

A: 89.00 B: 29.50 mm

110517 Starter 24 V, 3.2 kW

 Replacing: AZJ3542, AZJ3520, 11.130.216,
 11.130.146

Servicing: BENFRA, Fiat-Allis, Iveco

 B+ M10, Total length 295.00,
 Drive type Steel, Gear type DD,
 Mount. holes 3 (0)

A: 110.00 B: 27.00 mm

110518 Starter 24 V, 4.0 kW

 Replacing: AZJ3515, AZJ3460, AZJ3131,
 11.139.454, 11.130.490, 11.130.124

Servicing: BENFRA, Fiat, Fiat-Allis, Iveco

 B+ M10, Total length 342.00,
 Drive type Steel, Gear type DD,
 Mount. holes 3 (0)

A: 110.00 B: 27.00 mm

110519 Starter 12 V, 3.0 kW

Replacing: AZJ3299, 11.130.862

Servicing: Iveco, Volvo

 B+ M10, Total length 340.50,
 Drive type Steel, Gear type DD,
 Mount. holes 3 (0)

A: 89.00 B: 48.00 mm

110521 Starter 24 V, 4.0 kW

Replacing: AZJ3546, AZJ3459, AZJ3133, AZF3542, 11.139.453, 11.130.492, 11.130.225
 Servicing: BENFRA, Fiat, Fiat-Allis, Iveco
 B+ M10, Total length 343.00, Drive type Steel, Gear type DD, Mount. holes 3 (0)
 A: 110.00 B: 27.00 mm

110523 Starter 24 V, 4.8 kW

Replacing: AZJ3518, AZJ3132, 11.130.491, 11.130.172, 11.130.141, 11.130.075
 Servicing: ABG, Ahlmann, Case, Compair, Iveco, KHD, Payloader
 B+ M10, Drive type Steel, Gear type DD, Mount. holes 3 (0)
 A: 89.00 B: 27.50 mm

110524 Starter 24 V, 4.0 kW

Replacing: AZJ3589, AZJ3549, AZJ3113, AZJ0501, 11.130.407, 11.130.339, 11.130.230, 11.130.010
 Servicing: Mercedes-Benz
 B+ M10, Total length 341.00, Drive type Steel, Gear type DD, Mount. holes 3 (0)
 A: 89.00 B: 48.00 mm

110525 Starter 12 V, 3.0 kW

Replacing: AZJ3548, AZJ3118, 11.130.412, 11.130.229
 Servicing: Claas, Mercedes-Benz
 B+ M10, Total length 341.00, Drive type Steel, Gear type DD, Mount. holes 3 (0)
 A: 89.00 B: 48.00 mm

110527 Starter 24 V, 4.0 kW

Replacing: AZJ3263, 11.130.743
 Servicing: Scania, Steyr
 B+ M10, Total length 342.00, Drive type Steel, Gear type DD, Mount. holes 3 (0)
 A: 89.00 B: 46.50 mm

110535 Starter 24 V, 5.4 kW

Replacing: AZK5173, 11.139.013
 Servicing: Iveco
 B+ M10, B- M10, Total length 384.00, Drive type Steel, Gear type DD, Mount. holes 3 (0)
 A: 89.00 B: 47.00 mm

110536 Starter 12 V, 2.7 kW

Replacing: AZJ3508, AZJ3170, AZJ3169, AZJ3128, AZJ0402, 11.130.552, 11.130.551, 11.130.484, 11.130.117
 Servicing: ABG, Atlas Copco, Bobcat, Bomag, Bosch, Case, Claas, Deutz-Fahr, Fendt, Irmer, Iveco, KHD, Kramer, Mercedes-Benz
 B+ M10, Total length 234.00, Drive type Steel, Gear type GR, Mount. holes 3 (0)
 A: 89.00 B: 28.00 mm

110601 Starter 24 V, 5.4 kW

Replacing: AZK5193, AZK5117, AZK5113, 11.139.034, 11.130.005, 10.130.121
 Servicing: Mercedes-Benz, Steyr
 B+ M10, Total length 384.25, Drive type Steel, Gear type DD, Mount. holes 3 (0)
 A: 88.85 B: 47.50 mm

110640 Starter 12 V, 3.0 kW

Replacing: AZJ3534, AZJ3516, AZJ3115, 11.130.409, 11.130.198, 11.130.127
 Servicing: Allis Chalmers, Fiat, Fiat-Allis, Long
 B+ M10, Total length 310.00, Drive type Steel, Gear type DD, Mount. holes 3 (0)
 A: 110.00 B: 26.00 mm

110980 Starter 24 V, 5.4 kW

Replacing: AZK5188, 11.139.029
 Servicing: Volvo
 B+ M10, B- M10, Total length 387.00, Drive type Steel, Gear type DD, Mount. holes 3 (0)
 A: 92.00 B: 47.00 mm

110981 Starter 24 V, 5.4 kW

Replacing: AZK5553, AZK5184, 11.139.514, 11.139.025
 Servicing: DAF
 B+ M12, B- M10, Total length 387.00, Drive type Steel, Gear type DD, Mount. holes 3 (0)
 A: 110.00 B: 47.50 mm

111217 Starter 12 V, 3.0 kW

Replacing: AZK5511, AZK5457, AZK5449, AZK5192, AZK5112, 11.139.108, 11.139.098, 11.139.033, 11.130.142
 Servicing: Volvo, Volvo BM
 B+ M10, B- M10, Total length 386.50, Drive type Steel, Gear type DD, Mount. holes 3 (0)
 A: 89.00 B: 48.00 mm



111231 Starter 24 V, 6.6 kW
 Replacing: AZK5189, 184452, 11.139.030
 Servicing: Renault V.I.
 B+ M10, B- M10, Total length 405.00,
 Drive type Steel, Gear type DD,
 Mount. holes 3 (0), Insulated return
 A: 89.00 B: 40.25 mm



111793 Starter 12 V, 3.0 kW
 Replacing: 11.131.065
 Servicing: Caterpillar, Mercedes-Benz, Volvo
 B+ M10, Total length 342.00,
 Drive type Steel, Gear type DD,
 Clutch type Dry, Mount. holes 3 (0)
 A: 88.80 B: 28.50 mm



111982 Starter 24 V, 4.0 kW
 Replacing: AZF4507, 11.130.728
 Servicing: Mercedes-Benz
 B+ M10, Total length 342.00,
 Drive type Steel, Gear type GR,
 Mount. holes 3 (0)
 A: 88.75 B: 45.00 mm



111638 Starter 24 V, 4.0 kW
 Replacing: AZJ3231, 11.130.687
 Servicing: Volvo
 B+ M10, Total length 308.00,
 Drive type Steel, Gear type DD,
 Mount. holes 3 (0)
 A: 89.00 B: 47.70 mm



111805 Starter 12 V, 2.5 kW
 Replacing: AZE4634, 11.139.406
 Servicing: Ford, Nissan
 B+ M8, Total length 228.00,
 Drive type Steel, Gear type GR,
 Mount. holes 2 (0)
 A: 95.00 B: 11.50 mm



112039 Starter 12 V, 2.7 kW
 Replacing: AZJ3192, AZJ3123, 11.130.612,
 11.130.432
 Servicing: Fendt, Jenbacher Werke, KHD,
 Lombardini
 B+ M10, Total length 295.00,
 Drive type Steel, Gear type DD,
 Mount. holes 2 (0)
 A: 82.50 B: 21.00 mm



111640 Starter 24 V, 4.0 kW
 Replacing: AZJ3393, AZJ3387, AZJ3160,
 11.131.177, 11.131.143, 11.130.537
 Servicing: MAN
 B+ M10, Total length 338.50,
 Drive type Steel, Gear type DD,
 Mount. holes 3 (0)
 A: 88.50 B: 28.00 mm



111851 Starter 12 V, 2.0 kW
 Replacing: AZE2206, 11.139.435
 Servicing: Mercedes-Benz
 B+ M8, Total length 240.00,
 Drive type Steel, Gear type GR,
 Mount. holes 2 (2)
 A: 82.50 B: 25.50 mm



112116 Starter 24 V, 6.6 kW
 Replacing: AZK5456, 11.139.107
 Servicing: Volvo
 B+ M12, B- M12, Total length 407.00,
 Drive type Steel, Gear type DD,
 Mount. holes 3 (0), Insulated return
 A: 92.00 B: 47.00 mm



111771 Starter 24 V, 6.2 kW
 Replacing: AZG4605, 11.131.016
 Servicing: Mercedes-Benz
 B+ M12, Total length 405.00,
 Drive type Steel, Gear type DD,
 Mount. holes 3 (0)
 A: 92.00 B: 47.00 mm



111910 Starter 24 V, 6.7 kW
 Replacing: AZJ3450, 11.139.164
 Servicing: Scania
 B+ M12, 30h M12, Total length 429.00,
 Drive type Steel, Gear type DD,
 Clutch type Dry, Mount. holes 3 (0), Not
 Insulated return
 A: 92.00 B: 47.00 mm



112119 Starter 24 V, 6.6 kW
 Replacing: AZK5181, 11.139.022
 Servicing: Scania
 B+ M10, B- M10, Total length 406.00,
 Drive type Steel, Gear type DD,
 Mount. holes 3 (0)
 A: 92.00 B: 37.00 mm

112494 Starter 24 V, 4.0 kW

Replacing: AZF4515, AZF4198, 11.131.770, 11.130.842

Servicing: Volvo

 B+ M10, Total length 316.00,
 Drive type Steel, Gear type GR,
 Clutch type Dry, Mount. holes 3 (0)

A: 89.00 B: 29.00 mm

112651 Starter 24 V, 4.8 kW

Replacing: AZJ3221, AZJ0602, 11.130.672, 11.130.030, 11.130.003

Servicing: Bosch, KHD

 B+ M10, Total length 351.50,
 Drive type Steel, Gear type DD,
 Mount. holes 3 (0)

A: 89.00 B: 48.00 mm

113464 Starter 24 V, 4.0 kW

Replacing: AZJ3522, AZJ3222, 11.130.673, 11.130.151

Servicing: ABG, Irmer, Iveco, KHD

 B+ M10, Total length 346.50,
 Drive type Steel, Gear type DD,
 Clutch type Dry, Mount. holes 3 (0)

A: 89.00 B: 28.80 mm

112498 Starter 24 V, 4.0 kW

Replacing: AZF4237, 11.131.846

Servicing: Iveco

 B+ M10, Total length 315.00,
 Drive type Steel, Gear type DD,
 Clutch type Dry, Mount. holes 3 (0)

A: 88.75 B: 49.00 mm

112670 Starter 24 V, 4.0 kW

Replacing: AZJ3351, 11.130.993

 Servicing: DAF, Hanomag, Mercedes-Benz,
 Perkins

 B+ M10, Total length 341.00,
 Drive type Steel, Gear type DD,
 Mount. holes 3 (0)

A: 88.80 B: 28.50 mm

113465 Starter 12 V, 3.0 kW

Replacing: AZJ3187, 11.130.596

Servicing: Renault V.I.

 B+ M10, Total length 338.00,
 Drive type Steel, Gear type DD,
 Clutch type Dry, Mount. holes 3 (0)

A: 88.75 B: 21.50 mm

112534 Starter 12 V, 2.0 kW

Replacing: AZE2155, 11.131.267

Servicing: JCB, KHD, Perkins

 B+ M8, Total length 239.00,
 Drive type Steel, Gear type GR,
 Mount. holes 2 (0)

A: 74.00 B: 18.00 mm

113356 Starter 24 V, 3.5 kW

Replacing: AZJ3223, 11.130.676

Servicing: Belarus, GAZ, ZIL

 B+ M10, Total length 235.00,
 Drive type Steel, Gear type GR,
 Mount. holes 3 (0)

A: 99.90 B: 32.00 mm

113466 Starter 24 V, 4.0 kW

 Replacing: AZJ3188, AZF4527, AZF4508,
 11.130.944, 11.130.729, 11.130.598

Servicing: Renault V.I.

 B+ M10, Total length 316.00,
 Drive type Steel, Gear type DD/GR,
 Clutch type Dry, Mount. holes 3 (0)

A: 88.90 B: 22.00 mm

112581 Starter 24 V, 6.2 kW

 Replacing: AZJ3452, AZJ3448, 11.139.165,
 11.139.163

Servicing: DAF

 B+ M12, Total length 380.00,
 Drive type Steel, Gear type DD,
 Mount. holes 3 (0)

A: 110.00 B: 48.00 mm

113389 Starter 12 V, 2.2 kW

Replacing: AZE4140, 11.139.441

Servicing: Mercedes-Benz

 B+ M8, Total length 272.50,
 Drive type Steel, Gear type GR,
 Mount. holes 2 (2)

A: 82.40 B: 25.00 mm

113467 Starter 12 V, 3.7 kW

Replacing: AZJ3196, 11.130.619

Servicing: Atlas Copco, Deutz-Fahr, Iveco

 B+ M10, Total length 346.00,
 Drive type Steel, Gear type DD,
 Clutch type Dry, Mount. holes 3 (0)

A: 88.80 B: 28.00 mm

113468 Starter 24 V, 4.0 kW

Replacing: AZJ3404, AZJ3388, AZJ3374, AZJ3199, 11.131.236, 11.131.144, 11.131.085, 11.130.626

Servicing: MAN

 B+ M10, Total length 340.00,
 Drive type Steel, Gear type DD,
 Clutch type Dry, Mount. holes 3 (0)
 Bosch GR HC-CARGO 112446.

A: 89.00 B: 27.00 mm

114702 Starter 24 V, 4.0 kW

Replacing: AZF4554, AZF4199, 11.131.775, 11.131.150

Servicing: Kamaz

 B+ M10, Total length 321.00,
 Gear type DD, Mount. holes 3 (0)

A: 92.00 B: 47.00 mm

114435 Starter 24 V, 7.5 kW

Replacing: AZF4828, 11.132.090

Servicing: Howo, Sino, Steyr

 B+ M10, Total length 365.50,
 Drive type Steel, Mount. holes 3 (0)

A: 88,80 B: 47,00 mm

114480 Starter 12 V, 4.2 kW

Manufacturer: Iskra/Mahle

Replacing: AZF4687, 11.131.830

Servicing: Case IH

 B+ M12, Total length 327.00,
 Gear type GR, Mount. holes 3 (0), Oil sealed

A: 92.00 B: 48.00 mm



112253 Starter 12 V, 2.5 kW

Replacing: 4502ME

Servicing: Ford, Ingersoll Rand

B+ M10, Total length 342.00,

Drive type Steel, Gear type GR,

Clutch type Dry, Mount. holes 3 (0)

Replacing: 28MT.

A: 88.80 B: 45.00 mm

110368 Starter 12 V, 2.3 kW

Replacing: 26025016A

 Servicing: Audi, Mercedes-Benz, Volvo
 B+ M10, Total length 289.00, Drive type Steel,
 Gear type DD, Mount. holes 2 (2)

A: 82.50 B: 21.00 mm

110459 Starter 12 V, 2.8 kW

 Replacing: NSB532, 27545, 27543D, 27543A,
 27543, 27443, 26420, 26416E, 26416D,
 26416A, 26416, 26349H, 26349D

Servicing: Bedford

 B+ M8, Total length 335.00, Drive type Steel,
 Gear type DD, Mount. holes 3 (0)

A: 89.00 B: 47.50 mm

110460 Starter 12 V, 2.8 kW

 Replacing: 27559E, 27559A, 27559, 27537B,
 27537A, 27537, 27519D, 27519A, 27519,
 27503D, 27503A, 26436B, 26436A

 Servicing: Atlas Copco, Dronningborg, JCB,
 Massey Ferguson

 B+ M8, Total length 307.50, Drive type Steel,
 Gear type DD, Mount. holes 3 (0)

A: 89.00 B: 29.50 mm

110464 Starter 12 V, 2.1 kW

 Replacing: NSB515, LRS138, 27489, 27476,
 27465, 27419D, 27419A, 27419, 26286J,
 26286H, 26286F, 26286E, 26286A

 Servicing: Carbodyes, DAF, Lancer Boss,
 Various Agriculture Vehicles

 B+ M8, Total length 336.50, Drive type Steel,
 Gear type DD, Mount. holes 3 (0)

A: 89.00 B: 29.50 mm

110465 Starter 12 V, 2.8 kW

 Replacing: NSB535, 27554B, 27554A, 27554,
 27511A, 27511, 26431B, 26431A, 26431,
 26360, 26342L, 26342B, 26341J

Servicing: Ford

 B+ M8, Total length 309.00,
 Drive type Steel, Gear type DD,
 Mount. holes 3 (0)

A: 92.00 B: 20.00 mm

110518 Starter 24 V, 4.0 kW

Replacing: 61924031

Servicing: BENFRA, Fiat, Fiat-Allis, Iveco

 B+ M10, Total length 342.00,
 Drive type Steel, Gear type DD,
 Mount. holes 3 (0)

A: 110.00 B: 27.00 mm

110523 Starter 24 V, 4.8 kW

Replacing: 61924051, 26025117A

 Servicing: ABG, Ahlmann, Case, Compair,
 Iveco, KHD, Payloader

 B+ M10, Drive type Steel, Gear type DD,
 Mount. holes 3 (0)

A: 89.00 B: 27.50 mm

110524 Starter 24 V, 4.0 kW

Replacing: 26025136A

Servicing: Mercedes-Benz

 B+ M10, Total length 341.00,
 Drive type Steel, Gear type DD,
 Mount. holes 3 (0)

A: 89.00 B: 48.00 mm

110525 Starter 12 V, 3.0 kW

Replacing: 26417

Servicing: Claas, Mercedes-Benz

 B+ M10, Total length 341.00, Drive type Steel,
 Gear type DD, Mount. holes 3 (0)

A: 89.00 B: 48.00 mm

110536 Starter 12 V, 2.7 kW

Replacing: 61924050

 Servicing: ABG, Atlas Copco, Bobcat, Bomag,
 Bosch, Case, Claas, Deutz-Fahr, Fendt, Irmer,
 Iveco, KHD, Kramer, Mercedes-Benz

 B+ M10, Total length 234.00, Drive type Steel,
 Gear type GR, Mount. holes 3 (0)

A: 89.00 B: 28.00 mm

110640 Starter 12 V, 3.0 kW

Replacing: 27440B, 27440A, 27440, 26394

Servicing: Allis Chalmers, Fiat, Fiat-Allis, Long

 B+ M10, Total length 310.00,
 Drive type Steel, Gear type DD,
 Mount. holes 3 (0)

A: 110.00 B: 26.00 mm

110817 Starter 12 V, 2.1 kW

 Replacing: 27427E, 27427A, 27427, 27424B,
 27424A, 27424, 26310H, 26310F, 26310E,
 26310D, 26310A, 26310, 26285F

Servicing: DAF, Various Agriculture Vehicles

 B+ M8, Total length 315.00,
 Drive type Steel, Gear type DD,
 Mount. holes 3 (0)

A: 88.80 B: 25.00 mm

111573 Starter 12 V, 2.8 kW

Replacing: 27526D, 27526A, 27526, 27513A, 27513, 26376L, 26376K, 26376A, 26376, 26351, 26343K, 26343D, 26343B

Servicing: Avia, JCB, TCM, Various Agriculture Vehicles

B+ M8, Total length 311.00, Drive type Steel, Gear type DD/GR, Mount. holes 3 (0)

A: 101.00 B: 25.50 mm

113380 Starter 12 V, 2.8 kW

Replacing: NSB534, 27553D, 27553A, 27553, 27507B, 27507A, 27507, 27504B, 27504A, 27504, 26430D, 26430A, 26430

Servicing: Ford

B+ M8, B- M8, Total length 307.00, Drive type Steel, Gear type DD, Mount. holes 3 (0)

A: 91.80 B: 20.00 mm

111574 Starter 12 V, 2.8 kW

Replacing: 27595, 27564F, 27564A, 27564, 26025110A

Servicing: ERF, LDV International, Various Agriculture Vehicles

B+ M8, Total length 340.00, Drive type Steel, Gear type DD, Mount. holes 3 (0)

A: 88.75 B: 47.15 mm

112670 Starter 24 V, 4.0 kW

Replacing: 27315E, 27315B, 27315A, 27315, 27311H, 27311E, 27311A, 27311, 27309E, 27309A, 27309, 27301K

Servicing: DAF, Hanomag, Mercedes-Benz, Perkins

B+ M10, Total length 341.00, Drive type Steel, Gear type DD, Mount. holes 3 (0)

A: 88.80 B: 28.50 mm

110213 Starter 24 V, 6.6 kW

Replacing: 63226391, 63226301

Servicing: Fiat, Iveco

 B+ M12, B- M10, Total length 407.00,
 Drive type Steel, Gear type DD,
 Mount. holes 3 (0)

A: 115.00 B: 20.80 mm

110464 Starter 12 V, 2.1 kW

Replacing: 63227489

 Servicing: Carbodies, DAF, Lancer Boss,
 Various Agriculture Vehicles

 B+ M8, Total length 336.50, Drive type Steel,
 Gear type DD, Mount. holes 3 (0)

A: 89.00 B: 29.50 mm

110517 Starter 24 V, 3.2 kW

 Replacing: MT72AB, MT72AA, MT72A,
 63217226, 63217225, 63217201, 30281018

Servicing: BENFRA, Fiat-Allis, Iveco

 B+ M10, Total length 295.00, Drive type Steel,
 Gear type DD, Mount. holes 3 (0)

A: 110.00 B: 27.00 mm

110518 Starter 24 V, 4.0 kW

 Replacing: MT67CB, MT67CA, MT67C,
 63216741, 63216740, 63216703, 30281020,
 063216741010

Servicing: BENFRA, Fiat, Fiat-Allis, Iveco

 B+ M10, Total length 342.00,
 Drive type Steel, Gear type DD,
 Mount. holes 3 (0)

A: 110.00 B: 27.00 mm

110519 Starter 12 V, 3.0 kW

 Replacing: MT68BA, MT68B, 63216833,
 63216802, 4755112, 4737758

Servicing: Iveco, Volvo

 B+ M10, Total length 340.50, Drive type Steel,
 Gear type DD, Mount. holes 3 (0)

A: 89.00 B: 48.00 mm

110521 Starter 24 V, 4.0 kW

 Replacing: MT67DB, MT67DA, MT67D,
 MT67AD, MT67AC, MT67AB, MT67AA, MT67A,
 63224580, 63224170, 63216748

Servicing: BENFRA, Fiat, Fiat-Allis, Iveco

 B+ M10, Total length 343.00, Drive type Steel,
 Gear type DD, Mount. holes 3 (0)

A: 110.00 B: 27.00 mm

110524 Starter 24 V, 4.0 kW

Replacing: 63206704, 063206704010

Servicing: Mercedes-Benz

 B+ M10, Total length 341.00, Drive type Steel,
 Gear type DD, Mount. holes 3 (0)

A: 89.00 B: 48.00 mm

110536 Starter 12 V, 2.7 kW

Replacing: MT74G, MT68T, 943252071010

 Servicing: ABG, Atlas Copco, Bobcat, Bomag,
 Bosch, Case, Claas, Deutz-Fahr, Fendt, Irmer,
 Iveco, KHD, Kramer, Mercedes-Benz

 B+ M10, Total length 234.00,
 Drive type Steel, Gear type GR,
 Mount. holes 3 (0)

A: 89.00 B: 28.00 mm

111217 Starter 12 V, 3.0 kW

Replacing: MT38RA, MT38R, MT38M

Servicing: Volvo, Volvo BM

 B+ M10, B- M10, Total length 386.50,
 Drive type Steel, Gear type DD,
 Mount. holes 3 (0)

A: 89.00 B: 48.00 mm

112039 Starter 12 V, 2.7 kW

Replacing: MT71GB, 63217158, 063217158010

 Servicing: Fendt, Jenbacher Werke, KHD,
 Lombardini

 B+ M10, Total length 295.00,
 Drive type Steel, Gear type DD,
 Mount. holes 2 (0)

A: 82.50 B: 21.00 mm

112498 Starter 24 V, 4.0 kW

Replacing: 63522310

Servicing: Iveco

 B+ M10, Total length 315.00,
 Drive type Steel, Gear type DD,
 Clutch type Dry, Mount. holes 3 (0)

A: 88.75 B: 49.00 mm

113467 Starter 12 V, 3.7 kW

Replacing: 943252216010

Servicing: Atlas Copco, Deutz-Fahr, Iveco

 B+ M10, Total length 346.00,
 Drive type Steel, Gear type DD,
 Clutch type Dry, Mount. holes 3 (0)

A: 88.80 B: 28.00 mm

110205 Starter 24 V, 6.5 kW

Replacing: 9125100

Servicing: Volvo

 B+ M10, Total length 407.00,
 Drive type Steel, Gear type DD,
 Mount. holes 3 (0), Waterproof

A: 89.00 B: 47.50 mm

110209 Starter 24 V, 5.4 kW

Replacing: 9125420

Servicing: DAF

 B+ M12, B- M10, Total length 387.00,
 Drive type Steel, Gear type DD,
 Mount. holes 3 (0)

A: 89.00 B: 47.00 mm

110214 Starter 24 V, 6.6 kW

Replacing: 9125120

Servicing: Scania

 B+ M10, B- M10, Total length 407.00,
 Drive type Steel, Gear type DD,
 Mount. holes 3 (0), Insulated return

A: 92.00 B: 37.00 mm

110206 Starter 24 V, 5.4 kW

Replacing: 9125330, 9125260, 9125220

 Servicing: Claas, Fiat-Allis, Kässbohrer, MAN,
 Mercedes-Benz, Neoplan, Setra

 B+ M12, B- M10, Total length 390.00,
 Drive type Steel, Gear type DD,
 Mount. holes 3 (0)

A: 92.00 B: 47.50 mm

110210 Starter 24 V, 6.6 kW

Replacing: 9125010

 Servicing: Fiat-Allis, Kässbohrer, MAN,
 Mercedes-Benz, Mitsubishi, Neoplan,
 Ssangyong

 B+ M12, B- M10, Total length 407.00,
 Drive type Steel, Gear type DD,
 Mount. holes 3 (0)

A: 92.00 B: 48.50 mm

110464 Starter 12 V, 2.1 kW

Replacing: 91428729

 Servicing: Carbodies, DAF, Lancer Boss,
 Various Agriculture Vehicles

 B+ M8, Total length 336.50,
 Drive type Steel, Gear type DD,
 Mount. holes 3 (0)

A: 89.00 B: 29.50 mm

110207 Starter 24 V, 5.4 kW

Replacing: 9125240

Servicing: Volvo, Volvo BM

 B+ M10, B- M10, Total length 387.00,
 Drive type Steel, Gear type DD,
 Mount. holes 3 (0)

A: 89.00 B: 47.00 mm

110212 Starter 24 V, 6.6 kW

Replacing: 9125460, 9125130

Servicing: Iveco, Scania

 B+ M10, B- M10, Total length 407.00,
 Drive type Steel, Gear type DD,
 Mount. holes 3 (0)

A: 92.00 B: 47.65 mm

110517 Starter 24 V, 3.2 kW

Replacing: 9124320

Servicing: BENFRA, Fiat-Allis, Iveco

 B+ M10, Total length 295.00,
 Drive type Steel, Gear type DD,
 Mount. holes 3 (0)

A: 110.00 B: 27.00 mm

110208 Starter 24 V, 5.4 kW

Replacing: 9125250

 Servicing: Fiat-Allis, Mercedes-Benz, Steyr,
 Volvo

 B+ M10, B- M10, Total length 387.00,
 Drive type Steel, Gear type DD,
 Mount. holes 3 (0), Oil sealed, Waterproof

A: 89.00 B: 48.50 mm

110213 Starter 24 V, 6.6 kW

Replacing: 9125020

Servicing: Fiat, Iveco

 B+ M12, B- M10, Total length 407.00,
 Drive type Steel, Gear type DD,
 Mount. holes 3 (0)

A: 115.00 B: 20.80 mm

110518 Starter 24 V, 4.0 kW

Replacing: 9124330

Servicing: BENFRA, Fiat, Fiat-Allis, Iveco

 B+ M10, Total length 342.00,
 Drive type Steel, Gear type DD,
 Mount. holes 3 (0)

A: 110.00 B: 27.00 mm

110519 Starter 12 V, 3.0 kW

Replacing: 9142744

Servicing: Iveco, Volvo

 B+ M10, Total length 340.50,
 Drive type Steel, Gear type DD,
 Mount. holes 3 (0)

A: 89.00 B: 48.00 mm

110521 Starter 24 V, 4.0 kW

Replacing: 9142320

Servicing: BENFRA, Fiat, Fiat-Allis, Iveco

 B+ M10, Total length 343.00,
 Drive type Steel, Gear type DD,
 Mount. holes 3 (0)

A: 110.00 B: 27.00 mm

110523 Starter 24 V, 4.8 kW

Replacing: 9174602, 9124310, 443115174602

 Servicing: ABG, Ahlmann, Case, Compair,
 Iveco, KHD, Payloader

 B+ M10, Drive type Steel, Gear type DD,
 Mount. holes 3 (0)

A: 89.00 B: 27.50 mm

110524 Starter 24 V, 4.0 kW

Replacing: 9124350

Servicing: Mercedes-Benz

 B+ M10, Total length 341.00,
 Drive type Steel, Gear type DD,
 Mount. holes 3 (0)

A: 89.00 B: 48.00 mm

110525 Starter 12 V, 3.0 kW

Replacing: 9142746, 443115144726

Servicing: Claas, Mercedes-Benz

 B+ M10, Total length 341.00,
 Drive type Steel, Gear type DD,
 Mount. holes 3 (0)

A: 89.00 B: 48.00 mm

110532 Starter 24 V, 6.6 kW

Replacing: 9125030

Servicing: Iveco

 B+ M10, B- M10, Total length 405.00,
 Drive type Steel, Gear type DD,
 Mount. holes 3 (0), Waterproof

A: 115.00 B: 21.00 mm

110534 Starter 24 V, 5.4 kW

Replacing: 9125370

 Servicing: Ford, Iveco, Various Agriculture
 Vehicles

 B+ M10, Total length 390.00,
 Drive type Steel, Gear type DD,
 Mount. holes 3 (0)

A: 89.00 B: 47.00 mm

110535 Starter 24 V, 5.4 kW

Replacing: 9125400

Servicing: Iveco

 B+ M10, B- M10, Total length 384.00,
 Drive type Steel, Gear type DD,
 Mount. holes 3 (0)

A: 89.00 B: 47.00 mm

110536 Starter 12 V, 2.7 kW

Replacing: 9142803, 9142802

 Servicing: ABG, Atlas Copco, Bobcat, Bomag,
 Bosch, Case, Claas, Deutz-Fahr, Fendt, Irmer,
 Iveco, KHD, Kramer, Mercedes-Benz

 B+ M10, Total length 234.00,
 Drive type Steel, Gear type GR,
 Mount. holes 3 (0)

A: 89.00 B: 28.00 mm

110582 Starter 24 V, 5.4 kW

Replacing: 9125480, 9125270

Servicing: Iveco

 B+ M10, B- M10, Total length 384.00,
 Drive type Steel, Gear type DD,
 Mount. holes 3 (0)

A: 92.00 B: 47.00 mm

110601 Starter 24 V, 5.4 kW

Replacing: 9125290, 9124340

Servicing: Mercedes-Benz, Steyr

 B+ M10, Total length 384.25,
 Drive type Steel, Gear type DD,
 Mount. holes 3 (0)

A: 88.85 B: 47.50 mm

110932 Starter 24 V, 5.4 kW

Replacing: 9125430

Servicing: DAF

 B+ M10, B- M10, Total length 384.50,
 Drive type Steel, Gear type DD,
 Mount. holes 3 (0), Insulated return

A: 88.85 B: 47.00 mm

110980 Starter 24 V, 5.4 kW

Replacing: 9125500

Servicing: Volvo

 B+ M10, B- M10, Total length 387.00,
 Drive type Steel, Gear type DD,
 Mount. holes 3 (0)

A: 92.00 B: 47.00 mm

112822 Starter 24 V, 4.5 kW

Replacing: 9122110

Servicing: Iveco

 B+ M10, Total length 293.00,
 Drive type Steel, Gear type GR,
 Clutch type Wet, Mount. holes 3 (0)

A: 89.00 B: 49.00 mm

111231 Starter 24 V, 6.6 kW

Replacing: 9125150

Servicing: Renault V.I.

 B+ M10, B- M10, Total length 405.00,
 Drive type Steel, Gear type DD,
 Mount. holes 3 (0), Insulated return

A: 89.00 B: 40.25 mm

113356 Starter 24 V, 3.5 kW

Replacing: 9172780, 9172702

Servicing: Belarus, GAZ, ZIL

 B+ M10, Total length 235.00,
 Drive type Steel, Gear type GR,
 Mount. holes 3 (0)

A: 99.90 B: 32.00 mm

111249 Starter 24 V, 5.4 kW

Replacing: 9125300

Servicing: Various Industrial applications

 B+ M10, Total length 381.80,
 Drive type Bronze, Gear type DD,
 Mount. holes 3 (0), Waterproof

A: 89.00 B: 48.25 mm

112119 Starter 24 V, 6.6 kW

Replacing: 9125110

Servicing: Scania

 B+ M10, B- M10, Total length 406.00,
 Drive type Steel, Gear type DD,
 Mount. holes 3 (0)

A: 92.00 B: 37.00 mm

110277 Starter 12 V, 0.8 kW

Replacing: MED04-2, MEC04-2, MEC01-2, MEC01-1, MEC01-0, MEA95-0, M3T41681, M3T38481, M3T29482, M3T29481

Servicing: Nissan

B+ M8, Total length 190.00, Drive type Steel, Gear type DD, Mount. holes 2 (0)

A: 82.35 B: 6.80 mm

110386 Starter 12 V, 1.9 kW

Replacing: MG120560

Servicing: Nissan

B+ M8, Total length 242.00, Drive type Steel, Gear type GR, Mount. holes 2 (0)

A: 82.50 B: 10.50 mm

110576 Starter 24 V, 3.2 kW

Replacing: ME017089, ME017085, ME017061, ME017056, ME017036, ME017035, ME017034, M2T67884, M2T67883, M2T67882

Servicing: Mitsubishi

B+ M8, Total length 243.00, Drive type Steel, Gear type GR, Mount. holes 2 (0)

A: 60.00 B: 19.40 mm

110999 Starter 24 V

Replacing: M7T03777, M7T03774, M007T03777, M007T03774

Servicing: Case, Caterpillar, Fiat-Allis, Peterbilt Trucks, Various, Volvo

B+ M12, B- M12, Total length 499.50, Drive type Steel, Gear type DD,

Mount. holes 3 (0), Insulated return, Oil sealed
Replacing: 42MT.

A: 92.00 B: 46.50 mm

111565 Starter 12 V, 2.2 kW

Replacing: MD191437, MD177596, MD164978, MD156987, MD121581, M2T63171, M2T62771, M2T61171, M2T60185

Servicing: Hyundai, Kia, Mitsubishi

B+ M8, Total length 239.25, Drive type Steel, Gear type GR, Clutch type Wet, Mount. holes 2 (2)

A: 77.30 B: 10.00 mm

112370 Starter 12 V, 2.2 kW

Replacing: ME204425B, ME204425, ME204424A, ME204424, ME202970, ME201650A, ME201650, M8T75074ZT, M8T75074

Servicing: Mitsubishi

B+ M8, Total length 240.50, Drive type Steel, Gear type GR, Clutch type Wet, Mount. holes 2 (2)

A: 77.00 B: 9.00 mm

112822 Starter 24 V, 4.5 kW

Replacing: M8T61671, M008T61671

Servicing: Iveco

B+ M10, Total length 293.00, Drive type Steel, Gear type GR, Clutch type Wet, Mount. holes 3 (0)

A: 89.00 B: 49.00 mm

113129 Starter 24 V, 4.5 kW

Replacing: ME077407, ME077048, ME037636, ME037465, ME037330, ME037150, M6T10673, M4T50177, M4T50171, M4T50073

Servicing: Mitsubishi

B+ M10, Total length 290.00, Drive type Steel, Gear type GR, Mount. holes 2 (1)

A: 110.00 B: 64.50 mm

113141 Starter 12 V, 0.8 kW

Replacing: M2T43881, M2T43781, M2T43681, M2T43481, M2T32581, M002T43881, M002T43781, M002T43681, M002T43481

Servicing: Mitsubishi, New Holland, Onan

B+ M8, Total length 210.00, Drive type Steel, Gear type DD, Mount. holes 2 (0)

A: 73.90 B: 29.50 mm

113194 Starter 24 V, 3.2 kW

Replacing: ME017004, ME017001, M3T52071, M2T64272, M2T64271, M002T52071, M002T64272, M002T64271

Servicing: Caterpillar, Mitsubishi

B+ M8, Total length 240.00, Drive type Steel, Gear type GR, Mount. holes 3 (0)

A: 99.90 B: 22.00 mm

113195 Starter 24 V, 3.2 kW

Replacing: ME014418, ME013008, ME012995, M8T80071B, M8T80071A, M8T80071, M008T80071B, M008T80071A, M008T80071

Servicing: Mitsubishi

B+ M8, Total length 257.00, Drive type Steel, Gear type GR, Mount. holes 2 (0)

A: 59.90 B: 14.00 mm

113210 Starter 24 V, 3.2 kW

Replacing: M2T64373, M2T64372, M2T64371, M002T64373, M002T64371

Servicing: Nissan

B+ M8, Total length 240.00, Drive type Steel, Gear type DD/GR, Mount. holes 3 (0)

A: 105.00 B: 11.00 mm



113550 Starter 12 V
 Replacing: M9T70977, M9T70379, M009T70379
 Servicing: Mack
 B+ M12, Total length 402.80,
 Drive type Steel, Gear type GR,
 Mount. holes 3 (0), Insulated return
 Replacing: 39MT.
 A: 92.00 B: 46.00 mm



113827 Starter 24 V, 7.0 kW
 Replacing: M9T82171, M009T82171
 Servicing: Cummins, Various Industrial applications
 B+ M12, B- M12, Total length 406.00,
 Drive type Steel, Gear type GR,
 Mount. holes 3 (0)
 A: 91.70 B: 46.95 mm



114001 Starter 24 V, 4.0 kW
 Replacing: M8T62671, M008T62671
 Servicing: MAN
 B+ M8, Total length 317.00,
 Drive type Steel, Gear type GR,
 Mount. holes 3 (0)
 w/ safety switch.
 A: 89.00 B: 29.00 mm



113672 Starter 24 V, 5.5 kW
 Replacing: M9T61571, M9T60471,
 M009T61571, M009T60471
 Servicing: Renault V.I.
 B+ M10, B- M10, Total length 350.00,
 Drive type Steel, Gear type GR,
 Mount. holes 3 (0)
 w/ safety switch.
 A: 91.90 B: 47.00 mm



113830 Starter 24 V, 5.5 kW
 Replacing: M9T61171, M009T61171
 Servicing: Volvo
 B+ M10, Total length 350.00,
 Drive type Steel, Gear type GR,
 Clutch type Dry, Mount. holes 3 (0)
 Over Crank Protection.
 A: 92.00 B: 47.50 mm



114003 Starter 12 V, 5.0 kW
 Replacing: M9T72271, M9T70173, M9T70172,
 M009T70173, M009T70172
 Servicing: Mercedes-Benz
 B+ M12, Total length 345.00,
 Gear type GR, Mount. holes 3 (0), Not
 Insulated return
 A: 92.00 B: 47.50 mm



113673 Starter 24 V, 5.5 kW
 Replacing: M9T60372, M9T60371,
 M009T60372, M009T60371
 Servicing: Renault V.I.
 B+ M10, B- M10, Total length 350.00,
 Drive type Steel, Gear type GR,
 Mount. holes 3 (0)
 A: 88.80 B: 39.50 mm



113851 Starter 24 V, 7.5 kW
 Replacing: M9T84771, M9T83671, M9T80473,
 M9T80472, M9T80471, M009T83671,
 M009T80473, M009T80472
 Servicing: Mercedes-Benz
 B+ M12, Total length 348.50,
 Drive type Steel, Gear type DD/GR,
 Clutch type Dry, Mount. holes 3 (0)
 Replacing: 39MT.
 A: 92.00 B: 47.70 mm



114100 Starter 24 V, 7.5 kW
 Replacing: M9T80272, M9T80071,
 M009T80271, M009T80071
 Servicing: Renault V.I.
 B+ M12, Total length 380.00,
 Gear type GR, Mount. holes 3 (0)
 A: 92.00 B: 47.00 mm



113676 Starter 24 V, 5.5 kW
 Replacing: M9T60672, M9T60671,
 M009T60672, M009T60671
 Servicing: Renault V.I.
 B+ M10, Total length 350.50,
 Drive type Steel, Gear type GR,
 Clutch type Dry, Mount. holes 3 (0)
 w/ safety switch.
 A: 89.00 B: 40.00 mm



113984 Starter 24 V, 5.0 kW
 Replacing: M9T61671, M009T61671
 Servicing: Iveco
 B+ M10, Total length 351.70, Drive type Steel,
 Gear type GR, Mount. holes 3 (0)
 A: 92.00 B: 47.80 mm



114193 Starter 24 V, 5.5 kW
 Replacing: M9T61471AM, M9T61471,
 M009T61471
 Servicing: Renault V.I., Volvo
 B+ M10, Total length 350.00,
 Gear type GR, Mount. holes 3 (0)
 A: 89.00 B: 48.00 mm



114310 Starter 24 V, 7.0 kW

Replacing: M9T82672, M9T82671, M009T82672, M009T82671

Servicing: Volvo

B+ M10, Total length 352.00,
Drive type Steel, Gear type GR,
Mount. holes 3 (0)

A: 92.00 B: 46.00 mm



114323 Starter 24 V, 5.0 kW

Replacing: M8T62471AM, M8T62471, M008T62471

Servicing: Dennis, Volvo

B+ M10, Total length 295.00,
Gear type GR, Mount. holes 3 (0)

A: 89.00 B: 26.50 mm



114334 Starter 12 V, 2.0 kW

Replacing: M2T54272, M2T54271, M002T54272, M002T54271

Servicing: Mitsubishi

B+ M8, Total length 257.50

A: 100.00 B: 60.00 mm



114343 Starter 24 V, 6.0 kW

Replacing: M4T95082, M4T95076, M4T95072, M4T95071, M004T95082, M004T95076, M004T95072, M004T95071

Servicing: Mitsubishi

B+ M10, Total length 324.60

A: 100.00 B: 77.00 mm



114418 Starter 12 V, 3.6 kW

Replacing: ME215097, ME015766, M8T55073, M8T55071, M008T55073, M008T55071

Servicing: Mitsubishi

B+ M8, Total length 287.60,
Gear type GR, Mount. holes 2 (0)

A: 60.00 B: 18.00 mm



114445 Starter 24 V, 5.0 kW

Replacing: M8T60873, M8T60872, M8T60871, M008T60873, M008T60872, M008T60871, 32B66-12100, 32B66-02102

Servicing: Caterpillar

B+ M8, Total length 288.00,
Drive type Steel, Gear type GR,
Mount. holes 2 (0)

A: 82.50 B: 22.50 mm



114474 Starter 24 V, 5.0 kW

Replacing: M8T60972, M8T60971, M008T60972

Servicing: Isuzu

B+ M10, Total length 287.00,
Gear type GR, Mount. holes 2 (0)

A: 95.00 B: 45.00 mm



114733 Starter 24 V, 5.5 kW

Replacing: M9T62671

Servicing: Renault V.I., Volvo

B+ M10, Total length 318.00,
Gear type GR, Mount. holes 3 (0)

A: 89.00 B: 27.00 mm



114872 Starter 24 V, 5.5 kW

Replacing: M9T64171ZT, M9T64171, M9T62173, M9T62172, M009T64171ZT, M009T64171, M009T62173, M009T62172

Servicing: Renault V.I., Volvo

B+ M10, Total length 351.00,
Gear type GR, Mount. holes 3 (0)

A: 92.00 B: 46.00 mm



NEW PRODUCT
www.hc-cargo.com

114873 Starter 24 V, 5.5 kW

Replacing: M9T62871, M009T62871

Servicing: Volvo BM

B+ M10, Gear type GR,
Mount. holes 3 (0)

A: 89.00 B: 28.00 mm



NEW PRODUCT
www.hc-cargo.com

115439* Starter 24 V, 7.0 kW

Replacing: M9T83771

Servicing: Scania

Gear type GR, Mount. holes 3 (0)



NEW PRODUCT
www.hc-cargo.com

115440* Starter 24 V, 7.0 kW

Replacing: M9T83071, M009T83071

Servicing: MAN

Gear type GR, Mount. holes 3 (0)

NEW PRODUCT
www.hc-cargo.com
115451* Starter 24 V, 5.5 kW

Replacing: M9T66471, M9T64071

Servicing: Volvo

NEW PRODUCT
www.hc-cargo.com
115518* Starter 24 V, 5.5 kW

Replacing: M9T66371, M009T66371

Servicing: Volvo

Gear type GR, Mount. holes 3 (0)

115556 Starter 24 V, 5.5 kW

Replacing: M9T61971, M009T61971

Servicing: MAN

Gear type GR, Mount. holes 3 (0)

NEW PRODUCT
www.hc-cargo.com
115593* Starter 24 V, 5.5 kW

 Replacing: M9T61474, M9T61473,
M009T64972, M009T64971, M009T61474,
M009T61473

Servicing: Volvo

Gear type GR, Mount. holes 3 (0)

NEW PRODUCT
www.hc-cargo.com
115731* Starter 24 V, 5.0 kW

Replacing: M8T62771, M008T62771

Gear type GR, Mount. holes 3 (0)

111393# Starter 24 V, 3.5 kW

 Replacing: 0-21000-4935, 0-21000-4934,
0-21000-4930, 0-21000-3470, 0-21000-3433,
0-21000-2340

Servicing: Isuzu

 B+ M8, Total length 312.75,
Drive type Steel, Gear type DD,
Clutch type Wet, Mount. holes 2 (0)
w/ safety switch.

A: 95.00 B: 19.00 mm

111982 Starter 24 V, 4.0 kW

 Replacing: 0-23000-2590, 0-23000-2358,
0-23000-2350

Servicing: Mercedes-Benz

 B+ M10, Total length 342.00,
Drive type Steel, Gear type GR,
Mount. holes 3 (0)

A: 88.75 B: 45.00 mm

112253 Starter 12 V, 2.5 kW

 Replacing: 0-24000-3200, 0-23000-2480,
0-23000-2444, 0-23000-2440, 0-23000-2380,
0-23000-2234, 0-23000-2230

Servicing: Ford, Ingersoll Rand

 B+ M10, Total length 342.00,
Drive type Steel, Gear type GR,
Clutch type Dry, Mount. holes 3 (0)
Replacing: 28MT.

A: 88.80 B: 45.00 mm

113435 Starter 24 V, 4.5 kW

Replacing: 0-23000-1940

Servicing: Hummer, Various

 B+ M10, Total length 336.50,
Drive type Steel, Gear type GR,
Clutch type Dry, Mount. holes 2 (0)
Replacing: 28MT.

A: 82.00 B: 7.50 mm

114442 Starter 24 V, 6.0 kW

 Replacing: 0-23000-6072, 0-23000-6071,
0-23000-6070

Servicing: Isuzu

 B+ M10, Total length 324.50,
Drive type Steel, Mount. holes 3 (0)

A: 105.00 B: 28.50 mm

114474 Starter 24 V, 5.0 kW

Replacing: 0-24000-3041, 0-24000-3040

Servicing: Isuzu

 B+ M10, Total length 287.00,
Gear type GR, Mount. holes 2 (0)

A: 95.00 B: 45.00 mm



110525 Starter 12 V, 3.0 kW

Replacing: 35259380

Servicing: Claas, Mercedes-Benz

B+ M10, Total length 341.00,

Drive type Steel, Gear type DD,

Mount. holes 3 (0)

A: 89.00 B: 48.00 mm

110518 Starter 24 V, 4.0 kW

Replacing: 858320

Servicing: BENFRA, Fiat, Fiat-Allis, Iveco

B+ M10, Total length 342.00, Drive type Steel, Gear type DD, Mount. holes 3 (0)

A: 110.00 B: 27.00 mm

110999 Starter 24 V

Replacing: MFY6601K, MFY6601I, MFY6401L, MFY6401K, MFY6201K, MFY6201I

Servicing: Case, Caterpillar, Fiat-Allis, Peterbilt Trucks, Various, Volvo

B+ M12, B- M12, Total length 499.50, Drive type Steel, Gear type DD, Mount. holes 3 (0), Insulated return, Oil sealed

Replacing: 42MT.

A: 92.00 B: 46.50 mm

111231 Starter 24 V, 6.6 kW

Replacing: 860507

Servicing: Renault V.I.

B+ M10, B- M10, Total length 405.00, Drive type Steel, Gear type DD, Mount. holes 3 (0), Insulated return

A: 89.00 B: 40.25 mm

111771 Starter 24 V, 6.2 kW

Replacing: 860705

Servicing: Mercedes-Benz

B+ M12, Total length 405.00, Drive type Steel, Gear type DD, Mount. holes 3 (0)

A: 92.00 B: 47.00 mm

111910 Starter 24 V, 6.7 kW

Replacing: 860305Z

Servicing: Scania

B+ M12, 30h M12, Total length 429.00, Drive type Steel, Gear type DD, Clutch type Dry, Mount. holes 3 (0), Not Insulated return

A: 92.00 B: 47.00 mm

112055 Starter 24 V, 5.2 kW

Manufacturer: Bosch

Replacing: 861035

Servicing: DAF

B+ M10, Total length 340.00, Drive type Steel, Gear type DD, Mount. holes 3 (0)

A: 110.00 B: 48.00 mm

112224 Starter 24 V, 6.7 kW

Replacing: 860650

Servicing: Scania

B+ M12, Total length 428.00, Drive type Steel, Gear type DD, Clutch type Dry, Mount. holes 3 (0)

A: 92.00 B: 48.00 mm

112656[#] Starter 24 V, 4.5 kW

Replacing: 860803

Servicing: DAF, ERF, Foden, Seddon

B+ M10, Total length 375.00, Drive type Steel, Gear type DD, Mount. holes 3 (0)

A: 89.00 B: 48.00 mm

113333[#] Starter 24 V, 7.0 kW

Replacing: MS1-410A

Servicing: Seddon

B+ M12, B- M12, Total length 483.00, Drive type Steel, Gear type DD, Mount. holes 3 (0), Insulated return

A: 92.00 B: 47.00 mm

113827 Starter 24 V, 7.0 kW

Replacing: M105R3507SE

Servicing: Cummins, Various Industrial applications

B+ M12, B- M12, Total length 406.00, Drive type Steel, Gear type GR, Mount. holes 3 (0)

A: 91.70 B: 46.95 mm



110205 Starter 24 V, 6.5 kW
 Replacing: 19024075
 Servicing: Volvo
 B+ M10, Total length 407.00,
 Drive type Steel, Gear type DD,
 Mount. holes 3 (0), Waterproof
 A: 89.00 B: 47.50 mm



110206 Starter 24 V, 5.4 kW
 Replacing: 35032VL, 19024109, 19024025,
 19024010
 Servicing: Claas, Fiat-Allis, Kässbohrer, MAN,
 Mercedes-Benz, Neoplan, Setra
 B+ M12, B- M10, Total length 390.00,
 Drive type Steel, Gear type DD,
 Mount. holes 3 (0)
 A: 92.00 B: 47.50 mm



110207 Starter 24 V, 5.4 kW
 Replacing: 19024553, 19024013
 Servicing: Volvo, Volvo BM
 B+ M10, B- M10, Total length 387.00,
 Drive type Steel, Gear type DD,
 Mount. holes 3 (0)
 A: 89.00 B: 47.00 mm



110208 Starter 24 V, 5.4 kW
 Replacing: 19024576, 19024555, 19024099,
 19024037, 19024016, 19024015
 Servicing: Fiat-Allis, Mercedes-Benz, Steyr, Volvo
 B+ M10, B- M10, Total length 387.00,
 Drive type Steel, Gear type DD,
 Mount. holes 3 (0), Oil sealed, Waterproof
 A: 89.00 B: 48.50 mm



110210 Starter 24 V, 6.6 kW
 Replacing: 19024051
 Servicing: Fiat-Allis, Kässbohrer, MAN,
 Mercedes-Benz, Mitsubishi, Neoplan,
 Ssangyong
 B+ M12, B- M10, Total length 407.00,
 Drive type Steel, Gear type DD,
 Mount. holes 3 (0)
 A: 92.00 B: 48.50 mm

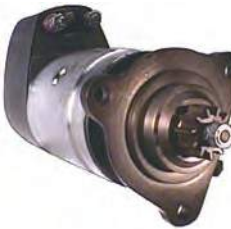

110212 Starter 24 V, 6.6 kW
 Replacing: 19024078, 19024042
 Servicing: Iveco, Scania
 B+ M10, B- M10, Total length 407.00,
 Drive type Steel, Gear type DD,
 Mount. holes 3 (0)
 A: 92.00 B: 47.65 mm



110213 Starter 24 V, 6.6 kW
 Replacing: 19024053
 Servicing: Fiat, Iveco
 B+ M12, B- M10, Total length 407.00,
 Drive type Steel, Gear type DD,
 Mount. holes 3 (0)
 A: 115.00 B: 20.80 mm



110214 Starter 24 V, 6.6 kW
 Replacing: 19024077
 Servicing: Scania
 B+ M10, B- M10, Total length 407.00,
 Drive type Steel, Gear type DD,
 Mount. holes 3 (0), Insulated return
 A: 92.00 B: 37.00 mm



110368 Starter 12 V, 2.3 kW
 Replacing: 19024249, 19024239
 Servicing: Audi, Mercedes-Benz, Volvo
 B+ M10, Total length 289.00,
 Drive type Steel, Gear type DD,
 Mount. holes 2 (2)
 A: 82.50 B: 21.00 mm



110409 Starter 12 V, 3.0 kW
 Replacing: 19024563, 19024001
 Servicing: Kaelble, Mack, Sennebogen
 B+ M10, Total length 384.00, Drive type Steel,
 Gear type DD, Mount. holes 3 (0)
 A: 89.00 B: 47.00 mm



110436 Starter 12 V
 Replacing: 323-855, 323-830, 323-829,
 1993983, 1993961, 1993943, 1993942,
 1993939, 1993938, 1993937, 1993935
 Servicing: Caterpillar, Clark, Mack, Various
 B+ 1/2" UNC, Total length 506.00,
 Drive type Steel, Gear type DD,
 Mount. holes 3 (0), Insulated return, Oil
 sealed
 Replacing: 42MT.
 A: 92.00 B: 46.00 mm



110517 Starter 24 V, 3.2 kW
 Replacing: 19024242
 Servicing: BENFRA, Fiat-Allis, Iveco
 B+ M10, Total length 295.00, Drive type Steel,
 Gear type DD, Mount. holes 3 (0)
 A: 110.00 B: 27.00 mm



110518 Starter 24 V, 4.0 kW
 Replacing: 19024256, 19024232
 Servicing: BENFRA, Fiat, Fiat-Allis, Iveco
 B+ M10, Total length 342.00,
 Drive type Steel, Gear type DD,
 Mount. holes 3 (0)
 A: 110.00 B: 27.00 mm



110519 Starter 12 V, 3.0 kW
 Replacing: 19024229
 Servicing: Iveco, Volvo
 B+ M10, Total length 340.50,
 Drive type Steel, Gear type DD,
 Mount. holes 3 (0)
 A: 89.00 B: 48.00 mm



110521 Starter 24 V, 4.0 kW
 Replacing: 19024273, 19024231
 Servicing: BENFRA, Fiat, Fiat-Allis, Iveco
 B+ M10, Total length 343.00,
 Drive type Steel, Gear type DD,
 Mount. holes 3 (0)
 A: 110.00 B: 27.00 mm



110523 Starter 24 V, 4.8 kW
 Replacing: 19024813, 19024234, 19024226
 Servicing: ABG, Ahlmann, Case, Compair,
 Iveco, KHD, Payloader
 B+ M10, Drive type Steel, Gear type DD,
 Mount. holes 3 (0)
 A: 89.00 B: 27.50 mm



110524 Starter 24 V, 4.0 kW
 Replacing: DRX67131, 19024258, 19024236,
 19024225, 19024204, 10479627
 Servicing: Mercedes-Benz
 B+ M10, Total length 341.00,
 Drive type Steel, Gear type DD,
 Mount. holes 3 (0)
 A: 89.00 B: 48.00 mm



110525 Starter 12 V, 3.0 kW
 Replacing: 19024223, 19024205
 Servicing: Claas, Mercedes-Benz
 B+ M10, Total length 341.00,
 Drive type Steel, Gear type DD,
 Mount. holes 3 (0)
 A: 89.00 B: 48.00 mm



110527 Starter 24 V, 4.0 kW
 Replacing: 19024233
 Servicing: Scania, Steyr
 B+ M10, Total length 342.00,
 Drive type Steel, Gear type DD,
 Mount. holes 3 (0)
 A: 89.00 B: 46.50 mm



110531 Starter 24 V, 6.6 kW
 Replacing: 19024071
 Servicing: Fiat-Allis, Gmeinder, KHD,
 Mercedes-Benz
 B+ M12, B- M10, Total length 405.00,
 Drive type Steel, Gear type DD
 A: 56.00 B: 37.00 mm



110532 Starter 24 V, 6.6 kW
 Replacing: 19024054
 Servicing: Iveco
 B+ M10, B- M10, Total length 405.00,
 Drive type Steel, Gear type DD,
 Mount. holes 3 (0), Waterproof
 A: 115.00 B: 21.00 mm



110533 Starter 24 V, 5.4 kW
 Replacing: 19024011
 Servicing: Steyr
 B+ M10, B- M10, Total length 387.00,
 Drive type Steel, Gear type DD,
 Mount. holes 3 (0)
 A: 89.00 B: 46.50 mm



110534 Starter 24 V, 5.4 kW
 Replacing: 19024030
 Servicing: Ford, Iveco, Various Agriculture
 Vehicles
 B+ M10, Total length 390.00,
 Drive type Steel, Gear type DD,
 Mount. holes 3 (0)
 A: 89.00 B: 47.00 mm



110535 Starter 24 V, 5.4 kW
 Replacing: 19024035
 Servicing: Iveco
 B+ M10, B- M10, Total length 384.00,
 Drive type Steel, Gear type DD,
 Mount. holes 3 (0)
 A: 89.00 B: 47.00 mm

110536 Starter 12 V, 2.7 kW

Replacing: 19024824, 19024252, 19024235, 19024224

Servicing: ABG, Atlas Copco, Bobcat, Bomag, Bosch, Case, Claas, Deutz-Fahr, Fendt, Irmer, Iveco, KHD, Kramer, Mercedes-Benz

B+ M10, Total length 234.00, Drive type Steel, Gear type GR, Mount. holes 3 (0)

A: 89.00 B: 28.00 mm

110582 Starter 24 V, 5.4 kW

Replacing: 19024046, 19024018

Servicing: Iveco

B+ M10, B- M10, Total length 384.00, Drive type Steel, Gear type DD, Mount. holes 3 (0)

A: 92.00 B: 47.00 mm

110601 Starter 24 V, 5.4 kW

Replacing: 19024578

Servicing: Mercedes-Benz, Steyr

B+ M10, Total length 384.25, Drive type Steel, Gear type DD, Mount. holes 3 (0)

A: 88.85 B: 47.50 mm

110932 Starter 24 V, 5.4 kW

Replacing: 19024040

Servicing: DAF

B+ M10, B- M10, Total length 384.50, Drive type Steel, Gear type DD, Mount. holes 3 (0), Insulated return

A: 88.85 B: 47.00 mm

110980 Starter 24 V, 5.4 kW

Replacing: 19024048

Servicing: Volvo

B+ M10, B- M10, Total length 387.00, Drive type Steel, Gear type DD, Mount. holes 3 (0)

A: 92.00 B: 47.00 mm

110981 Starter 24 V, 5.4 kW

Replacing: 19024106, 19024049

Servicing: DAF

B+ M12, B- M10, Total length 387.00, Drive type Steel, Gear type DD, Mount. holes 3 (0)

A: 110.00 B: 47.50 mm

110999 Starter 24 V

Replacing: 1993945, 1993833, 1993815, 1993814, 1993808, 1993804, 1993797, 1993796, 1993704, 1990809, 1990497

Servicing: Case, Caterpillar, Fiat-Allis, Peterbilt Trucks, Various, Volvo

B+ M12, B- M12, Total length 499.50, Drive type Steel, Gear type DD, Mount. holes 3 (0), Insulated return, Oil sealed

Replacing: 42MT.

A: 92.00 B: 46.50 mm

111003 Starter 24 V, 5.4 kW

Replacing: 19024012

Servicing: Hanomag, Mercedes-Benz

B+ M10, Total length 387.50, Drive type Steel, Gear type DD, Mount. holes 3 (0), Waterproof

A: 89.00 B: 47.50 mm

111046 Starter 24 V, 6.6 kW

Replacing: 19024052

Servicing: MAN, Volvo

B+ M10, Total length 404.00, Drive type Steel, Gear type DD, Mount. holes 3 (0)

A: 88.85 B: 48.00 mm

111217 Starter 12 V, 3.0 kW

Replacing: 19024566, 19024565

Servicing: Volvo, Volvo BM

B+ M10, B- M10, Total length 386.50, Drive type Steel, Gear type DD, Mount. holes 3 (0)

A: 89.00 B: 48.00 mm

111231 Starter 24 V, 6.6 kW

Replacing: 19024080

Servicing: Renault V.I.

B+ M10, B- M10, Total length 405.00, Drive type Steel, Gear type DD, Mount. holes 3 (0), Insulated return

A: 89.00 B: 40.25 mm

111249 Starter 24 V, 5.4 kW

Replacing: 19024554, 19024027

Servicing: Various Industrial applications

B+ M10, Total length 381.80, Drive type Bronze, Gear type DD, Mount. holes 3 (0), Waterproof

A: 89.00 B: 48.25 mm



111399 Starter 24 V, 4.0 kW
 Replacing: 19024262
 Servicing: DAF
 B+ M10, B- M8, Total length 352.50,
 Drive type Steel, Gear type DD,
 Clutch type Dry, Mount. holes 3 (0)
 A: 89.00 B: 38.00 mm



111640 Starter 24 V, 4.0 kW
 Replacing: 19024264
 Servicing: MAN
 B+ M10, Total length 338.50,
 Drive type Steel, Gear type DD,
 Mount. holes 3 (0)
 A: 88.50 B: 28.00 mm



111709 Starter 12 V, 2.2 kW
 Replacing: 110002
 Servicing: Daewoo, Isuzu, TCM
 B+ M8, Total length 233.65,
 Drive type Steel, Gear type GR,
 Clutch type Wet, Mount. holes 2 (0)
 A: 95.00 B: 20.00 mm



111771 Starter 24 V, 6.2 kW
 Replacing: 19024179
 Servicing: Mercedes-Benz
 B+ M12, Total length 405.00,
 Drive type Steel, Gear type DD,
 Mount. holes 3 (0)
 A: 92.00 B: 47.00 mm



111793 Starter 12 V, 3.0 kW
 Replacing: 19024261
 Servicing: Caterpillar, Mercedes-Benz, Volvo
 B+ M10, Total length 342.00,
 Drive type Steel, Gear type DD,
 Clutch type Dry, Mount. holes 3 (0)
 A: 88.80 B: 28.50 mm



111805 Starter 12 V, 2.5 kW
 Replacing: 17610-Q1010, 111534
 Servicing: Ford, Nissan
 B+ M8, Total length 228.00, Drive type Steel,
 Gear type GR, Mount. holes 2 (0)
 A: 95.00 B: 11.50 mm



111982 Starter 24 V, 4.0 kW
 Replacing: DRX67149, DRX67095, 8200138,
 8200004, 19070039, 10479626, 10461470
 Servicing: Mercedes-Benz
 B+ M10, Total length 342.00, Drive type Steel,
 Gear type GR, Mount. holes 3 (0)
 A: 88.75 B: 45.00 mm



112089 Starter 12 V
 Replacing: 323-871, 1993977, 1993856,
 1993816, 1993813, 1993807, 1993803,
 1990495, 1990490, 1990483, 1990478
 Servicing: Case, Caterpillar, Cummins, Ford,
 Freightliner, International, Kenworth, Mack,
 New Holland, Perkins, Volvo
 B+ M12, B- M12, 15a M5,
 Total length 500.00, Drive type Steel,
 Gear type DD, Clutch type Wet,
 Mount. holes 3 (0), Insulated return,
 Oil sealed
 Replacing: 42MT.
 A: 92.00 B: 46.00 mm



112116 Starter 24 V, 6.6 kW
 Replacing: 19024085
 Servicing: Volvo
 B+ M12, B- M12, Total length 407.00,
 Drive type Steel, Gear type DD,
 Mount. holes 3 (0), Insulated return
 A: 92.00 B: 47.00 mm



112119 Starter 24 V, 6.6 kW
 Replacing: 19024076
 Servicing: Scania
 B+ M10, B- M10, Total length 406.00,
 Drive type Steel, Gear type DD,
 Mount. holes 3 (0)
 A: 92.00 B: 37.00 mm



112120 Starter 24 V, 6.6 kW
 Replacing: 19024072
 Servicing: MAN, Mercedes-Benz
 B+ M12, B- M10, Total length 405.00,
 Drive type Steel, Gear type DD,
 Mount. holes 3 (0), Insulated return
 A: 92.00 B: 47.50 mm



112224 Starter 24 V, 6.7 kW
 Replacing: 19070036
 Servicing: Scania
 B+ M12, Total length 428.00,
 Drive type Steel, Gear type DD,
 Clutch type Dry, Mount. holes 3 (0)
 A: 92.00 B: 48.00 mm



112227# Starter 24 V, 8.0 kW
 Replacing: 19024186
 Servicing: Renault V.I.
 B+ M10, 15a M5, Total length 405.00,
 Drive type Steel, Gear type DD,
 Mount. holes 3 (0)
 A: 92.00 B: 47.00 mm



112253 Starter 12 V, 2.5 kW
 Replacing: 10479641, 10479638, 10479625,
 10479618, 10479615, 10465314, 10465151
 Servicing: Ford, Ingersoll Rand
 B+ M10, Total length 342.00,
 Drive type Steel, Gear type GR,
 Clutch type Dry, Mount. holes 3 (0)
 Replacing: 28MT.
 A: 88.80 B: 45.00 mm



112258# Starter 12 V
 Replacing: 1993785, 1990438, 1990377,
 1114944, 1114936, 1114934, 1114927,
 1114920, 1114904, 1114796, 1114789
 Servicing: Chevrolet, Detroit, GMC
 B+ 1/2" UNC, Total length 519.00,
 Drive type Steel, Gear type DD,
 Clutch type Dry, Mount. holes 3 (0),
 Oil sealed
 Replacing: 42MT.
 A: 92.00 B: 47.50 mm



112365 Starter 12 V, 2.2 kW
 Replacing: DSR1167L, 110566
 Servicing: Nissan
 B+ M8, Total length 224.00,
 Drive type Steel, Gear type GR,
 Clutch type Wet, Mount. holes 2 (0)
 A: 95.00 B: 10.50 mm



112534 Starter 12 V, 2.0 kW
 Replacing: 8000286
 Servicing: JCB, KHD, Perkins
 B+ M8, Total length 239.00, Drive type Steel,
 Gear type GR, Mount. holes 2 (0)
 A: 74.00 B: 18.00 mm



112581 Starter 24 V, 6.2 kW
 Replacing: 19070032
 Servicing: DAF
 B+ M12, Total length 380.00, Drive type Steel,
 Gear type DD, Mount. holes 3 (0)
 A: 110.00 B: 48.00 mm



113125 Starter 12 V
 Replacing: 323-840, 1993854, 1993767,
 1990347, 10461011, 10461006
 Servicing: Ford, New Holland
 B+ 1/2" UNC, Total length 401.50,
 Drive type Steel, Gear type DD,
 Clutch type Wet, Mount. holes 3 (0),
 Oil sealed
 Replacing: 37MT, 41MT.
 A: 92.00 B: 48.25 mm



113126 Starter 12 V
 Replacing: 323-879, 1993963, 10478806,
 10461081
 Servicing: Caterpillar, Chevrolet, Ford, GMC,
 Kenworth
 B+ 1/2" UNC, Total length 434.00,
 Drive type Steel, Gear type DD,
 Clutch type Dry, Mount. holes 3 (0),
 Oil sealed
 Replacing: 37MT, 41MT.
 A: 88.90 B: 46.50 mm



113131# Starter 12 V, 3.0 kW
 Replacing: 94052175, 94039465
 Servicing: Isuzu
 B+ M10, Total length 319.50, Drive type Steel,
 Gear type GR, Mount. holes 3 (0)
 A: 105.00 B: 40.50 mm



113153 Starter 12 V
 Replacing: 323-864, 1993836, 1993776,
 1990484, 1990428, 1990426, 1990421,
 1990393, 1990391, 1990355, 10479082
 Servicing: Freightliner
 B+ 1/2" UNC, Drive type Steel,
 Gear type DD, Mount. holes 3 (0)
 Replacing: 42MT.
 A: 91.85 B: 45.25 mm



113435 Starter 24 V, 4.5 kW
 Replacing: 323-408, 1113591, 10479611,
 10465015, 10461453
 Servicing: Hummer, Various
 B+ M10, Total length 336.50,
 Drive type Steel, Gear type GR,
 Clutch type Dry, Mount. holes 2 (0)
 Replacing: 28MT.
 A: 82.00 B: 7.50 mm



113466 Starter 24 V, 4.0 kW
 Replacing: 19024280
 Servicing: Renault V.I.
 B+ M10, Total length 316.00,
 Drive type Steel, Gear type DD/GR,
 Clutch type Dry, Mount. holes 3 (0)
 A: 88.90 B: 22.00 mm

113468 Starter 24 V, 4.0 kW

Replacing: 19024286

Servicing: MAN

 B+ M10, Total length 340.00,
 Drive type Steel, Gear type DD,
 Clutch type Dry, Mount. holes 3 (0)
Bosch GR HC-CARGO 112446.

A: 89.00 B: 27.00 mm

113550 Starter 12 V

 Replacing: 8300019, 8200040, 8200033,
 19011530, 19011521, 19011518, 19011516,
 19011506, 10461777, 10461753

Servicing: Mack

 B+ M12, Total length 402.80,
 Drive type Steel, Gear type GR,
 Mount. holes 3 (0), Insulated return
Replacing: 39MT.

A: 92.00 B: 46.00 mm

113608 Starter 24 V, 6.2 kW

Replacing: 19070033

Servicing: Evobus, Kässbohrer, Mercedes-Benz

 B+ M12, 15a M6, Total length 380.50,
 Drive type Steel, Gear type DD/GR,
 Clutch type Wet, Mount. holes 3 (0)

A: 92.00 B: 46.25 mm

113827 Starter 24 V, 7.0 kW

 Replacing: 8300025, 8200072, 8200000,
 19026030, 19026026, 19023060

 Servicing: Cummins, Various Industrial
 applications

 B+ M12, B- M12, Total length 406.00,
 Drive type Steel, Gear type GR,
 Mount. holes 3 (0)

A: 91.70 B: 46.95 mm

113851 Starter 24 V, 7.5 kW

Replacing: 8200519, 19024196, 19011501

Servicing: Mercedes-Benz

 B+ M12, Total length 348.50,
 Drive type Steel, Gear type DD/GR,
 Clutch type Dry, Mount. holes 3 (0)
Replacing: 39MT.

A: 92.00 B: 47.70 mm

NEW PRODUCT
www.hc-cargo.com

114003 Starter 12 V, 5.0 kW

Replacing: 19011504

Servicing: Mercedes-Benz

 B+ M12, Total length 345.00,
 Gear type GR, Mount. holes 3 (0), Not
 Insulated return

A: 92.00 B: 47.50 mm

114416 Starter 24 V, 7.5 kW

 Replacing: 1993828, 1993788, 10479142,
 10479130, 10479067, 10461362, 10461141,
 10461080

Servicing: Mack

 B+ M12, Total length 496.00,
 Drive type Steel, Mount. holes 3 (0)

A: 92.00 B: 47.50 mm

NEW PRODUCT
www.hc-cargo.com

115447* Starter 24 V

Replacing: 8200435

Gear type GR, Mount. holes 3 (0)

Replacing: 39mt.



110640 Starter 12 V, 3.0 kW

Replacing: DM2134, DM2130, DM2120, 2130

Servicing: Allis Chalmers, Fiat, Fiat-Allis, Long

B+ M10, Total length 310.00,

Drive type Steel, Gear type DD,

Mount. holes 3 (0)

A: 110.00 B: 26.00 mm

110616 Starter 24 V, 4.5 kW

Replacing: 0350-502-0131, 0350-502-0130

Servicing: Nissan

 B+ M8, Total length 292.00,
 Drive type Steel, Gear type GR,
 Mount. holes 3 (0)

A: 105.00 B: 33.80 mm

114017 Starter 24 V, 5.5 kW

 Replacing: 0350-552-0338, 0350-552-0330,
 0350-552-0311

Servicing: Hino

 B+ M10, Total length 326.00,
 Drive type Steel, Gear type GR,
 Mount. holes 3 (0)

A: 100.00 B: 25.00 mm

114337 Starter 12 V, 4.5 kW

 Replacing: 0350-552-0061, 0350-552-0014,
 0330-402-0320, 0330-402-0311, 0330-402-
 0310, 0330-402-0012

Servicing: Hino

B+ M10, Total length 296.60

A: 100.00 B: 64.00 mm

114344 Starter 24 V, 6.0 kW

Replacing: 0350-602-0118

Servicing: Hino

B+ M10, Total length 324.45

A: 121.00 B: 58.00 mm

114345 Starter 24 V, 6.0 kW

 Replacing: 0350-702-0339, 0350-702-0294,
 0350-702-0226, 0350-702-0180, 0350-702-
 0025, 0350-702-0024

Servicing: Hino

 B+ M10, Total length 325.00,
 Drive type Steel, Mount. holes 3 (0)

A: 122.00 B: 43.00 mm

114421 Starter 24 V, 6.0 kW

Replacing: 0350-602-0261

Servicing: Hino

 B+ M10, Total length 324.50,
 Mount. holes 3 (0)

A: 105.00 B: 38.50 mm

114436 Starter 24 V, 5.0 kW

 Replacing: 0355-502-0041, 0355-502-0040,
 0355-502-0019

Servicing: Hino

 B+ M8, Total length 287.90,
 Drive type Steel, Mount. holes 2 (0)

A: 105.00 B: 29.50 mm

114441 Starter 24 V, 5.5 kW

Replacing: 0350-552-0357

Servicing: Hino

 B+ M10, Total length 321.00,
 Drive type Steel, Mount. holes 2 (0)

A: 105.00 B: 31.00 mm



110999 Starter 24 V

Replacing: 9G4338

Servicing: Case, Caterpillar, Fiat-Allis, Peterbilt Trucks, Various, Volvo

B+ M12, B- M12, Total length 499.50,

Drive type Steel, Gear type DD,

Mount. holes 3 (0), Insulated return,

Oil sealed

Replacing: 42MT.

A: 92.00 B: 46.50 mm

110205 Starter 24 V, 6.5 kW

Replacing: D13E101TE, D13E101

Servicing: Volvo

 B+ M10, Total length 407.00,
 Drive type Steel, Gear type DD,
 Mount. holes 3 (0), Waterproof

A: 89.00 B: 47.50 mm

110368 Starter 12 V, 2.3 kW

Replacing: D9R141

Servicing: Audi, Mercedes-Benz, Volvo

 B+ M10, Total length 289.00,
 Drive type Steel, Gear type DD,
 Mount. holes 2 (2)

A: 82.50 B: 21.00 mm

110576 Starter 24 V, 3.2 kW

 Replacing: TM000A06001, MG232415,
 M04501, M000A026

Servicing: Mitsubishi

 B+ M8, Total length 243.00,
 Drive type Steel, Gear type GR,
 Mount. holes 2 (0)

A: 60.00 B: 19.40 mm

111047 Starter 12 V, 3.1 kW

 Replacing: D9R144, D9R116, D11E167T,
 D11E167

Servicing: Volvo, Volvo Penta

 B+ M8, Total length 302.75,
 Drive type Steel, Gear type GR,
 Mount. holes 3 (0), Insulated return

A: 88.85 B: 47.70 mm

111231 Starter 24 V, 6.6 kW

 Replacing: D13HP703, D13E123TE, D13E123T,
 D13E1231TE, D13E123, D13E121TE,
 D13E119TE, D13E118TE, D13E118

Servicing: Renault V.I.

 B+ M10, B- M10, Total length 405.00,
 Drive type Steel, Gear type DD,
 Mount. holes 3 (0), Insulated return

A: 89.00 B: 40.25 mm

111565 Starter 12 V, 2.2 kW

Replacing: TM000A18601, MG122202, HQ808670

Servicing: Hyundai, Kia, Mitsubishi

 B+ M8, Total length 239.25,
 Drive type Steel, Gear type GR,
 Clutch type Wet, Mount. holes 2 (2)

A: 77.30 B: 10.00 mm

111851 Starter 12 V, 2.0 kW

 Replacing: TM000A15701, D7R46, D7R43,
 D7R28, D7R19

Servicing: Mercedes-Benz

 B+ M8, Total length 240.00, Drive type Steel,
 Gear type GR, Mount. holes 2 (2)

A: 82.50 B: 25.50 mm

112224 Starter 24 V, 6.7 kW

Replacing: D13HP601

Servicing: Scania

 B+ M12, Total length 428.00,
 Drive type Steel, Gear type DD,
 Clutch type Dry, Mount. holes 3 (0)

A: 92.00 B: 48.00 mm

112227# Starter 24 V, 8.0 kW

Replacing: D13HP709, D13HP613

Servicing: Renault V.I.

 B+ M10, 15a M5, Total length 405.00,
 Drive type Steel, Gear type DD,
 Mount. holes 3 (0)

A: 92.00 B: 47.00 mm

112651 Starter 24 V, 4.8 kW

Replacing: D11E149, 94955E

Servicing: Bosch, KHD

 B+ M10, Total length 351.50,
 Drive type Steel, Gear type DD,
 Mount. holes 3 (0)

A: 89.00 B: 48.00 mm

113129 Starter 24 V, 4.5 kW

 Replacing: TM000A08701, MG250302,
 M24798, M24698, M000A0291

Servicing: Mitsubishi

 B+ M10, Total length 290.00,
 Drive type Steel, Gear type GR,
 Mount. holes 2 (1)

A: 110.00 B: 64.50 mm

113141 Starter 12 V, 0.8 kW

Replacing: TM000A21901

Servicing: Mitsubishi, New Holland, Onan

 B+ M8, Total length 210.00,
 Drive type Steel, Gear type DD,
 Mount. holes 2 (0)

A: 73.90 B: 29.50 mm

113465 Starter 12 V, 3.0 kW

 Replacing: D11E119T, D11E119, D11E104
 Servicing: Renault V.I.

 B+ M10, Total length 338.00,
 Drive type Steel, Gear type DD,
 Clutch type Dry, Mount. holes 3 (0)
 A: 88.75 B: 21.50 mm

113466 Starter 24 V, 4.0 kW

 Replacing: D11E99, D11E122T, D11E122,
 76517, 076517

Servicing: Renault V.I.

 B+ M10, Total length 316.00,
 Drive type Steel, Gear type DD/GR,
 Clutch type Dry, Mount. holes 3 (0)
 A: 88.90 B: 22.00 mm

113676 Starter 24 V, 5.5 kW

Replacing: MF250671

Servicing: Renault V.I.

 B+ M10, Total length 350.50,
 Drive type Steel, Gear type GR,
 Clutch type Dry, Mount. holes 3 (0)
w/ safety switch.

A: 89.00 B: 40.00 mm

113934 Starter 24 V, 5.5 kW

Replacing: S635329A, FS60PR019

Servicing: Bova, DAF, Solaris

 B+ M10, Total length 321.00,
 Drive type Steel, Gear type GR,
 Mount. holes 3 (0)

A: 110.00 B: 48.00 mm

114073 Starter 24 V, 5.5 kW

Replacing: FS60PR020

Servicing: Bova, DAF, Solaris

 B+ M10, Total length 319.00,
 Drive type Steel, Gear type DD/GR,
 Mount. holes 3 (0)
w/ safety switch.

Alternative no.: 115511

A: 110.00 B: 47.00 mm

114100 Starter 24 V, 7.5 kW

Replacing: D13HP709, D13HP613

Servicing: Renault V.I.

 B+ M12, Total length 380.00,
 Gear type GR, Mount. holes 3 (0)

A: 92.00 B: 47.00 mm



110601 Starter 24 V, 5.4 kW

Replacing: IM131, BNG4/24CRS165SR, BNG4/24CR165SR, 0001416013, 0001415010, 0001414017, 0001410030, 0001410029, R23.13, 6130000, AZK5193, AZK5117, AZK5113, 11.139.034, 11.130.005, 10.130.121, 9125290, 9124340, 19024578

Servicing: Mercedes-Benz, Steyr

B+ M10, Total length 384.25, Drive type Steel, Gear type DD, Mount. holes 3 (0)

A: 88.85 B: 47.50 mm



110512 Starter 24 V, 5.4 kW

Replacing: BNG4/24CRS163, BNG4/24CR231, BNG4/24, 0001416054, 0001416047, 0001416024, 0001416022, 0001415002, IM522, R23.25, R23.17, R23.16, R20Z, R20.17, 6250000, 6160000, AZK5412, AZK5194, AZK5104, 11.139.052, 11.139.035, 11.130.115, 10.130.123, 22615, 9125340, 9125320, 19024556, 19024550, 19024024

Servicing: Ahlmann, Irmer, Mercedes-Benz, Various Agriculture Vehicles

B+ M10, Total length 384.00, Drive type Steel, Gear type DD, Mount. holes 3 (0)

A: 89.00 B: 48.00 mm



DC Motors

Edition 2016/2017





110345# DC Motor 24 V, 3.0 kW
 Replacing: 24MC4TWA, 24MC42TWA, 1124-2, 1124, AMK3633, 11.212.306
 Pulley w/o, Length 225.80, Not Insulated return



110429 DC Motor 12 V, 2.0 kW
 Replacing: AMJ5632, 11.212.066, 19024660, 19024654
 Pulley w/o, Length 174.00, Not Insulated return



111091 DC Motor 24 V, 2.2 kW
 Replacing: 0136355081, 24MB22TWA, 24MB22M, 24MB21TWA, 24MB21M, 24MB1TWA, 24M1TP13, 1024, AMJ5592, 11.212.417, 19024678
 Pulley w/o, Length 195.60, Insulated return



111092 DC Motor 12 V, 2.0 kW
 Replacing: 0136355080, 12MB1WA, 12MB1TWA, 12MB1CWA, 12MB12TWA, 12MB12M, 12MB11TWA, 12MB11M, 12M1TP13, 1012, AMJ5991, AMJ5591, AMJ5272, 11.212.957, 11.212.416, 19024706
 Pulley w/o, Length 195.45, Insulated return



111466 DC Motor 24 V, 1.5 kW
 Replacing: 0136355067, 0136355061, 0136355057, 0136355042, 0136355038, 0136355037, 0136355014, 0136355012, 1424, 11.214.057, 11.212.001,
 Servicing: Volvo
 Pulley w/o, Length 200.40, Not Insulated return



111853# DC Motor 24 V, 3.0 kW
 Replacing: 24MC42THWA, 1624
 Length 252.00
 Remember ground wire to temp. sensor.



111861 DC Motor 12 V, 1.3 kW
 Replacing: MKW4007, MGL4105, FPOR4001, 462415, SM48826, MM48826, M0551046A
 Pulley w/o, Length 175.00, Not Insulated return



112311 DC Motor 12 V, 2.1 kW
 Replacing: 0136350013, AMJ5667, 11.212.108, MUE6102S
 Pulley w/o, Length 196.75, Insulated return



112317 DC Motor 12 V, 2.0 kW
 Replacing: 11.212.622, 47044616, 47044608, 47044605, MFX7012, MFX4005, MFX4004, MFX4001, MF7034, MDY7066, MDY7061, MDY7055, MDY7040, MDY7039, MDY7037, 19024743, 19024730, M11C40
 Pulley w/o, Length 191.00, Not Insulated return



112318 DC Motor 24 V, 2.5 kW
 Replacing: 11.212.619, 47044617, 47044606, MHX4001, MHJ7024, MHJ7005, MHJ7003, MDF7024, 19024732, 19024731
 Pulley w/o, Length 191.25, Not Insulated return



112487 DC Motor 24 V, 2.5 kW
 Replacing: AMJ5690, 11.212.169, 19024713, 19024709, 19024688,
 Pulley w/o, Length 191.00, Not Insulated return



112573 DC Motor 12 V, 1.6 kW
 Replacing: AMJ5705, AMJ5666, AMJ5175, 11.216.117, 11.212.609, 11.212.107
 Pulley w/o, Length 173.00, Not Insulated return



112574 DC Motor 12 V, 1.6 kW
 Replacing: AMJ4761, AMJ4635, 11.216.273
 Pulley w/o, Length 230.00,
 Not Insulated return



112575 DC motor 24 V, 2.0 kW
 Replacing: 0136501074, AMJ4762, AMJ4636,
 11.212.450
 Pulley w/o, Length 226.50,
 Not Insulated return



112576# DC Motor 12 V, 1.6 kW
 Replacing: AMJ5110, 11.212.516
 Pulley w/o, Length 185.00,
 Not Insulated return



112577 DC Motor 12 V, 1.8 kW
 Replacing: MBJ6304, MBJ6202, MBJ6201,
 MBJ4407, MBJ4402, MBJ4209, MBJ4202,
 MBJ4201, 46-4157
 Pulley w/o, Length 211.00,
 Not Insulated return
 Shaft 19.00 mm. Thread on thru bolts: 3/8
 UNFx22.50 mm.



112864 DC Motor 24 V, 0.8 kW
 Replacing: 19024729
 Pulley w/o, Length 175.00



113666 DC Motor 24 V, 2.2 kW
 Replacing: AMJ5730, AMJ5511, AMJ5176,
 11.216.257, 11.212.610, 11.212.212
 Pulley w/o, Length 173.00,
 Not Insulated return



113852# DC Motor 72 V, 5.0 kW
 Replacing: 0136603002, AMT4630
 Pulley w/o, Length 310.00
 Hydraulic.



113890 DC Motor 24 V, 2 kW
 Length 176.00



A/C Compressors



Edition 2016/2017

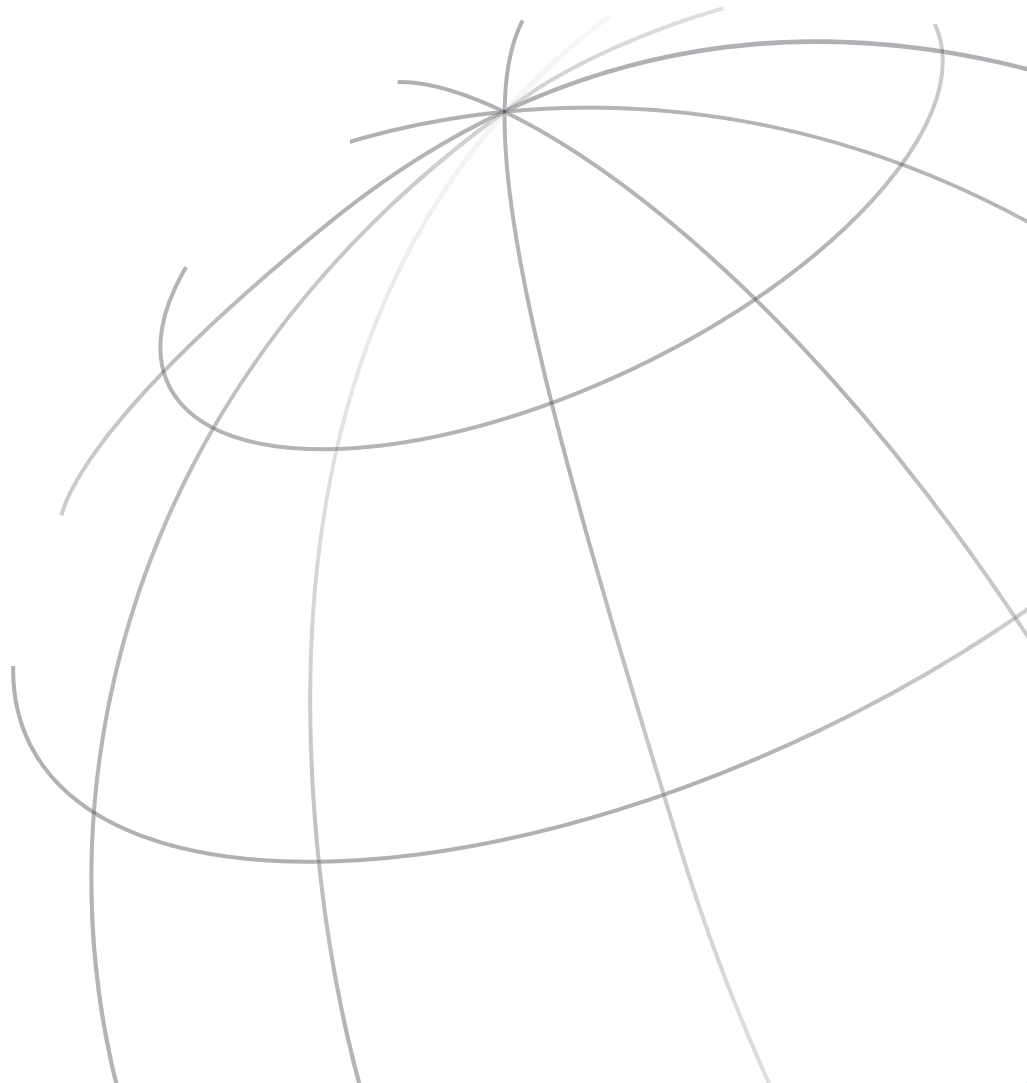



240846 Compressor

Replacing: 447170-4910

Servicing: Chevrolet, Mercedes-Benz

24 V, Pulley type SP, Grooves 9,
Oil type PAG 46, Oil capacity 180 ml.,
Refrigerant R134a

Filled with PAG oil, unless otherwise stated.

A: 130.00 B1: 55.50

B2: 27.00 C: 204.00 mm



240848  Compressor

Replacing: 447200-5750, 447170-5430

Servicing: Iveco

24 V, Pulley type SP, Grooves 4,
Oil type PAG 46, Oil capacity 200 ml.,
Refrigerant R134a

Filled with PAG oil, unless otherwise stated.

A: 110.00 B1: 27.00

B2: 38.00 C: 227.00 mm





240244 Compressor

Replacing: 1019771

Servicing: Scania

24 V, Pulley type SP, Grooves 8,
Oil type PAG 46, Oil capacity 180 ml.,
Refrigerant R134a

Filled with PAG oil, unless otherwise stated.

A: 119.00 B1: 56.50

B2: 32.00 C: 231.00 mm





240411# Compressor

Replacing: H12A0AX4ELG

Servicing: DAF

24 V, Pulley type SP, Grooves 8,

Oil type PAG 46, Oil capacity 175 ml.,

Refrigerant R134a

Filled with PAG oil, unless otherwise stated.

A: 119.00 B1: 50.00

B2: 39.50 C: 224.50 mm



240242 Compressor

Replacing: sd7h15-7834

Servicing: Volvo

 24 V, Pulley type SP, Grooves 8,
 Oil type PAG 100, Oil capacity 175 ml.,
 Refrigerant R134a

Filled with PAG oil, unless otherwise stated.

 A: 132.00 B1: 46.50
 B2: 36.00 C: 244.00 mm

240316 Compressor

 Replacing: sd7h15-9007, sd7h15-7860,
 sd508-9007

Servicing: Volvo

 24 V, Pulley type DP, Grooves 2,
 Oil type PAG 100, Oil capacity 240 ml.,
 Refrigerant R134a

Filled with PAG oil, unless otherwise stated.

 A: 132.00/110.00
 B1: 40.00
 B2: 38.50 C: 231.00 mm

240322 Compressor

Replacing: SD7H15-6028

Servicing: Volvo

 24 V, Pulley type SP, Grooves 8,
 Oil type PAG 46, Oil capacity 180 ml.,
 Refrigerant R134a

Filled with PAG oil, unless otherwise stated.

 A: 132.00 B1: 56.50
 B2: 32.50 C: 228.00 mm

240244 Compressor

 Replacing: sd7h15-8067, sd7h15-7980,
 sd7h15-7847, SD7H15-6024

Servicing: Scania

 24 V, Pulley type SP, Grooves 8,
 Oil type PAG 46, Oil capacity 180 ml.,
 Refrigerant R134a

Filled with PAG oil, unless otherwise stated.

 A: 119.00 B1: 56.50
 B2: 32.00 C: 231.00 mm

240320# Compressor

Replacing: sd7h15-7982

Servicing: Volvo

 24 V, Pulley type DP, Grooves 2,
 Oil type PAG 100, Oil capacity 175 ml.,
 Refrigerant R134a

Filled with PAG oil, unless otherwise stated.

 A: 132.00 B1: 40.50
 B2: 36.50 C: 231.50 mm

240323 Compressor

Replacing: sd7h15-8068, sd7h15-7981

 24 V, Pulley type DP, Grooves 2,
 Oil type PAG 46, Oil capacity 240 ml.,
 Refrigerant R134a

Filled with PAG oil, unless otherwise stated.

 A: 132.00 B1: 50.00
 B2: 32.00 C: 230.00 mm

240315 Compressor

Replacing: sd7h15-7808

Servicing: Volvo

 24 V, Pulley type DP, Grooves 2,
 Oil type PAG 100, Oil capacity 175 ml.,
 Refrigerant R134a

Filled with PAG oil, unless otherwise stated.

 A: 132.00 B1: 39.50
 B2: 38.50 C: 218.00 mm

240321 Compressor

Replacing: sd7h15-8003

Servicing: Volvo

 24 V, Pulley type SP, Grooves 8,
 Oil type PAG 46, Oil capacity 175 ml.,
 Refrigerant R134a

Filled with PAG oil, unless otherwise stated.

 A: 132.00 B1: 46.50
 B2: 35.50 C: 233.00 mm

240327 Compressor

 Replacing: sd7h15-8236, sd7h15-8017,
 sd7h15-7866

Servicing: MAN, Sandvik

 24 V, Pulley type DP, Grooves 2,
 Oil type PAG 46, Oil capacity 135 ml.,
 Refrigerant R134a

Filled with PAG oil, unless otherwise stated.

 A: 132.00 B1: 39.50
 B2: 38.50 C: 216.50 mm



240328 Compressor
 Replacing: sd7h15-8239, sd7h15-8061, sd7h15-7824, SD508-9532, sd508-8399
 Servicing: DAF, Moxy, Scania
 24 V, Pulley type DP, Grooves 2,
 Oil type PAG 46, Oil capacity 207 ml.,
 Refrigerant R134a
Filled with PAG oil, unless otherwise stated.
 A: 132.00 B1: 39.50
 B2: 38.50 C: 220.00 mm



240349 Compressor
 Replacing: sd7h15-8240, sd7h15-8086
 Servicing: Various
 24 V, Pulley type SP, Grooves 8,
 Oil type PAG 46, Oil capacity 135 ml.,
 Refrigerant R134a
Filled with PAG oil, unless otherwise stated.
 A: 119.00 B1: 50.00
 B2: 39.50 C: 210.00 mm



240394 Compressor
 Replacing: sd7h15-4726
 Servicing: Caterpillar
 24 V, Pulley type SP, Grooves 8,
 Oil type PAG 46, Oil capacity 190 ml.,
 Refrigerant R134a
Filled with PAG oil, unless otherwise stated.
 A: 133.00 B1: 45.50
 B2: 34.50 C: 139.50 mm



240396 Compressor
 Replacing: sd7h15-8064, SD7H15-4656, SD7H15-4604
 Servicing: Caterpillar
 24 V, Pulley type P, Grooves 1,
 Oil type PAG 100, Oil capacity 300 ml.,
 Refrigerant R134a
Filled with PAG oil, unless otherwise stated.
 A: 138.00 B1: 39.50
 B2: 54.00 C: 230.50 mm



240398 Compressor
 Replacing: sd7h15-8066, sd7h15-4658, sd7h15-4640, SD7H15-4479
 Servicing: Caterpillar
 24 V, Pulley type P, Grooves 1,
 Oil type PAG 100, Oil capacity 300 ml.,
 Refrigerant R134a
Filled with PAG oil, unless otherwise stated.
 A: 153.00 B1: 39.50
 C: 241.50 mm



240400 Compressor
 Replacing: sd7h15-4769
 Servicing: Caterpillar
 24 V, Pulley type SP, Grooves 8,
 Oil type PAG 46, Oil capacity 190 ml.,
 Refrigerant R134a
Filled with PAG oil, unless otherwise stated.
 A: 133.50 B1: 61.50
 B2: 36,50 C: 249.50 mm



240401 Compressor
 Replacing: sd7h15-4840
 Servicing: Caterpillar
 24 V, Pulley type SP, Grooves 8,
 Oil type PAG 100, Oil capacity 300 ml.,
 Refrigerant R134a
Filled with PAG oil, unless otherwise stated.
 A: 152.00 B1: 61.50
 B2: 36.50 C: 245.50 mm



240410 Compressor
 Replacing: sd7h15-8182, sd7h15-8127, sd7h15-8051, sd7h15-7856
 Servicing: DAF
 24 V, Pulley type P, Grooves 1,
 Oil type PAG 46, Oil capacity 175 ml.,
 Refrigerant R134a
Filled with PAG oil, unless otherwise stated.
 A: 133.00 B1: 29.00
 B2: 43.50 C: 218.50 mm



240411# 5★ Compressor
 Replacing: sd7h15-8129
 Servicing: DAF
 24 V, Pulley type SP, Grooves 8,
 Oil type PAG 46, Oil capacity 175 ml.,
 Refrigerant R134a
Filled with PAG oil, unless otherwise stated.
 A: 119.00 B1: 50.00
 B2: 39.50 C: 224.50 mm



240417 Compressor

Replacing: sd7h15-8144, sd7h15-8090

Servicing: Iveco

 24 V, Pulley type SP, Grooves 8,
 Oil type PAG 46, Oil capacity 200 ml.,
 Refrigerant R134a

Filled with PAG oil, unless otherwise stated.

 A: 119.00 B1: 52.00
 B2: 27.00 C: 230.50 mm

240430 Compressor

Replacing: sd7h15-8117, sd7h15-6008

Servicing: MAN, Opel

 24 V, Pulley type SP, Grooves 8,
 Oil type PAG 46, Oil capacity 150 ml.,
 Refrigerant R134a

Filled with PAG oil, unless otherwise stated.

 A: 119.00 B1: 46.50
 B2: 36.00 C: 223.50 mm

240448 Compressor

Replacing: sd7h15-7809

Servicing: Volvo

 24 V, Pulley type DP, Grooves 2,
 Oil type PAG 100, Oil capacity 180 ml.,
 Refrigerant R134a

Filled with PAG oil, unless otherwise stated.

 A: 125.00 B1: 39.50
 B2: 38.00 C: 205.00 mm

240424 Compressor

Replacing: sd7h15-8163, sd7h15-4652

Servicing: JCB

 24 V, Pulley type DP, Grooves 2,
 Oil type PAG 46, Oil capacity 240 ml.,
 Refrigerant R134a

Filled with PAG oil, unless otherwise stated.

 A: 132.00 B1: 39.00
 B2: 38.00 C: 220.00 mm

240431 Compressor

Replacing: sd7h15-8157, sd7h15-6011

Servicing: MAN

 24 V, Pulley type DP, Grooves 2,
 Oil type PAG 46, Oil capacity 150 ml.,
 Refrigerant R134a

Filled with PAG oil, unless otherwise stated.

 A: 132.00 B1: 39.50
 B2: 38.00 C: 330.00 mm

240449 Compressor

Replacing: sd7h15-8045

Servicing: Volvo

 24 V, Pulley type DP, Grooves 2,
 Oil type PAG 100, Oil capacity 240 ml.,
 Refrigerant R134a

NB! 1 pin connector. Filled with PAG oil, unless otherwise stated.

 A: 132.00 B1: 39.50
 B2: 38.00 C: 227.00 mm

240426 Compressor

Replacing: sd7h15-8120, sd7h15-6046

Servicing: DAF

 24 V, Pulley type SP, Grooves 8,
 Oil type PAG 46, Oil capacity 190 ml.,
 Refrigerant R134a

Filled with PAG oil, unless otherwise stated.

 A: 119.00 B1: 50.00
 B2: 39.00 C: 214.00 mm

240445 Compressor

Replacing: sd7h15-7848

Servicing: DAF, Scania

 24 V, Pulley type DP, Grooves 2,
 Oil type PAG 100, Oil capacity 180 ml.,
 Refrigerant R134a

Filled with PAG oil, unless otherwise stated.

 A: 132.00 B1: 50.00
 B2: 34.50 C: 226.00 mm

240450 Compressor

Replacing: sd7h15-8053, sd7h15-7972

Servicing: Volvo

 24 V, Pulley type DP, Grooves 2,
 Oil type PAG 46, Oil capacity 240 ml.,
 Refrigerant R134a

Filled with PAG oil, unless otherwise stated.

 A: 132.00 B1: 39.50
 B2: 38.50 C: 218.00 mm



240452 Compressor
 Replacing: sd7h15-8112
 Servicing: MAN, Mitsubishi, Renault V.I., Scania, Volvo
 24 V, Pulley type SP, Grooves 8, Oil type PAG 46, Oil capacity 240 ml., Refrigerant R134a
Filled with PAG oil, unless otherwise stated.
 A: 132.00 B1: 56.50
 B2: 31.50 C: 223.50 mm



240457 Compressor
 Replacing: sd5h14-6652
 Servicing: Various
 24 V, Pulley type SP, Grooves 8, Oil type PAG 100, Oil capacity 210 ml., Refrigerant R134a
Filled with PAG oil, unless otherwise stated.
 A: 119.00 B1: 46.50
 B2: 36.00 C: 207.50 mm



240458 Compressor
 Replacing: sd7h15-8233, sd7h15-8139
 Servicing: Liebherr
 24 V, Pulley type SP, Grooves 8, Oil type PAG 46, Oil capacity 180 ml., Refrigerant R134a
Filled with PAG oil, unless otherwise stated.
 A: 118.00 B1: 46.00
 B2: 36.50 C: 213.00 mm



240535 Compressor
 Replacing: sd5h14-6627, sd5h14-4507, SD5H14-4506, sd508-5472
 Servicing: Various
 24 V, Pulley type DP, Grooves 2, Oil type PAG 100, Oil capacity 175 ml., Refrigerant R134a
Filled with PAG oil, unless otherwise stated.
 A: 132.00 B1: 39.50
 B2: 38.50 C: 216.50 mm



240539 Compressor
 Replacing: sd5h14-6634, SD5H14-4537
 Servicing: Moxly
 24 V, Pulley type DP, Grooves 2, Oil type PAG 100, Oil capacity 175 ml., Refrigerant R134a
Filled with PAG oil, unless otherwise stated.
 A: 132.00 B1: 39.50
 B2: 38.00 C: 227.00 mm



240621[#] Compressor
 Replacing: sd7h15-4866
 Servicing: Various
 24 V, Pulley type SP, Grooves 8, Oil type PAG 100, Oil capacity 200 ml., Refrigerant R134a
Filled with PAG oil, unless otherwise stated.
 A: 119.00 B1: 46.50
 B2: 36.00 C: 223.00 mm



240623 Compressor
 Replacing: sd7h15-7933
 Servicing: Iveco
 24 V, Pulley type DP, Grooves 2, Oil type PAG 100, Oil capacity 207 ml., Refrigerant R134a
Filled with PAG oil, unless otherwise stated.
 A: 132.00 B1: 39.50
 B2: 38.00 C: 230.00 mm



240745 Compressor
 Replacing: sd5h14-6623
 Servicing: Various
 24 V, Pulley type DP, Grooves 2, Oil type PAG 100, Oil capacity 200 ml., Refrigerant R134a
Filled with PAG oil, unless otherwise stated.
 A: 152.50 B1: 39.50
 B2: 36.50 C: 206.50 mm



241071 Compressor
 Replacing: SD7H15-8231, SD7H15-4002
 Servicing: DAF
 24 V, Pulley type Triple Pulley, Grooves 7, Oil type PAG 46, Oil capacity 135 ml., Refrigerant R134a
Filled with PAG oil, unless otherwise stated.
 A: 135.00 B1: 57.50
 B2: 36.00 C: 214.00 mm



241078 Compressor

Replacing: sd7H15-4324

Servicing: Volvo

 24 V, Pulley type SP, Grooves 8,
 Oil type PAG 46, Oil capacity 175 ml.,
 Refrigerant R134a

Filled with PAG oil, unless otherwise stated.

 A: 176.00 B1: 56.50
 B2: 32.00 C: 235.00 mm

NEW PRODUCT
www.hc-cargo.com
241194 Compressor

Replacing: SD7H15-8242, SD7H-6034

Servicing: Volvo

 24 V, Pulley type Triple Pulley,
 Grooves 8, Oil type PAG 46,
 Oil capacity 200 ml., Refrigerant R134a

Filled with PAG oil, unless otherwise stated.

 A: 132.00 B1: 56.50
 B2: 31.50 C: 225.00 mm

241129 Compressor

Replacing: sd7h15-7948

Servicing: Iveco

 24 V, Pulley type SP, Grooves 1,
 Oil type PAG 100, Oil capacity 200 ml.,
 Refrigerant R134a

Filled with PAG oil, unless otherwise stated.

 A: 135.00 B1: 39.50
 B2: 54.00 C: 235.00 mm

NEW PRODUCT
www.hc-cargo.com
241214* Compressor

Replacing: SD7H15-6035

Servicing: Volvo

 24 V, Refrigerant R134a
*NB! 2 pin connector. Filled with PAG oil,
 unless otherwise stated.*
NEW PRODUCT
www.hc-cargo.com
241152* Compressor

Replacing: SD7H15-8192, SD7H15-6093

Servicing: Renault V.I.

24 V, Refrigerant R134a

Filled with PAG oil, unless otherwise stated.
NEW PRODUCT
www.hc-cargo.com
241184* Compressor

Replacing: SD7H15-8215

Servicing: Volvo



240996 Compressor
 Servicing: Various
 24 V, Pulley type DP, Grooves 2,
 Oil type PAG 46, Oil capacity 150 ml.,
 Refrigerant R134a
Filled with PAG oil, unless otherwise stated.
 A: 125.00 B1: 44.00
 B2: 40.50 C: 197.00 mm



NEW PRODUCT
www.hc-cargo.com

241070* Compressor
 Replacing: 1864125
 Servicing: Various
 24 V, Refrigerant R134a
Filled with PAG oil, unless otherwise stated.



241072 Compressor
 Replacing: A5412301211, A5412300611,
 5412301211, 5412300611
 Servicing: Mercedes-Benz
 24 V, Pulley type Triple Pulley,
 Grooves 9, Oil type PAG 46,
 Oil capacity 200 ml., Refrigerant R134a
Filled with PAG oil, unless otherwise stated.
 A: 130.00 B1: 63.50
 B2: 35.00 C: 231.00 mm



241073 Compressor
 Replacing: A5412301311, 5412301311
 Servicing: Chevrolet, MAN, Mercedes-Benz
 24 V, Pulley type Triple Pulley,
 Grooves 11, Oil type PAG 46,
 Oil capacity 150 ml., Refrigerant R134a
Filled with PAG oil, unless otherwise stated.
 A: 130.00 B1: 70.50
 B2: 35.00 C: 230.00 mm



241075 Compressor
 Replacing: 51.77970.7026, 51.77970.7015
 Servicing: MAN, Volvo
 24 V, Pulley type SP, Grooves 8,
 Oil type PAG 46, Oil capacity 200 ml.,
 Refrigerant R134a
Filled with PAG oil, unless otherwise stated.
 A: 119.00 B1: 46.50
 B2: 36.00 C: 220.00 mm



241076 Compressor
 Replacing: 81.61906.6012, 51.77970.7028
 Servicing: MAN, Mercedes-Benz
 24 V, Pulley type SP, Grooves 8,
 Oil type PAG 46, Oil capacity 150 ml.,
 Refrigerant R134a
Filled with PAG oil, unless otherwise stated.
 A: 119.00 B1: 46.50
 B2: 36.00 C: 220.00 mm



241077 Compressor
 Replacing: 1888033, 1853081
 Servicing: Hyundai, Scania
 24 V, Pulley type SP, Grooves 8,
 Oil type PAG 46, Oil capacity 200 ml.,
 Refrigerant R134a
Filled with PAG oil, unless otherwise stated.
 A: 119.00 B1: 56.00
 B2: 31.00 C: 234.00 mm



NEW PRODUCT
www.hc-cargo.com

241079* Compressor
 Replacing: A9062300111, 9062300111
 Servicing: Mercedes-Benz
 24 V, Refrigerant R134a
Filled with PAG oil, unless otherwise stated.



241102 Compressor
 Replacing: 1888032, 1531196
 Servicing: Fiat, Scania
 24 V, Pulley type Triple Pulley,
 Grooves 10, Oil type PAG 46,
 Oil capacity 240 ml., Refrigerant R134a
Filled with PAG oil, unless otherwise stated.
 A: 120.00 B1: 63.50
 B2: 31.50 C: 236.00 mm



NEW PRODUCT
www.hc-cargo.com

241135 Compressor
 Replacing: 85000950, 85000724, 7420941036,
 5010605474, 20941036, 20731328, 2016303734
 Servicing: Renault V.I., Volvo
 24 V, Pulley type Triple Pulley,
 Grooves 10, Oil type PAG 46,
 Oil capacity 240 ml., Refrigerant R134a
Filled with PAG oil, unless otherwise stated.
 A: 120.00 B1: 63.50
 B2: 31.50 C: 232.00 mm





Dryers

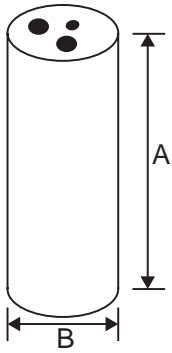

Edition 2016/2017

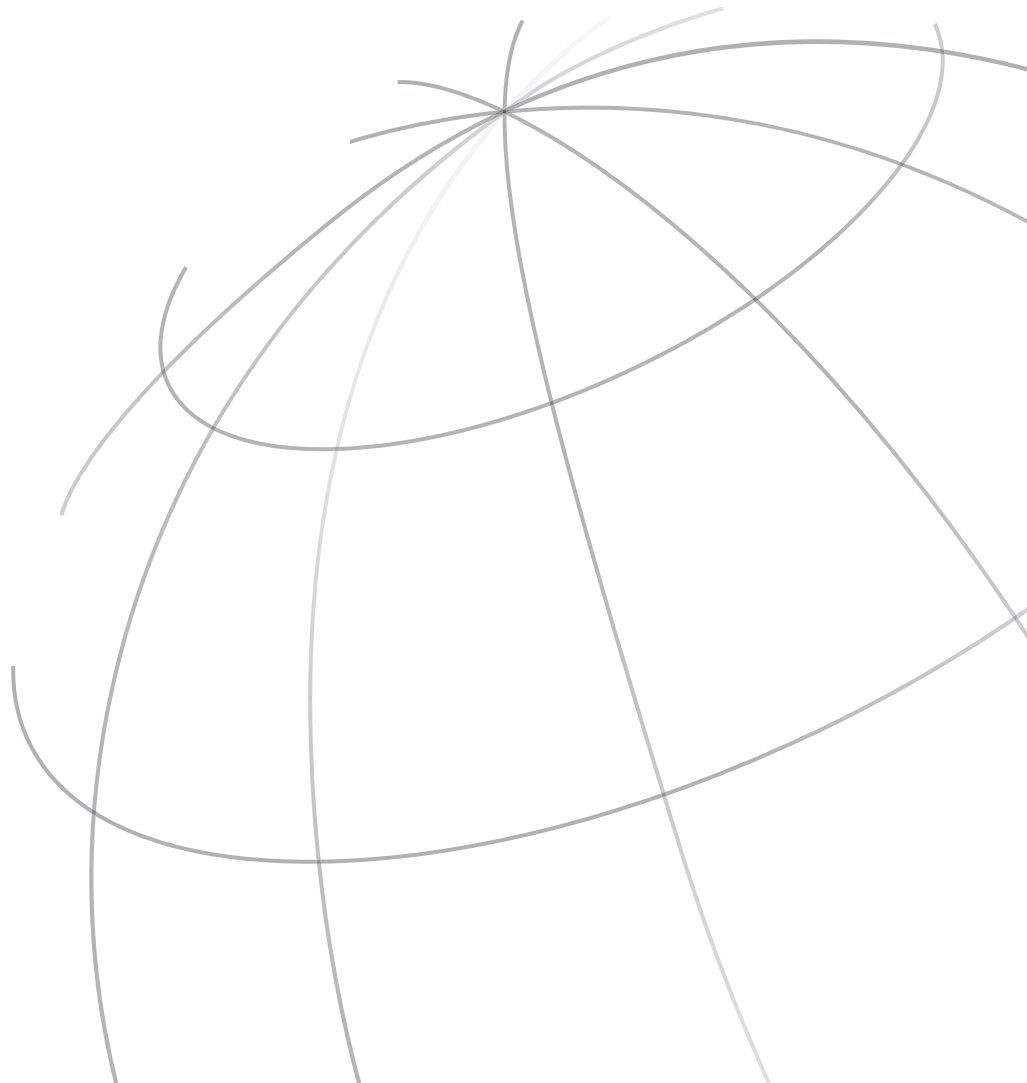



260971 Dryer
 Replacing: 1516767, 1337496
 Servicing: Scania, Volvo
 A: 245.00 B: 75.00 mm



260976 Dryer
 Replacing: 1321891
 Servicing: DAF, Ford
 A: 123.00 B: 52.00 mm



260980 Dryer
 Replacing: A9738300183, A9708300283, 9738300183, 9708300283, 260986
 Servicing: Fiat, Mercedes-Benz
 A: 200.00 B: 64.00 mm



260972 Dryer
 Replacing: 81.61910.6045, 81.61910.6023, 81.61910.6017
 Servicing: MAN
 A: 403.00 B: 45.00 mm



260977 Dryer
 Replacing: 1782912, 1698300, 1371366
 Servicing: DAF, Peugeot
 A: 203.00 B: 63.00 mm



260981 Dryer
 Replacing: A0008302483, 0008302483
 Servicing: Chevrolet, Mercedes-Benz, Volvo
 A: 280.00 B: 50.00 mm



260973 Dryer
 Replacing: A0008301583, 0008301583
 Servicing: Mercedes-Benz
 A: 290.00 B: 51.00 mm



260978 Dryer
 Replacing: A0008301783, 81.61910.6012, 81.61910.0013, 0008301783
 Servicing: Mercedes-Benz
 A: 290.00 B: 53.00 mm



260982 Dryer
 Replacing: 8142079, 260974, 20490945, 1618848
 Servicing: Volvo
 A: 226.00 B: 75.00 mm

NEW PRODUCT
www.hc-cargo.com

260975 Dryer
 Replacing: 98482342
 Servicing: Iveco, Seat, VW
 A: 228.00 B: 76.00 mm



260979 Dryer
 Replacing: 1772730
 Servicing: Fiat, MAN, Scania
 A: 173.00 B: 98.00 / 96.00 mm



260983 Dryer
 Replacing: A0008302083, 0008302083
 Servicing: Mercedes-Benz
 A: 290.00 B: 53.00 mm

260984 Dryer

Replacing: 98343658

Servicing: Iveco

A: 435.00 B: 29.00 mm

NEW PRODUCT
www.hc-cargo.com

260985* Dryer

Replacing: A0008301883, 0008301883

Servicing: Mercedes-Benz

NEW PRODUCT
www.hc-cargo.com

261034* Dryer

Replacing: 7N0898191

Servicing: Honda, VW

NEW PRODUCT
www.hc-cargo.com

261035* Dryer

Replacing: 9202689, 64509202689

Servicing: BMW

NEW PRODUCT
www.hc-cargo.com

261070* Dryer

Replacing: 92131-JD50B

Servicing: Nissan



Condensers

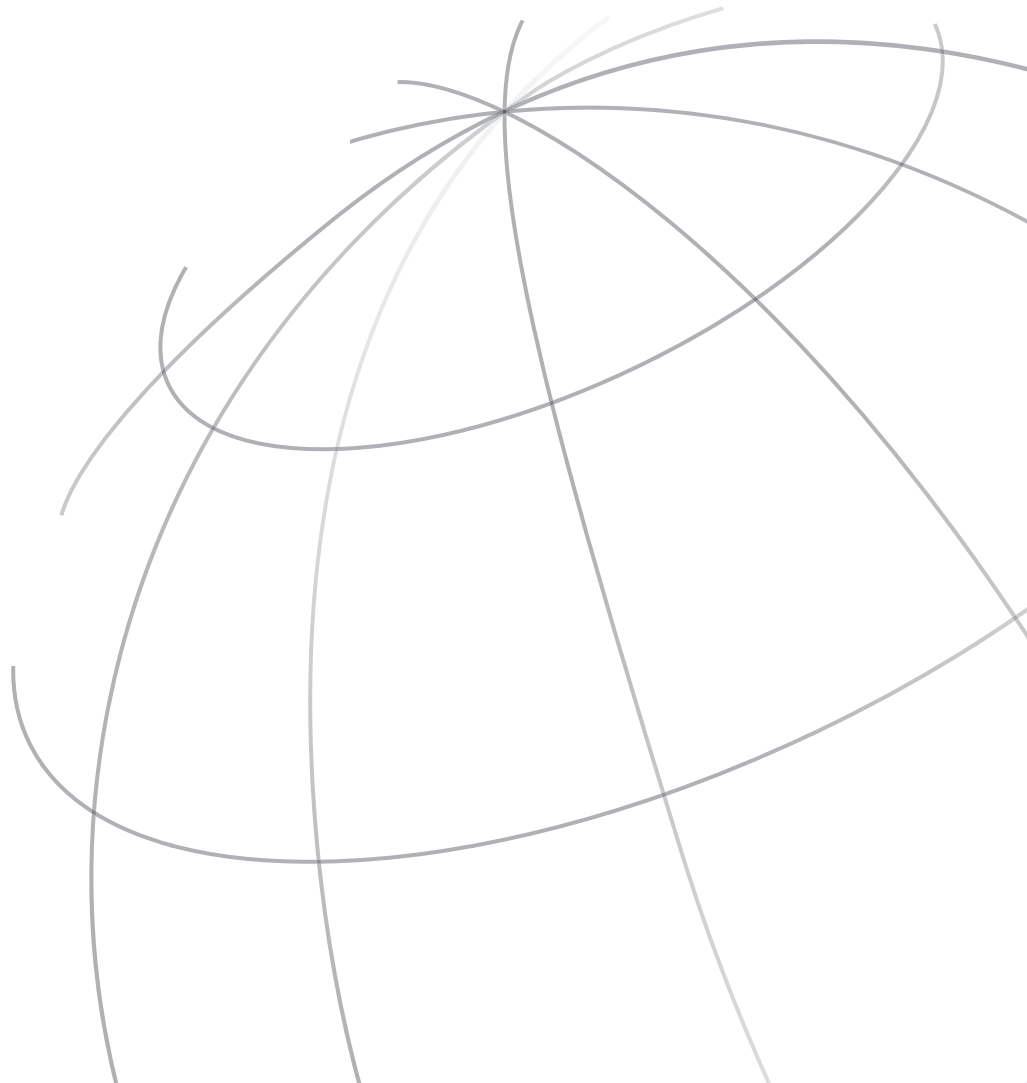
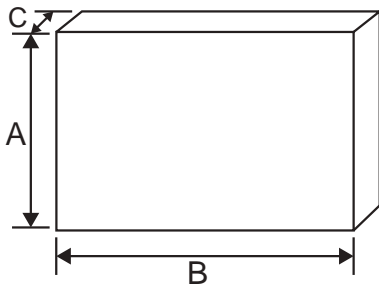

Edition 2016/2017





260987 Condenser
 Replacing: 1449757, 1354110
 Servicing: Mitsubishi, Scania
 Dryer w/o
 A: 460.00 B: 820.00 C: 22.00 mm



260988 Condenser
 Replacing: 81.61920.0030, 81.61920.0029,
 81.61920.0027, 81.61920.0023,
 81.61920.0018
 Servicing: MAN
 Dryer w/o
 A: 352.00 B: 790.00 C: 20.00 mm

NEW PRODUCT
www.hc-cargo.com

260989* Condenser
 Replacing: 1449779, 1380374
 Servicing: Scania

NEW PRODUCT
www.hc-cargo.com

260990* Condenser
 Replacing: 8144689
 Servicing: Volvo



260991 Condenser
 Replacing: 93194748, 533770202
 Servicing: Iveco, Volvo
 Dryer w/o
 A: 423.00 B: 530.00 C: 22.00 mm

NEW PRODUCT
www.hc-cargo.com

260992* Condenser
 Replacing: 1321833
 Servicing: DAF

NEW PRODUCT
www.hc-cargo.com

260993* Condenser
 Replacing: 81.61920.6026, 81.61920.6019
 Servicing: MAN



260994 Condenser
 Replacing: 1371355
 Servicing: DAF
 Dryer w/o
 A: 438.00 B: 505.00 C: 20.00 mm



260995 Condenser
 Replacing: A9425000154, A9425000054,
 9425000154, 9425000054
 Servicing: Chevrolet, Mercedes-Benz
 Dryer w/o
 A: 460.00 B: 755.00 C: 31.00 mm

NEW PRODUCT
www.hc-cargo.com

260996* Condenser
 Replacing: 8144690
 Servicing: Volvo



260997 Condenser
 Replacing: 1790840, 1780227, 1446258
 Servicing: Holden, Scania
 Dryer w/o
 A: 382.00 B: 760.00 C: 20.00 mm



260998 Condenser
 Replacing: A9705000054, 9705000054
 Servicing: Fiat, Mercedes-Benz
 Dryer w/o
 A: 540.00 B: 536.00 C: 20.00 mm



260999 Condenser
 Replacing: 1752264
 Servicing: Fiat, Scania
 Dryer w/o
 A: 380.00 B: 745.00 C: 20.00 mm

NEW PRODUCT
www.hc-cargo.com

261000* Condenser
 Replacing: 81.61920.0012
 Servicing: MAN



261001 Condenser
 Replacing: 8189330
 Servicing: Iveco
 Dryer w/o
 A: 480.00 B: 690.00 C: 39.00 mm

NEW PRODUCT
www.hc-cargo.com

261002 Condenser
 Replacing: 41214450
 Servicing: Iveco
 Dryer w/
 A: 475.00 B: 695.00 C: 20.00 mm



261003 Condenser
 Replacing: 3980841, 21086309, 20838905, 20515134
 Servicing: Volvo
 Dryer w/o
 A: 341.00 B: 840.00 C: 25.00 mm



261004 Condenser
 Replacing: 504238741, 504080822
 Servicing: Iveco
 Dryer w/
 A: 348.00 B: 490.00 C: 22.00 mm

NEW PRODUCT
www.hc-cargo.com

261005* Condenser
 Replacing: 3962652
 Servicing: Volvo

NEW PRODUCT
www.hc-cargo.com

261006* Condenser
 Replacing: 504022659
 Servicing: Iveco

NEW PRODUCT
www.hc-cargo.com

261007 Condenser
 Replacing: 1387308, 1327759
 Servicing: DAF
 Dryer w/o
 A: 790.00 B: 680.00 C: 36.00 mm

NEW PRODUCT
www.hc-cargo.com

261008* Condenser
 Replacing: 81.61920.6028
 Servicing: MAN



261009 Condenser
 Replacing: 21086300, 20838901, 20555299
 Servicing: Volvo
 Dryer w/o
 A: 375.00 B: 835.00 C: 25.00 mm



261010 Condenser
 Replacing: 1629115
 Servicing: DAF
 Dryer w/o
 A: 540.00 B: 543.00 C: 20.00 mm



261011 Condenser

Replacing: A9705000154, 9705000154

Servicing: Mercedes-Benz

Dryer w/

A: 540.00 B: 500.00 C: 20.00 mm



Universal Parts

Edition 2016/2017



Oil

Specified Oil



250305 PAG 46 oil
Refrigerant R134a, Viscosity PAG 46,
Content 237 ml



250306 PAG 100 oil
Refrigerant R134a, Viscosity PAG 100,
Content 237 ml



250307 PAG 150 oil
Refrigerant R134a, Viscosity PAG 150,
Content 237 ml



253483 PAG 46 Oil + UV dye
Refrigerant R134a, Viscosity PAG 46,
Content 237 ml
w/ UV dye.



253484 PAG 100 Oil + UV dye
Refrigerant R134a, Viscosity PAG 100,
Content 237 ml,
w/ UV dye.



253485 PAG 150 Oil + UV dye
Refrigerant R134a, Viscosity PAG 150,
Content 237 ml
w/ UV dye.



253490 PAG 46 Oil + UV dye
Refrigerant R134a, Viscosity PAG 46,
Content 946 ml,
w/ UV dye.



253491 PAG 100 Oil + UV dye
Refrigerant R134a, Viscosity PAG 100,
Content 946 ml,
w/ UV dye.



253492 PAG 150 Oil + UV dye
Refrigerant R134a, Viscosity PAG 150,
Content 946 ml
w/ UV dye.

Universal Oil



253486 Ester Oil + UV Dye
Refrigerant R134a, Content 237 ml
w/ UV dye.



253487 Ester Oil + UV Dye
Refrigerant R134a, Content 946 ml
w/ UV dye.



253520 PAO-oil 68
Refrigerant R134a, Viscosity PAO 68,
Content 946 ml



253521 PAO-oil 68 with UV dye
Refrigerant R134a, Viscosity PAO 68,
Content 946 ml
w/ UV dye.

253522 PAG 46

Refrigerant R134a, Viscosity PAG 46,
Content 946 ml

253523 PAG 100

Refrigerant R134a, Viscosity PAG 100,
Content 946 ml

253524 PAG 150

Refrigerant R134a, Viscosity PAG 150,
Content 946 ml

Tools

253527 Compressor Tester

The HC-CARGO tester comes with: • 1 set of power leads and wire harness. • 1 set connector/adaptor for various EU applications and universals. • 1 instruction guide.

253528 Temperature Testing Tool

Temp. -3.89°C - 121.11°C (25°F - 250°F)
The HC-CARGO tester comes with: • Manual incl. calculation sheet for converting measurements.

Various

253517 U/V Leak detection dye

Refrigerant R134a, Content 237 ml

253577 UV Leak detector dye

Refrigerant R134a, Content 936 ml



253579 Ultimate Degreaser for UV dye

Refrigerant R134a, Content 473 ml

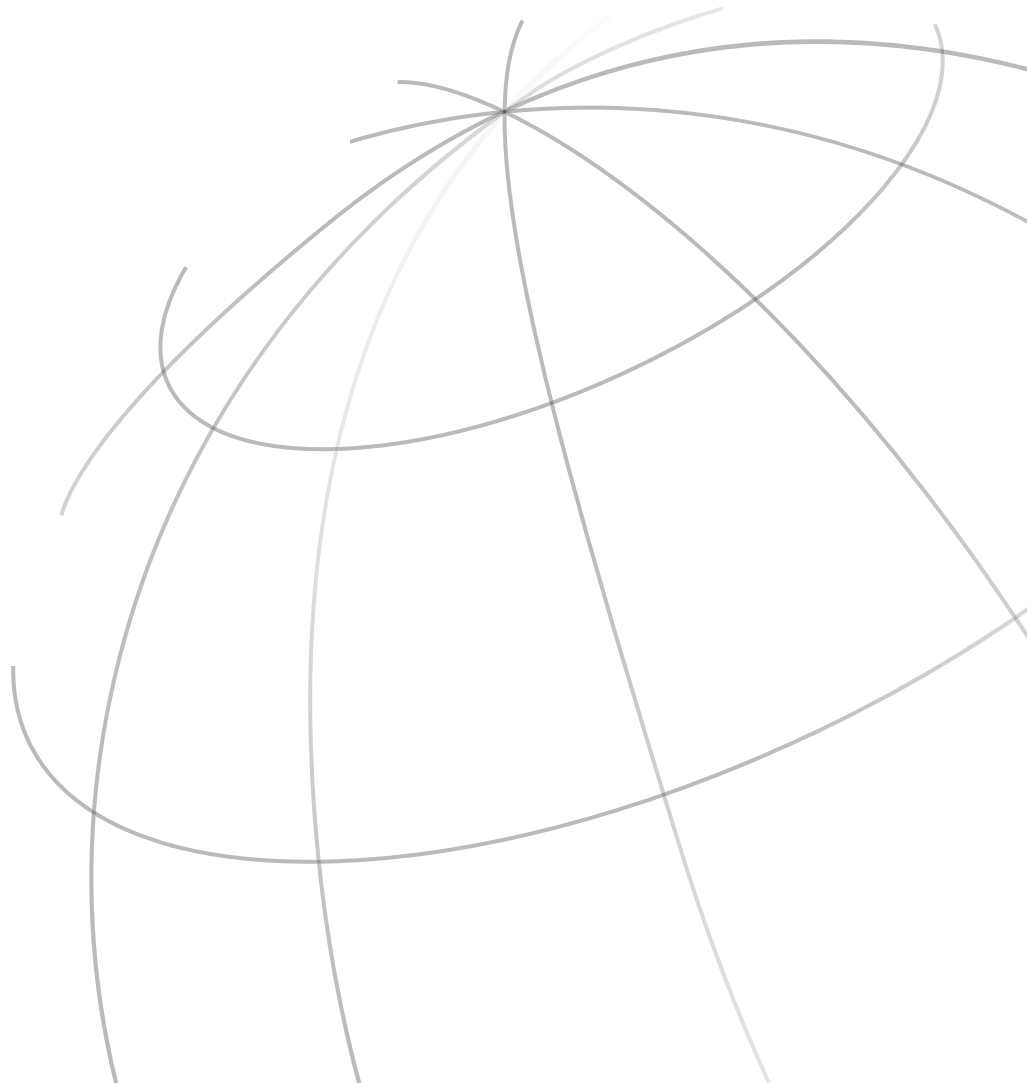

Lighting

Edition 2016/2017



INTERIOR LAMPS LED

171676 LED Interior Lamp

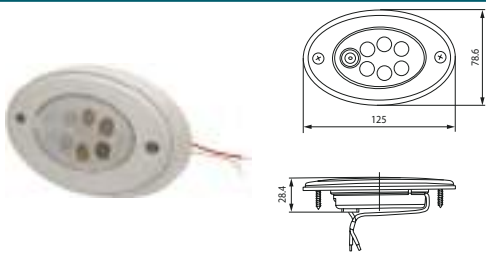

Voltage: 12/24
Watt: 0.7

Dim.: 125x78.6x28.4 mm
Cable length: 120 mm
Dist. mount. holes: 100 mm

Type: LED
Colour: White
Colour/glass: Frosted
Material: Shockproof plastic
Material/dome: PMMA
Shape: Oval
Switch: w/
No./LEDs: 6
Approvals: CE/UL

171677 LED Interior Lamp

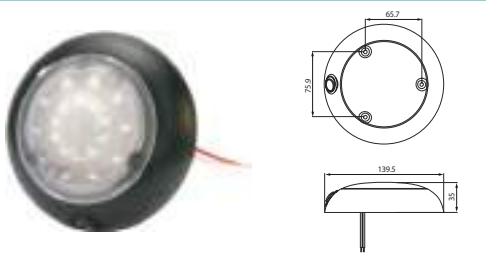

Voltage: 12/24
Watt: 1.5

Dim.: 139.5x35 mm
Cable length: 210 mm
Dist. mount. holes: 75 mm

Type: LED
Colour: Black
Colour/glass: Frosted
Material: Shockproof plastic
Material/dome: PMMA
Shape: Circular
Mount.: Plan installation
Switch: w/
No./LEDs: 20
Approvals: CE

171679 LED Interior Lamp

180° adjustable.

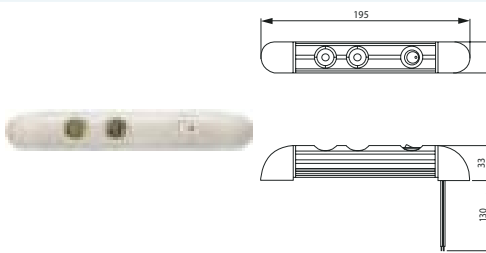

Voltage: 9-30
Watt: 3

Dim.: 195x30x33 mm
Cable length: 130 mm
Dist. mount. holes: 164 mm

Type: LED
Colour: White
Colour/glass: Transparent
Material: Alu/plastic
Material/dome: PMMA
Shape: Oblong
Switch: w/
No./LEDs: 2
Approvals: CE

171695 LED Interior Lamp

For flush mounting.

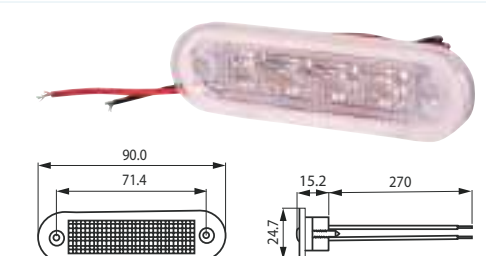

Voltage: 12/24

Dim.: 90x24.7 mm
Cable length: 270 mm
Dist. mount. holes: 71.4 mm

Type: LED
Colour: White
Colour/glass: Frosted
Material: Shockproof plastic
Material/dome: PMMA
Shape: Oval
Mount.: Plan installation
No./LEDs: 4
Tightness norm: IP 66
Approvals: CE

171696 LED Interior Lamp

For flush mounting.

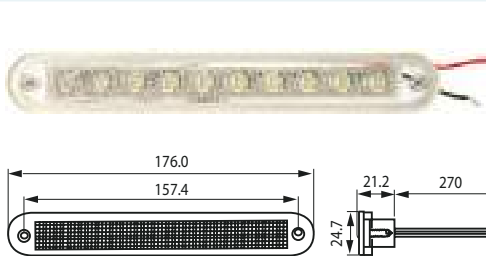

Voltage: 12/24
Watt: 0.8

Dim.: 176x24.7x21.2 mm
Cable length: 270 mm
Dist. mount. holes: 157.4 mm

Type: LED
Colour: White
Colour/glass: Frosted
Material: Shockproof plastic
Material/dome: PMMA
Shape: Oval
Mount.: Plan installation
No./LEDs: 10
Tightness norm: IP 66
Approvals: CE

171750 LED Interior Lamp



Voltage: 12/24

Dim.: 177x15.7 mm
Cable length: 500 mm
Dist. mount. holes: 140 mm

Type: LED
Colour: Chrome
Colour/glass: Frosted
Material: Shockproof plastic
Material/dome: PMMA
Shape: Round
Mount.: Plan installation
No./LEDs: 39
Tightness norm: IP 56

171767 LED Interior Lamp

Suited for flush mounting.

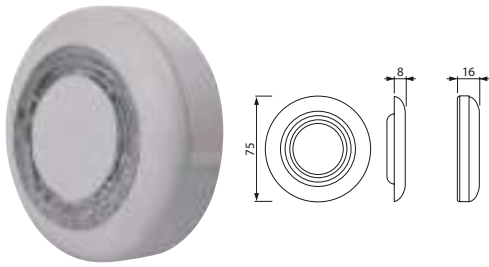

Voltage: 9-30
Watt: 0.8

Dim.: 75x16 mm
Cable length: 120 mm
Dist. mount. holes:
53 mm

Type: Interior lamp
Colour: White
Colour/glass: Transparent
Material: Shockproof plastic
Material/dome: PMMA
Shape: Round
Mount.: 3 screws
Switch: w/
No./LEDs: 1
Approvals: CE

171768 LED Interior Lamp

Suited for flush mounting.

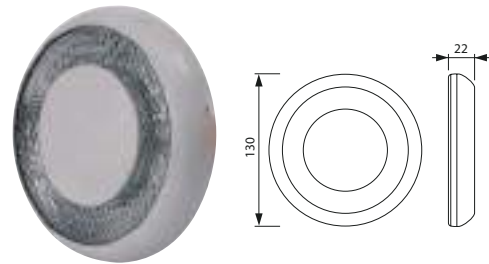

Voltage: 9-30
Watt: 2.8

Dim.: 130x22 mm
Cable length: 120 mm
Dist. mount. holes:
100 mm

Type: Interior lamp
Colour: White
Colour/glass: Frosted
Material: Shockproof plastic
Material/dome: PMMA
Shape: Round
Mount.: 3 screws
Switch: w/
No./LEDs: 1
Approvals: CE

171769 LED Reading lamp

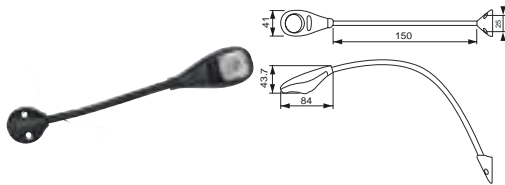

Voltage: 9-30
Watt: 1.8

Dim.: 150 mm
Cable length: 120 mm
Dist. mount. holes:
25 mm

Type: Interior lamp
Colour: Black
Colour/glass: Frosted
Material: ABS plastic/aluminium
Material/dome: Polycarbonate
Shape: w/ adjustable metal arm
Mount.: 2 screws
Switch: w/
No./LEDs: 1
Approvals: CE

171773 LED Interior Lamp HD

Servicing: Suited for use in refrigeration vehicles

Suited for flush mounting.

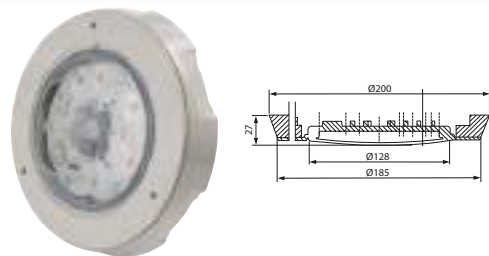

Voltage: 10-32
Watt: 8/9

Dim.: 200x27 mm
Dist. mount. holes:
137 mm

Type: Interior lamp
Colour: White
Colour/glass: Transparent
Material: Cast aluminum
Material/dome: Polycarbonate
Shape: Round
No./LEDs: 6
Tightness norm: IP 67
Approvals: EMC/ADR/GGVS

171776 LED Interior Lamp

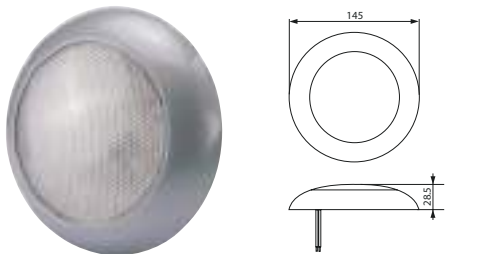

Voltage: 12/24

Dim.: 145x28.5 mm
Cable length: 220 mm
Dist. mount. holes:
123 mm

Type: LED
Colour: Silver
Colour/glass: Frosted
Material: Shockproof plastic
Material/dome: Shockproof plastic
Shape: Circular
Mount.: Plan installation
No./LEDs: 42
Tightness norm: IP 66
Approvals: CE

171825 LED Interior Lamp



Voltage: 24
Watt: 2.2
Kelvin: 6500
Lumen: 80

Dim.: 300x15.2x6 mm
Cable length: 400 mm

Type: LED
Colour: Grey
Colour/glass: Transparent
Material: Aluminium
Material/dome: Polycarbonate
Shape: Flat
Mount.: Plan installation
Bracket: Snap-on
Fixing screw: w/
No./LEDs: 12
Tightness norm: IP 65
Approvals: CE

171826 LED Interior Lamp

Voltage: 24
Watt: 4.3
Kelvin: 6500
Lumen: 160

Dim.: 600x15.2x6 mm
Cable length: 400 mm

Type: LED
Colour: Grey
Colour/glass: Transparent
Material: Aluminium
Material/dome: Polycarbonate
Shape: Flat
Mount.: Plan installation
Bracket: Snap-on
Fixing screw: w/
No./LEDs: 24
Tightness norm: IP 65
Approvals: CE

171827 LED Interior Lamp

Voltage: 24
Watt: 7.5
Kelvin: 6500
Lumen: 281

Dim.: 1000x15.2x6 mm
Cable length: 400 mm

Type: LED
Colour: Grey
Colour/glass: Transparent
Material: Aluminium
Material/dome: Polycarbonate
Shape: Flat
Mount.: Plan installation
Bracket: Snap-on
Fixing screw: w/
No./LEDs: 42
Tightness norm: IP 65
Approvals: CE

171828 LED Interior Lamp

Voltage: 24
Watt: 10.8
Kelvin: 6500
Lumen: 394

Dim.: 1400x15.2x6 mm
Cable length: 400 mm

Type: LED
Colour: Grey
Colour/glass: Transparent
Material: Aluminium
Material/dome: Polycarbonate
Shape: Flat
Mount.: Plan installation
Bracket: Snap-on
Fixing screw: w/
No./LEDs: 60
Tightness norm: IP 65
Approvals: CE

171829 LED Interior Lamp

Voltage: 12
Watt: 2.2
Kelvin: 6500
Lumen: 80

Dim.: 300x15.2x6 mm
Cable length: 400 mm

Type: LED
Colour: Grey
Colour/glass: Transparent
Material: Aluminium
Material/dome: Polycarbonate
Shape: Flat
Mount.: Plan installation
Bracket: Snap-on
Fixing screw: w/
No./LEDs: 12
Tightness norm: IP 65
Approvals: CE

171830 LED Interior Lamp

Voltage: 12
Watt: 4.3
Kelvin: 6500
Lumen: 160

Dim.: 600x15.2x6 mm
Cable length: 400 mm

Type: LED
Colour: Grey
Colour/glass: Transparent
Material: Aluminium
Material/dome: Polycarbonate
Shape: Flat
Mount.: Plan installation
Bracket: Snap-on
Fixing screw: w/
No./LEDs: 24
Tightness norm: IP 65
Approvals: CE

171831 LED Interior Lamp

Voltage: 12
Watt: 7.5
Kelvin: 6500
Lumen: 281

Dim.: 1000x15.2x6 mm
Cable length: 400 mm

Type: LED
Colour: Grey
Colour/glass: Transparent
Material: Aluminium
Material/dome: Polycarbonate
Shape: Flat
Mount.: Plan installation
Bracket: Snap-on
Fixing screw: w/
No./LEDs: 42
Tightness norm: IP 65
Approvals: CE

171832 LED Interior Lamp



Voltage: 12
Watt: 10.8
Kelvin: 6500
Lumen: 394

Dim.: 1400x15.2x6 mm
Cable length: 400 mm

Type: LED
Colour: Grey
Colour/glass: Transparent
Material: Aluminium
Material/dome: Polycarbonate
Shape: Flat
Mount.: Plan installation
Bracket: Snap-on
Fixing screw: w/
No./LEDs: 60
Tightness norm: IP 65
Approvals: CE

171863 LED Interior Lamp

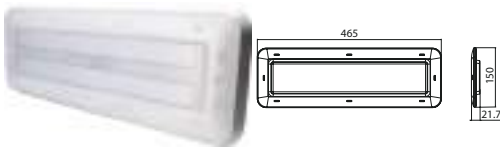

Voltage: 12/24
Watt: 22
Lumen: 1100

Dim.: 465x150x21.7 mm
Cable length: 420 mm

Type: LED
Colour: White
Colour/glass: Frosted
Material: Shockproof plastic
Material/dome: PMMA
Shape: Rectangular
Mount.: Built-in
No./LEDs: 12
Tightness norm: IP 67
Approvals: CE

171864 LED Interior Lamp

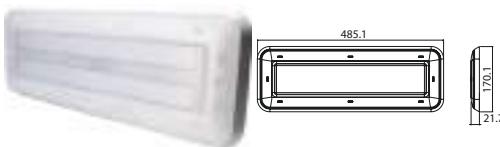

Voltage: 12/24
Watt: 22
Lumen: 1100

Dim.: 485.1x170.1x21.7 mm
Cable length: 420 mm

Type: LED
Colour: White
Colour/glass: Frosted
Material: Shockproof plastic
Material/dome: PMMA
Shape: Rectangular
Mount.: Plan installation
No./LEDs: 12
Tightness norm: IP 67
Approvals: CE

171866 LED Interior Lamp

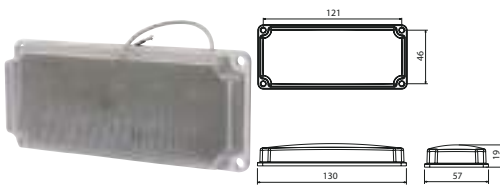

Voltage: 12/24
Lumen: 210

Dim.: 130x57x19 mm
Cable length: 150 mm
Dist. mount. holes: 46x121 mm

Type: LED
Colour: Transparent
Colour/glass: Frosted
Material: Shockproof plastic
Material/dome: PMMA
Shape: Rectangular
Mount.: Plan installation
Fixing screw: 4
No./LEDs: 10
Tightness norm: IP 67
Approvals: CE

171874 LED Interior Lamp



Voltage: 10-33
Watt: 1.6-3.4
Lumen: 82

Dim.: 300x19x19 mm
Cable length: 400 mm

Type: LED
Colour: Grey
Colour/glass: Transparent
Material: Aluminium
Material/dome: Polycarbonate
Shape: Angled
Mount.: Plan installation
Bracket: Snap-on
No./LEDs: 12
Tightness norm: IP 65
Approvals: CE

171875 LED Interior Lamp



Voltage: 10-30
Watt: 3.2-6.8
Lumen: 166

Dim.: 600x19x19 mm
Cable length: 400 mm

Type: LED
Colour: Grey
Colour/glass: Transparent
Material: Aluminium
Material/dome: Polycarbonate
Shape: Angled
Mount.: Plan installation
Bracket: Snap-on
No./LEDs: 24
Tightness norm: IP 65
Approvals: CE

171876 LED Interior Lamp



Voltage: 10-30
Watt: 5.7-11.8
Lumen: 273

Dim.: 1000x19x19 mm
Cable length: 400 mm

Type: LED
Colour: Grey
Colour/glass: Transparent
Material: Aluminium
Material/dome: Polycarbonate
Shape: Angled
Mount.: Plan installation
Bracket: Snap-on
No./LEDs: 42
Tightness norm: IP 65
Approvals: CE

171877 LED Interior Lamp



Voltage: 10-30
Watt: 8.1-16.8
Lumen: 383

Dim.: 1400x19x19 mm
Cable length: 400 mm

Type: LED
Colour: Grey
Colour/glass: Transparent
Material: Aluminium
Material/dome: Polycarbonate
Shape: Angled
Mount.: Plan installation
Bracket: Snap-on
No./LEDs: 60
Tightness norm: IP 65
Approvals: CE

INTERIOR LAMPS FLOURESCENT

RESOLUX 505

170036 Interior Lamp

Tube fluorescent: HC-CARGO 170664.

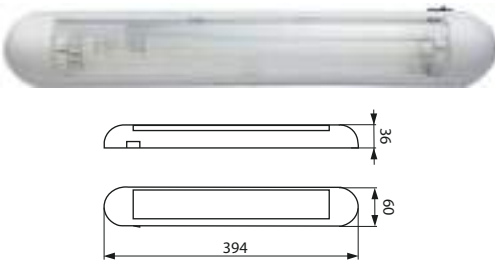

Voltage: 24
Watt: 8

Dim.: 394x60x36 mm
Dist. mount. holes:
350 mm

Colour: White
Material: ABS plastic
Shape: Oblong
Switch: w/
Fixing screw: 2
Tightness norm: IP 40
Approvals: CE

RESOLUX 720

170033 Interior Lamp

Tube fluorescent: HC-CARGO 171397.

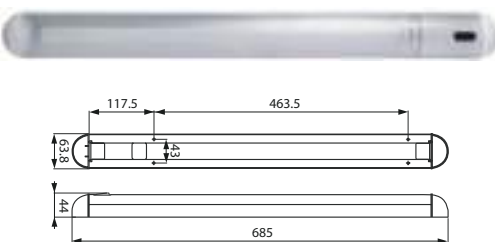

Voltage: 24
Watt: 13

Dim.: 685x63.8x44 mm
Dist. mount. holes:
590 mm

Colour: White
Material: ABS plastic/aluminium
Shape: Oblong
Switch: w/
Fixing screw: 2
Tightness norm: IP 40
Approvals: CE

SLIM STYLING

171396 Interior Lamp

Tube fluorescent: HC-CARGO 171397.



Voltage: 24
Watt: 13

Dim.: 580x50x26 mm
Dist. mount. holes:
465 mm

Colour: White
Material: Plastic
Shape: Rectangular
Switch: w/
Fixing screw: 2

SPARE PARTS
170664 Neon tube

Servicing: HC-CARGO 170035, 170036, 171393, 200181

 Voltage: 12-24
Watt: 8

Length: 300 mm

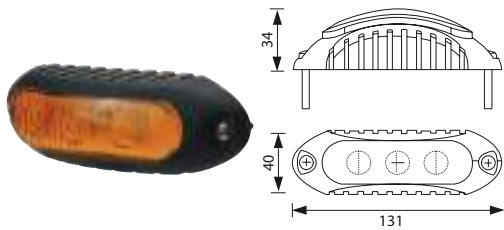
SIDE MARKER LAMPS LED
171618 LED Side Marker Lamp

Voltage: 9-36

 Dim.: 131x40x34 mm
Cable length: 28 mm
Dist. mount. holes:
115 mm

 Type: LED
Colour: Yellow
Colour/glass: Orange
Material: PP/PMMA
Material/dome: ABS plastic
Mount.: Screw fastening
No./lamps: 1
Fixing screw: 2
Sidemarker lamp: w/
No./LEDs: 3
Wiring system: w/
E-approval: Yes

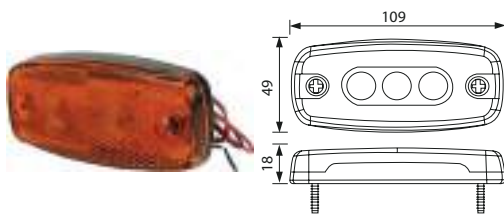
171636 LED Side Marker Lamp

 Voltage: 9-36
Watt: 0.9

 Dim.: 109x49x18 mm
Dist. mount. holes:
83 mm

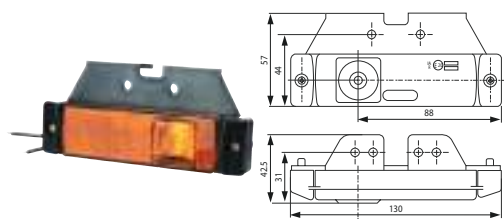
 Type: LED
Colour/glass: Orange
Shape: Rectangular
Reflector: w/
Sidemarker lamp: w/
No./LEDs: 3
E-approval: Yes

171721 LED Side Marker Lamp

Voltage: 12/24

 Dim.: 130x57x42.5 mm
Dist. mount. holes:
50 mm

 Type: LED
Socket type: LED
Material: Shockproof plastic
Shape: Rectangular
Bracket: Angled
Reflector: w/
Sidemarker lamp: w/
No./LEDs: 1
E-approval: Yes

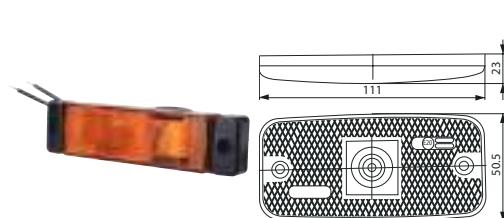
171722 LED Side Marker Lamp

Voltage: 12/24

 Dim.: 111x50.5x23 mm
Dist. mount. holes:
116 mm

 Type: LED
Socket type: LED
Colour/glass: Orange
Material: Shockproof plastic
Shape: Rectangular
Mount.: Flat w/ 2 fixing holes
Reflector: w/
Fixing screw: 2
Sidemarker lamp: w/
No./LEDs: 1
E-approval: Yes

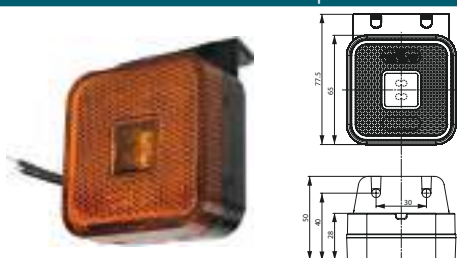
171729 LED Side Marker Lamp

Servicing: MAN

 Voltage: 12/24
Watt: 1

 Dim.: 65x65x28 mm
Dist. mount. holes:
30 mm

 Type: LED
Colour/glass: Orange
Material: ABS plastic
Material/dome: PMMA
Shape: Square
Bracket: Angled
Reflector: w/
Sidemarker lamp: w/
No./LEDs: 2
E-approval: Yes

171736 LED Side Marker Lamp

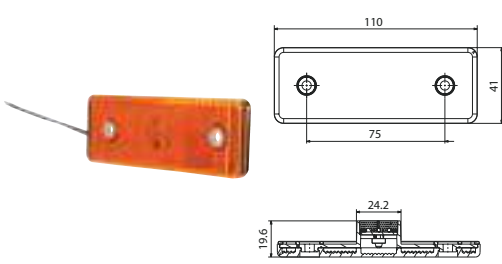

Voltage: 24

Dim.: 110x41x19.6 mm
Cable length: 20 mm
Dist. mount. holes:
75 mm

Type: LED
Shape: Rectangular
Sidemarker lamp: w/
No./LEDs: 1
E-approval: Yes

171742 LED Side Marker Lamp

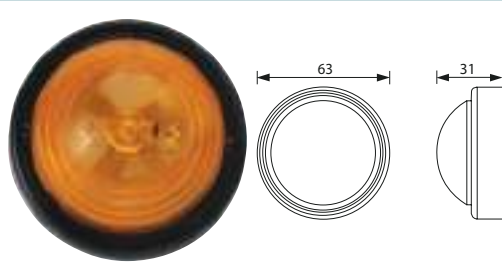

Voltage: 12/24

Dim.: 63x31 mm
OD: 63 mm
Cable length: 300 mm

Type: LED
Colour: Black
Colour/glass: Orange
Material: PVC
Material/dome: PMMA
Mount.: 2 screws
Sidemarker lamp: w/
No./LEDs: 3
Approvals: ADR/SAE
E-approval: Yes

171835 LED Adapter

Servicing: HC-CARGO 171836, 193119

HC-CARGO 171835 is the LED version of HC-CARGO 170763.



Voltage: 12/24

171839 LED Side Marker Lamp

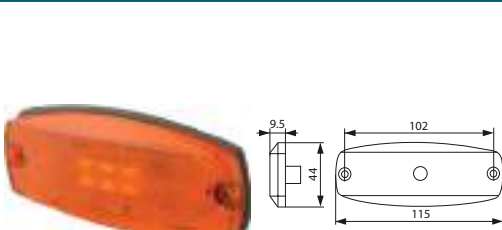

Voltage: 12/24
Watt: 0.45-1.6

Dim.: 115x44x9.5 mm
Cable length: 5000 mm
Dist. mount. holes:
102 mm

Type: LED
Colour: White
Colour/glass: Orange
Material: Polycarbonate
Material/dome: Polycarbonate
Shape: Rectangular
Mount.: 2 screws
Reflector: w/
Sidemarker lamp: w/
No./LEDs: 3
Tightness norm: IP 67
Approvals: SAE
E-approval: Yes

171842 LED Side Marker Lamp

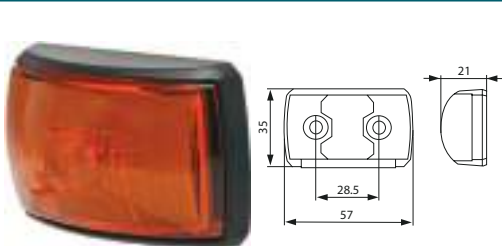

Voltage: 12/24

Dim.: 57x35x21 mm
Cable length: 400 mm
Dist. mount. holes:
28.5 mm

Type: LED
Colour: Black
Colour/glass: Orange
Material: ASA plastic
Material/dome: PMMA
Shape: Rectangular
Fixing screw: 2
Sidemarker lamp: w/
No./LEDs: 2
Tightness norm: IP 67
E-approval: Yes

171860 LED Side Marker Lamp





Voltage: 12/24
Watt: 0.3-0.6

Dim.: 72x26x24 mm
Cable length: 5000 mm
Dist. mount. holes:
61 mm

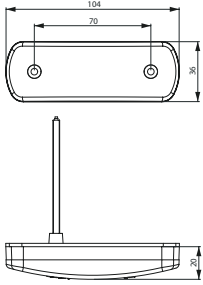
Type: LED
Colour: Black
Colour/glass: Orange
Material: PP
Material/dome: PMMA
Shape: Rectangular
Fixing screw: 2
Sidemarker: w/
No./LEDs: 3
Approvals: CE
E-approval: Yes

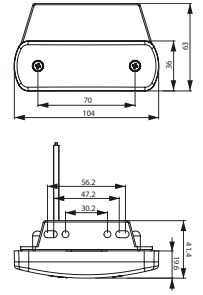
172036 LED Side Marker Lamp			
		Voltage: 12/24 Dim.: 104x36x20 mm Cable length: 500 mm Dist. mount. holes: 70 mm	Type: LED Colour/glass: Orange Material: Shockproof plastic Shape: Rectangular Reflector: w/ Fixing screw: 2 Sidemarkers lamp: w/ No./LEDs: 1 E-approval: Yes

172037 LED Side Marker Lamp			
		Voltage: 12/24 Dim.: 104x36x19.6 mm Cable length: 500 mm Dist. mount. holes: 70 mm	Type: LED Colour/glass: Orange Material: Shockproof plastic Shape: Rectangular Bracket: Angled Reflector: w/ Fixing screw: 2 Sidemarkers lamp: w/ No./LEDs: 1 E-approval: Yes

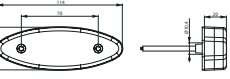
172041 LED Side Marker Lamp			
		Voltage: 12/24 Dim.: 114x39x20 mm Cable length: 500 mm Dist. mount. holes: 70 mm	Type: LED Colour/glass: Orange Material: Shockproof plastic Reflector: w/ Fixing screw: 2 Sidemarkers lamp: w/ No./LEDs: 1 E-approval: Yes

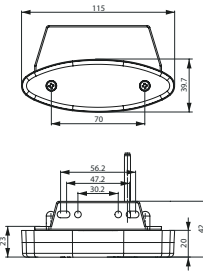
172042 LED Side Marker Lamp			
		Voltage: 12/24 Dim.: 115x39.7x20 mm Dist. mount. holes: 70 mm	Type: LED Colour/glass: Orange Material: Shockproof plastic Shape: Oval Bracket: Angled Reflector: w/ Fixing screw: 2 Sidemarkers lamp: w/ No./LEDs: 1 E-approval: Yes

ACCESSORIES

171639 Angle Bracket			
	Servicing: HC-CARGO 171636, 171637, 171638		

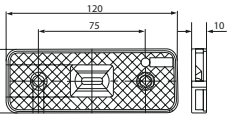
171836 Lens			
		Dim.: 120x44.7x10 mm	Shape: Square E-approval: Yes

193119 Junior Power Timer Connector

Servicing: HC-CARGO 171835, 171836

Terminal: HC-CARGO 192175, 192176, 192177, 192178, 192179.

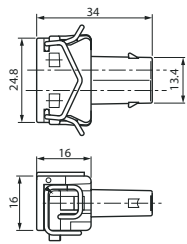

Type/terminal: Junior Power Timer
 Colour: Black
 No./poles: 2
 Plug: Female

SIDE MARKER LAMPS CONVENTIONAL
170880 Side Marker Lamp

Lens: HC-CARGO 170975.

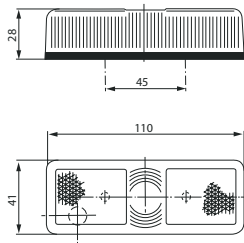

Bulb incl.: No
 Watt: 5

Dim.: 110x41x28 mm
 Dist. mount. holes:
 45 mm

Socket type: S8.5
 Colour: Black
 Colour/glass: Orange
 Material: Shockproof plastic
 Shape: Rectangular
 Reflector: w/
 Fixing screw: 2
 E-approval: Yes

170884 Side Marker Lamp

Lens: HC-CARGO 170946.

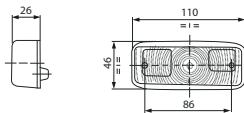

Bulb incl.: No
 Watt: 5

Dim.: 110x46x26 mm
 Dist. mount. holes:
 85 mm

Socket type: T10
 Colour/glass: Orange
 Material: Shockproof plastic
 Shape: Rectangular
 Reflector: w/
 Fixing screw: 2
 E-approval: Yes

170885 Side Marker Lamp

Lens: HC-CARGO 170946.

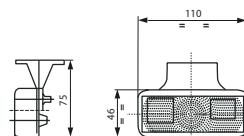

Bulb incl.: No
 Watt: 5

Dim.: 110x46x26 mm
 Dist. mount. holes:
 20/50 mm

Socket type: T10
 Colour/glass: Orange
 Material: Shockproof plastic
 Shape: Rectangular
 Bracket: Angled
 Reflector: w/
 E-approval: Yes

171175 Side Marker Lamp

Lens: HC-CARGO 171243.

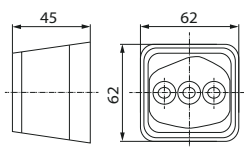

Bulb incl.: No
 Watt: 5

Dim.: 62x62x45 mm
 Dist. mount. holes:
 30 mm

Socket type: S8.5
 Colour: Black
 Colour/glass: Orange
 Material: Shockproof plastic
 Reflector: w/
 Fixing screw: 2
 E-approval: Yes

171369 Side Marker Lamp

Lens: HC-CARGO 171243.

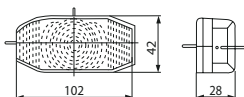

Bulb incl.: No
 Watt: 5

Dim.: 102x42x28 mm
 Dist. mount. holes:
 65 mm

Socket type: S8.5
 Colour: Black
 Colour/glass: Orange
 Material: Plastic
 Fixing screw: 2
 E-approval: Yes

SPARE PARTS
170946 Lens

Servicing: HC-CARGO 170885



Dim.: 110x46 mm

170975 Lens

Servicing: HC-CARGO 170880

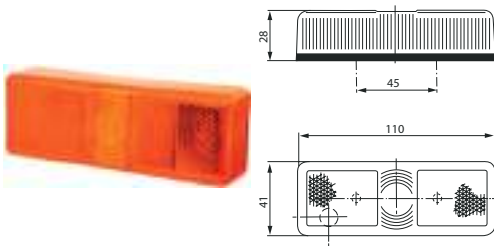

Dim.: 110x41x28 mm

SIDE INDICATORS CONVENTIONAL
170713 Side Indicator

Lens: HC-CARGO 170670, 170671.



 Bulb incl.: No
Watt: 5

 Dim.: 108x84x93 mm
OD: 60 mm

 Socket type: BA15S
Colour/glass: Orange
E-approval: Yes

171183 Side Indicator

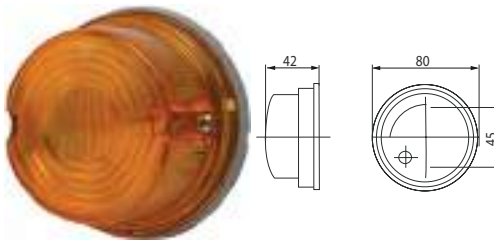
Lens: HC-CARGO 171247.

 Bulb incl.: No
Watt: 5

 Dim.: 80x42 mm
Dist. mount. holes:
45 mm

 Socket type: S8.5
Colour/glass: Orange
Material: Shockproof plastic
Fixing screw: 2
E-approval: Yes

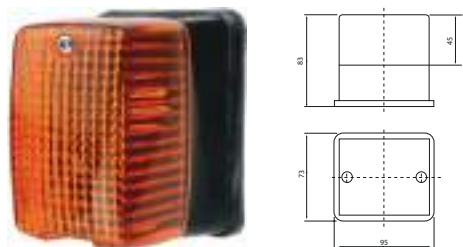
171337 Side Indicator

 Bulb incl.: No
Watt: 10

 Dim.: 95x73x83 mm
Dist. mount. holes:
48 mm

 Socket type: BA15S
Colour: Black
Colour/glass: Orange
Material: Plastic
Shape: Rectangular
Fixing screw: 2
E-approval: Yes

171339 Side Indicator

Lens: HC-CARGO 171340.

 Bulb incl.: No
Watt: 21

 Dim.: 84x84x51 mm
Dist. mount. holes:
45 mm

 Socket type: BA15S
Colour/glass: Orange
Material: Plastic
Shape: Rectangular
Fixing screw: 2
E-approval: Yes

SPARE PARTS
170670 Lens

Servicing: HC-CARGO 170713



 Colour/glass: Orange
 Material: Glass

170671 Bulb Holder

Servicing: HC-CARGO 170640, 170668, 170713

SIDE INDICATORS LED
171770 LED Flasher Lamp

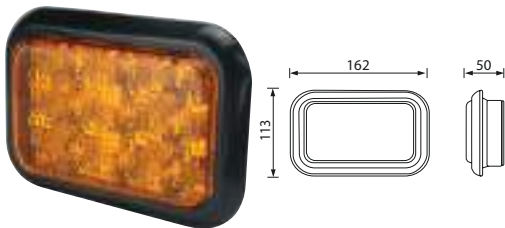
Servicing: Fiat, Kia, MAN



 Voltage: 24
 Watt: 4

Dim.: 162x113x50 mm

 Type: Flasher lamp
 Colour/glass: Orange
 Material: ABS plastic
 Material/dome: PMMA
 Shape: Rectangular
 Mount.: Plan installation
 Flasher light: w/
 No./LEDs: 16
 RH/LH: RH/LH
 E-approval: Yes

FORWARD LIGHTING
DRIVING LAMP CONVENTIONAL
170550 Driving Lamp

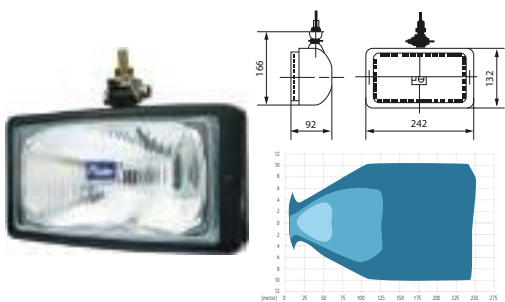
Light unit: HC-CARGO 170621.

 Bulb incl.: No
 Watt: 55/70
 Watt 2: 70

 Dim.: 242x166x92 mm
 Light aperture:
 200x107 mm

 Type: Driving lamp
 Bulb type: H3
 Bulb type 2: H3
 Socket type: PK22s
 Socket type 2: PK22s
 Colour: Black
 Material: Metal
 Material/dome: Glass
 Shape: Rectangular
 Mount.: Mounted below
 E-approval: Yes

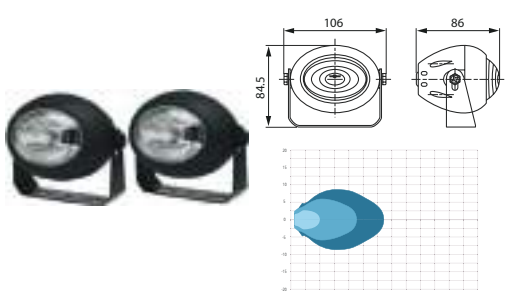
171359 Driving Lamp

 Bulb incl.: No
 Watt: 55
 Watt 2: 70

 Dim.: 106x84.5x86 mm
 Light aperture:
 55x35 mm

 Type: Driving lamp
 Bulb type: H3
 Bulb type 2: H3
 Socket type: PK22s
 Socket type 2: PK22s
 Material: Shockproof plastic
 Material/dome: Glass
 Shape: Oval
 Mount.: U-bracket w/ 2 holes
 Asymmetric light: w/o
 E-approval: No

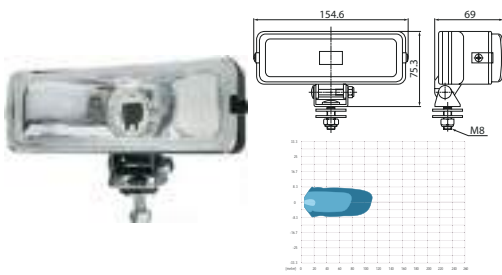
171361 Driving Lamp



Bulb incl.: No
Watt: 55
Watt 2: 70

Dim.: 154.6x75.3x69 mm
Light aperture: 130x35 mm

Type: Driving lamp
Bulb type: H3
Bulb type 2: H3
Socket type: PK22s
Socket type 2: PK22s
Material: Shockproof plastic
Material/dome: Glass
Shape: Rectangular
Mount.: U-bracket w/ 1 bolt
E-approval: No

171363 Driving Lamp

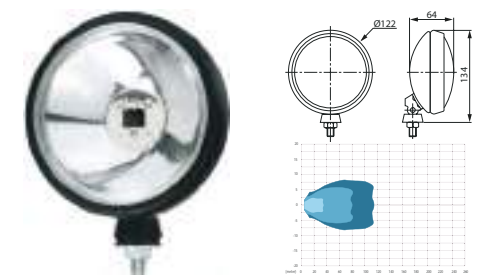

Bulb incl.: No
Voltage: 12/24
Watt: 55
Watt 2: 70

Dim.: 122x134x64 mm
Light aperture: 95 mm

Type: Driving lamp
Bulb type: H3
Bulb type 2: H3
Socket type: PK22s
Socket type 2: PK22s
Colour: Black
Material: Metal
Material/dome: Glass
Shape: Round
Mount.: Mounted below
E-approval: No

171365 Driving Lamp

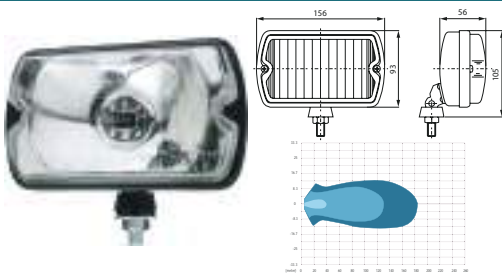

Bulb incl.: No
Watt: 55
Watt 2: 70

Dim.: 156x105x56 mm
Light aperture: 110x75 mm

Type: Driving lamp
Bulb type: H3
Bulb type 2: H3
Socket type: PK22s
Socket type 2: PK22s
Colour: Black
Material: Metal
Material/dome: Glass
Shape: Rectangular
Mount.: Mounted below
E-approval: Yes

171597 Driving Lamp

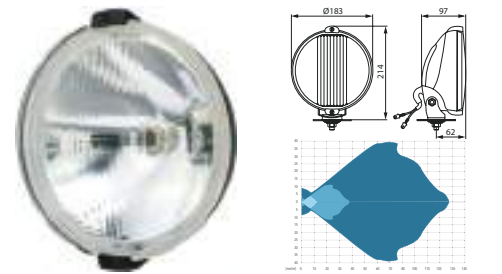

Bulb incl.: No
Watt: 55/70
Watt 2: 4

Dim.: 183x214x97 mm
Light aperture: 180 mm

Type: Driving lamp
Bulb type: H3
Socket type: PK22s
Socket type 2: BA9s
Colour: Black
Material: Metal
Material/dome: Glass
Shape: Round
Mount.: Mounted below
Sidemarker: w/
E-approval: Yes

SPARE PARTS

170621 Light Unit

Servicing: HC-CARGO 170550

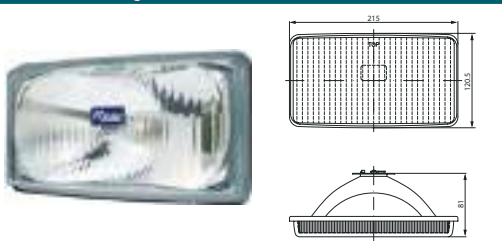

Bulb incl.: No
Watt: 55
Watt 2: 70

Dim.: 215x120.5x81 mm
Light aperture: 200x107 mm

Bulb type: H3
Bulb type 2: H3
Socket type: PK22s
Socket type 2: PK22s
Colour: Black
Material: Metal
Material/dome: Glass
Shape: Rectangular
Asymmetric light: w/o
E-approval: Yes

DRIVING LAMP LED

172059 LED Driving Lamp

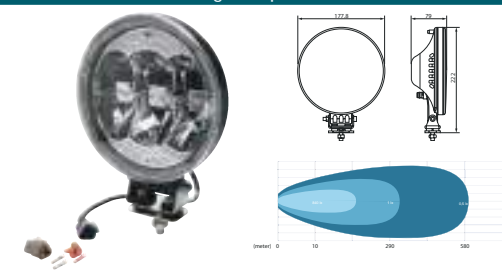

Voltage: 10-30
Watt: 60
Kelvin: 6000
Lumen: 5400

Dim.: 222x177.8x79 mm

Type: LED Driving lamp
Material: Cast aluminum
Material/dome: Polycarbonate
Shape: Round
Sidemarker: w/
Tightness norm: IP 67
Approvals: CE
E-approval: Yes

172060 LED Driving Lamp

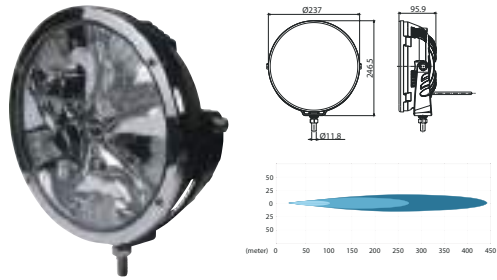

Voltage: 9-36
Watt: 18
Lumen: 4500

Dim.: 246.5x237x95.9 mm
Cable length: 300 mm

Type: LED Driving lamp
Material: Aluminium
Material/dome: Polycarbonate
Shape: Round
Sidemarker: w/
Tightness norm: IP 69K
Approvals: CE
E-approval: Yes

172092 LED Driving Light Bar

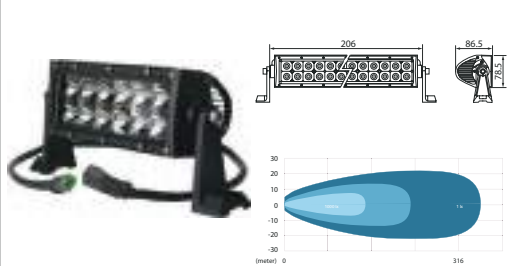

Voltage: 10-30
Amp: 2.2/1.2
Watt: 36
Kelvin: 6000
Lumen: 3240

Dim.: 206x86.5x78.5 mm
Cable length: 500 mm

Bulb type: 12 LED
Colour: Black
Material/dome: Polycarbonate
Material/house: Cast aluminum
Shape: Straight
Mount. bracket: Vertical
2 poles: Male/female
Tightness norm: IP 69K
Approvals: ECE R112
E-approval: Yes

172093 LED Driving Light Bar

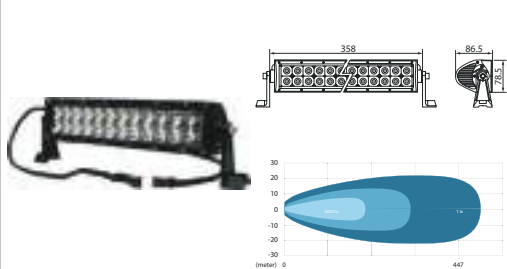

Voltage: 10-30
Amp: 4.2/2.2
Watt: 72
Kelvin: 6000
Lumen: 6480

Dim.: 358x86.5x78.5 mm
Cable length: 500 mm

Bulb type: 24 LED
Colour: Black
Material/dome: Polycarbonate
Material/house: Cast aluminum
Shape: Straight
Mount. bracket: Vertical
2 poles: Male/female
Tightness norm: IP 69K
Approvals: ECE R112
E-approval: Yes

172102 LED Driving Light Bar

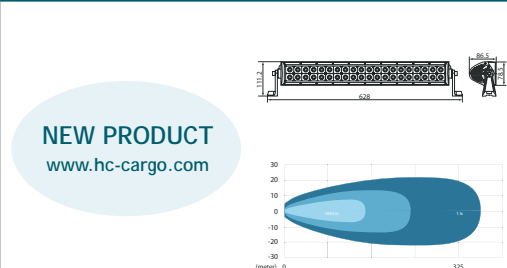

NEW PRODUCT
www.hc-cargo.com

Voltage: 10-30
Amp: 6.6/3.4
Watt: 120
Kelvin: 6000
Lumen: 10800

Cable length: 500 mm

Bulb type: 40 LED
Colour: Black
Material/dome: Polycarbonate
Material/house: Cast aluminum
Shape: Straight
Mount. bracket: Vertical
2 poles: Male/female
Tightness norm: IP 69K
Approvals: ECE R112
E-approval: Yes

FLASHER-POSITION LAMPS CONVENTIONAL

170925 Flasher/Position Lamp

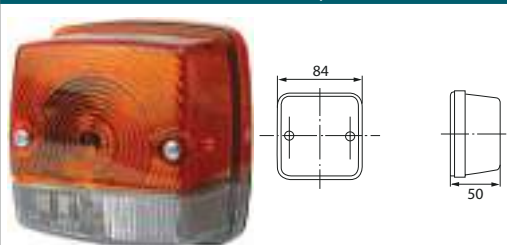

Bulb incl.: No
Watt: 21
Watt 2: 5

Dim.: 84x50 mm
Dist. mount. holes: 45 mm

Socket type: BA15S
Socket type 2: S8.5
Material: Shockproof plastic
Shape: Square
Fixing screw: 2
RH/LH: RH/LH
E-approval: Yes

170927 Flasher/Position Lamp

Lens: HC-CARGO 170989.

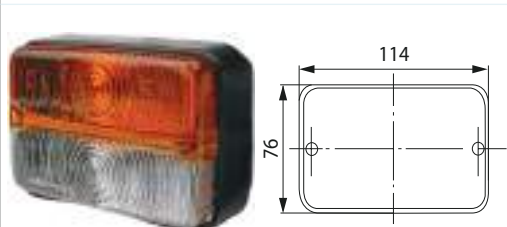

Bulb incl.: No
Watt: 21
Watt 2: 5

Dim.: 114x76 mm
Dist. mount. holes: 58 mm

Socket type: BA15S
Socket type 2: BA15S
Material: Shockproof plastic
Shape: Rectangular
Fixing screw: 2
RH/LH: RH/LH
E-approval: Yes

171215 Flasher/Position Lamp

Lens: HC-CARGO 171248.

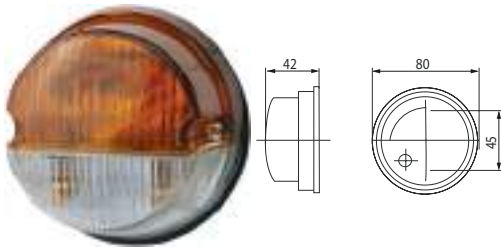

Bulb incl.: No
Watt: 18
Watt 2: 10

Dim.: 80x42 mm
Dist. mount. holes:
45 mm

Socket type: S8.5
Socket type 2: S8.5
Material: Metal
Shape: Circular
Fixing screw: 2
RH/LH: RH/LH
E-approval: Yes

171217 Flasher/Position Lamp

Right: HC-CARGO 171260.

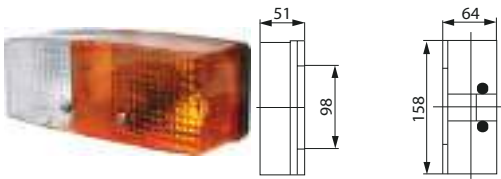

Bulb incl.: No
Watt: 21
Watt 2: 5

Dim.: 158x64x51 mm
Dist. mount. holes:
98/45 mm

Socket type: BA15S
Socket type 2: BA15S
Material: Shockproof plastic
Shape: Rectangular
Fixing screw: 4
RH/LH: LH
E-approval: Yes

171218 Flasher/Position Lamp

Left: HC-CARGO 171217.

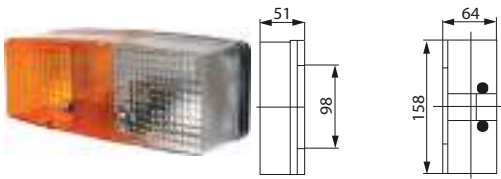

Bulb incl.: No
Watt: 21
Watt 2: 5

Dim.: 158x64x51 mm
Dist. mount. holes:
98/45 mm

Socket type: BA15S
Socket type 2: BA15S
Material: Shockproof plastic
Shape: Rectangular
Fixing screw: 4
RH/LH: RH
E-approval: Yes

171510 Flasher/Position Lamp

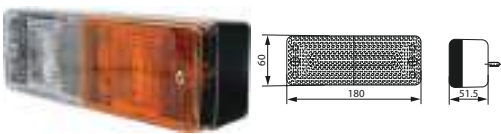

Bulb incl.: No
Watt: 21
Watt 2: 5

Dim.: 180x60x51.5 mm
Dist. mount. holes:
134 mm

Socket type: BA15S
Socket type 2: BA15S
Material: Shockproof plastic
Shape: Rectangular
Fixing screw: 2
RH/LH: RH/LH
E-approval: Yes

SPARE PARTS

170989 Lens

Servicing: HC-CARGO 170927



Dim.: 114x76 mm

Shape: Rectangular

FLASHER-POSITION LAMPS LED

171800 LED Flasher/Positions Lamp

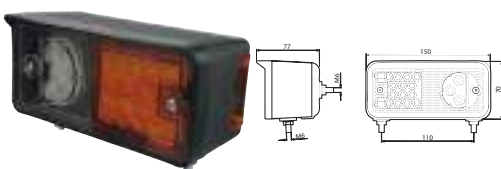

Voltage: 12/24

Dim.: 150x70x77 mm
Cable length: 2100 mm
Dist. mount. holes:
110/55 mm

Colour: Black
Material: Shockproof plastic
Shape: Rectangular
Mount.: Upright/pendant
Fixing screw: 2
No./LEDs: 14/3
RH/LH: LH
E-approval: Yes

171801 LED Flasher/Positions Lamp

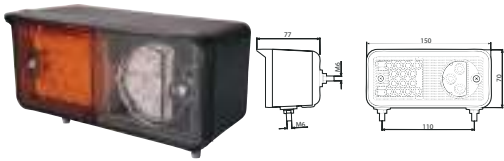

Voltage: 12/24

Dim.: 150x70x77 mm
Cable length: 2100 mm
Dist. mount. holes: 110/55 mm

Colour: Black
Material: Shockproof plastic
Shape: Rectangular
Mount.: Upright/pendant
Fixing screw: 2
No./LEDs: 14/3
RH/LH: RH
E-approval: Yes

HEADLIGHT INSERTS

170867 Head Lamp

Heat resistant plastic reflector bonded w/ glass lens. Flush fitting head lA. Build-in depth: 69 mm.

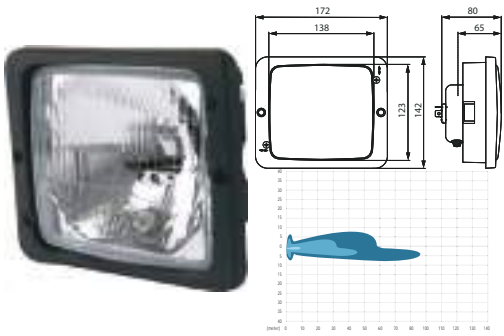

Bulb incl.: No
Watt: 60/55
Watt 2: 75/70
Watt 3: 4

Dim.: 172x142x80 mm

Bulb type: H4
Bulb type 2: H4
Socket type: P43t
Socket type 2: P43t
Socket type 3: BA9s
Material: Metal
Material/dome: Glass
Fixing screw: 2
Sidemarker: w/
E-approval: Yes

170868 Light Unit



Bulb incl.: No
Watt: 60/55
Watt 2: 75/70
Watt 3: 4

Dim.: 163x84 mm
OD: 144 mm
Light aperture: 143 mm

Bulb type: H4
Bulb type 2: H4
Socket type: P43t
Socket type 2: P43t
Socket type 3: BA9s
Material: Rubber
Material/dome: Glass
Shape: Round
Sidemarker: w/
Asymmetric light: w/o
RH/LH: RH/LH
E-approval: Yes

LED DAYTIME RUNNING LIGHT SETS

171739 Daytime Running Light

High beam 5 watt, low beam 0.5 watt.

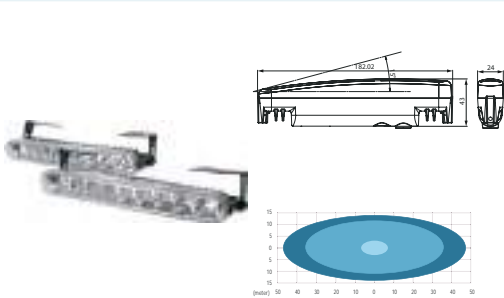

Voltage: 12/24
Watt: 6-5.8

Dim.: 180.02x24x43 mm
Cable length: 500 mm
Dist. mount. holes: 110 mm

Type: LED
Material: ABS plastic
Material/dome: PMMA
Shape: Rectangular
Mount.: Bracket
Bracket: Adjustable
No./lamps: 2
Fixing screw: 4
No./LEDs: 2x18
E-approval: Yes

171740 Daytime Running Light

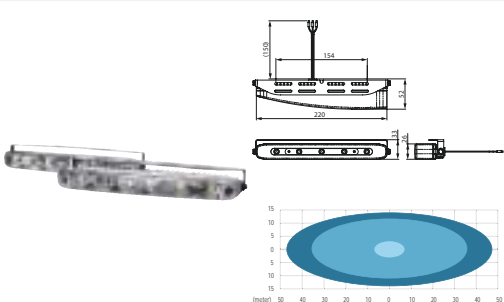

Voltage: 12/24
Watt: 2x5

Dim.: 220x33x26 mm
Cable length: 500 mm
Dist. mount. holes: 215 mm

Type: LED
Material: ABS plastic
Material/dome: PMMA
Shape: Rectangular
Mount.: Bracket
Bracket: Adjustable
No./lamps: 2
Fixing screw: 4
No./LEDs: 2x5
E-approval: Yes

171741 Daytime Running Light

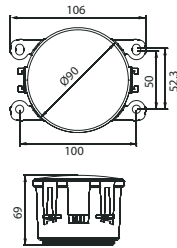

Voltage: 12/24
Watt: 4

Dim.: 90x69 mm
OD: 90 mm
Cable length: 500 mm
Dist. mount. holes: 40 mm
Light aperture: 73 mm

Type: LED
Material: ABS plastic
Material/dome: PMMA
Shape: Round
Mount.: Bracket
Bracket: Adjustable
No./lamps: 2
Fixing screw: 2
No./LEDs: 2x18
E-approval: Yes

POSITION LAMPS CONVENTIONAL

170875 Position Lamp

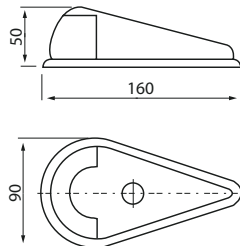

Bulb incl.: No
Voltage: 12/24
Watt: 5

Dim.: 160x59x45 mm
Dist. mount. holes: 57 mm

Colour/glass: White
Material: Plastic
Fixing screw: 2

170881 Position Lamp

Lens: HC-CARGO 170976.

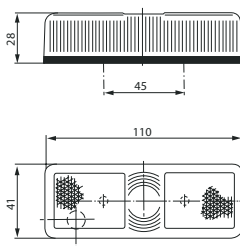

Bulb incl.: No
Watt: 5

Dim.: 110x41x28 mm
Dist. mount. holes: 45 mm

Socket type: S8.5
Colour/glass: White
Material: Shockproof plastic
Shape: Rectangular
Reflector: w/
Fixing screw: 2
Sidemarker lamp: w/
Tail light: w/
E-approval: Yes

170887 Position Lamp

Lens: HC-CARGO 170952.

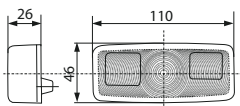

Bulb incl.: No
Watt: 5

Dim.: 110x46x26 mm
Dist. mount. holes: 85 mm

Socket type: T10
Colour/glass: White
Material: Shockproof plastic
Shape: Rectangular
Reflector: w/
Fixing screw: 2
Sidemarker lamp: w/
Tail light: w/
E-approval: Yes

171171 Position Lamp

Lens: HC-CARGO 171238.

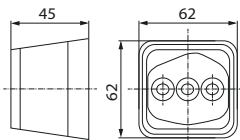

Bulb incl.: No
Watt: 5

Dim.: 62x62x45 mm
Dist. mount. holes: 30 mm

Socket type: S8.5
Colour: Black
Colour/glass: Transparent
Material: Shockproof plastic
Fixing screw: 2
E-approval: Yes

171174 Position Lamp

Lens: HC-CARGO 171242.

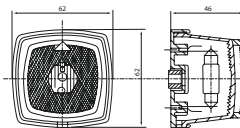

Bulb incl.: No
Watt: 5

Dim.: 62x62x46 mm
Dist. mount. holes: 30 mm

Socket type: S8.5
Colour: Black
Colour/glass: White
Material: Shockproof plastic
Shape: Square
Reflector: w/
Fixing screw: 2
E-approval: Yes

171182 Position Lamp

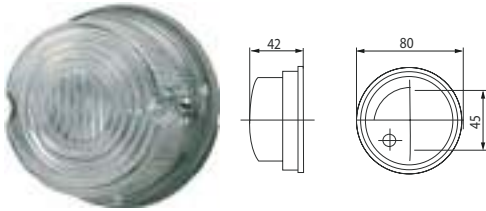

Bulb incl.: No
Watt: 5

Dim.: 80x42 mm
Dist. mount. holes:
45 mm

Type: Position lamp
Socket type: S8.5
Colour/glass: White
Material: Shockproof plastic
Shape: Circular
Fixing screw: 2
E-approval: Yes

171332 Position Lamp

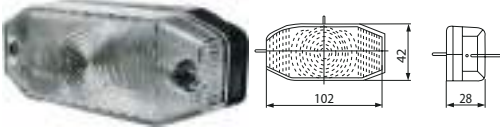

Bulb incl.: No
Watt: 5

Dim.: 102x42x28 mm
Dist. mount. holes:
65 mm

Socket type: S8.5
Colour: Black
Colour/glass: White
Material: Plastic
Fixing screw: 2
E-approval: Yes

SPARE PARTS

170952 Lens

Servicing: HC-CARGO 170887



Dim.: 110x46x26 mm

170976 Lens

Servicing: HC-CARGO 170881

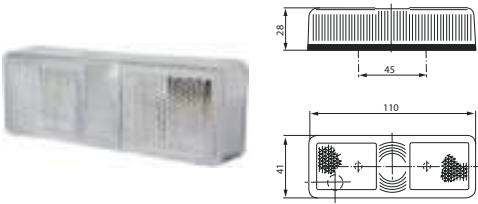

Dim.: 110x41x28 mm

Shape: Rectangular

171242 Lens

Servicing: HC-CARGO 171174



Dim.: 62x62x46 mm

Shape: Square

POSITION LAMPS LED

171603 LED Position Lamp

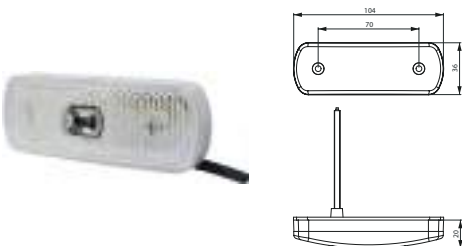

Voltage: 24
Watt: 1.02

Dim.: 104x36x20 mm
Cable length: 500 mm
Dist. mount. holes:
70 mm

Type: LED
Colour/glass: White
Material: Shockproof plastic
Shape: Rectangular
Reflector: w/
Fixing screw: 2
Sidemarker: w/
No./LEDs: 1
Approvals: ADR
E-approval: Yes

171610 LED Position Lamp

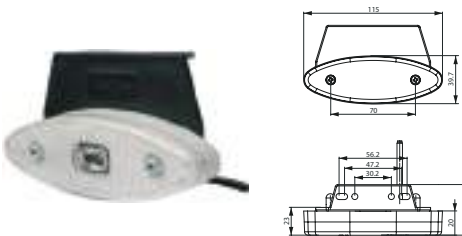

Voltage: 24
Watt: 0.44

Dim.: 115x39.7x20 mm
Cable length: 500 mm
Dist. mount. holes:
52 mm

Type: LED
Colour/glass: White
Material: Shockproof plastic
Shape: Oval
Bracket: Angled
Reflector: w/
Fixing screw: 2
Sidemarker: w/
No./LEDs: 1
E-approval: Yes

171638 LED Position Lamp

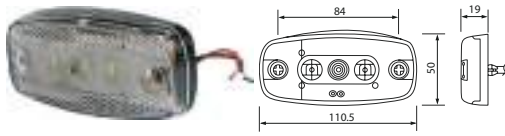

Voltage: 9-36
Watt: 0.9

Dist. mount. holes:
83 mm

Type: LED
Colour/glass: White
Reflector: w/
Sidemarker: w/
No./LEDs: 3
Approvals: ADR
E-approval: Yes

171717 LED Position Lamp

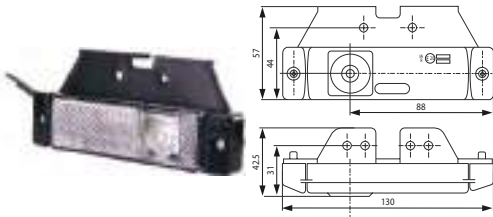

Voltage: 12/24
Watt: 0.4/0.8

Dim.: 130x57x42.5 mm

Type: LED
Socket type: LED
Colour/glass: White
Material: Shockproof plastic
Bracket: Angled
Reflector: w/
Sidemarker: w/
No./LEDs: 1
E-approval: Yes

171718 LED Position Lamp

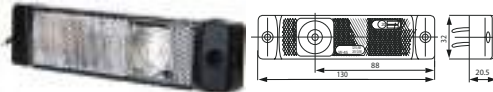

Voltage: 12/24
Watt: 0.4/0.8

Dim.: 130x32x20.5 mm

Type: LED
Socket type: LED
Colour/glass: White
Material: Shockproof plastic
Reflector: w/
Sidemarker: w/
No./LEDs: 1
E-approval: Yes

171744 LED Position Lamp

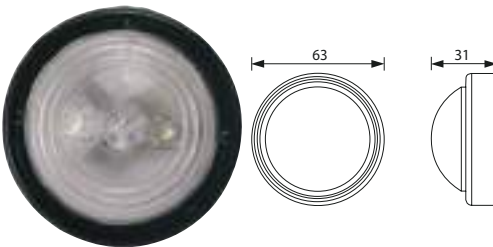

Voltage: 9-36

Dim.: 63x31 mm
OD: 63 mm
Cable length: 300 mm
Dist. mount. holes:
30 mm

Type: LED
Colour: Black
Colour/glass: Transparent
Material: PVC
Material/dome: PMMA
Shape: Round
Mount.: 2 screws
Sidemarker: w/
No./LEDs: 3
Approvals: ADR/SAE
E-approval: Yes

171841 LED Position Lamp

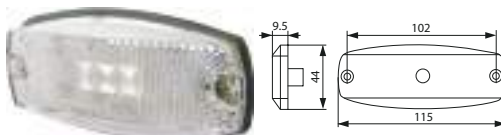

Voltage: 12/24
Watt: 0.45-1.6

Dim.: 115x44x9.5 mm
Cable length: 5000 mm
Dist. mount. holes:
102 mm

Type: LED
Colour: White
Colour/glass: White
Material: Polycarbonate
Material/dome: Polycarbonate
Shape: Rectangular
Mount.: 2 screws
Reflector: w/
Sidemarker: w/
No./LEDs: 3
Tightness norm: IP 67
Approvals: SAE
E-approval: Yes

171844 LED Position Lamp

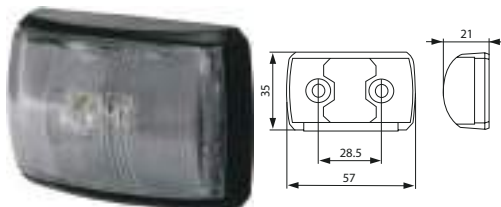

Voltage: 12/24

Dim.: 57x35x21 mm
Cable length: 400 mm
Dist. mount. holes:
28 mm

Type: LED
Colour: Black
Colour/glass: White
Shape: Rectangular
Fixing screw: 2
Sidemarker: w/
No./LEDs: 2
Tightness norm: IP 67
E-approval: Yes

171862 LED Position Lamp

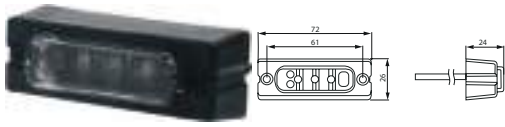

Voltage: 12/24
Watt: 0.3-0.6

Dim.: 72x26x24 mm
Cable length: 5000 mm
Dist. mount. holes:
61 mm

Type: LED
Colour: Black
Colour/glass: White
Material: PP
Material/dome: PMMA
Shape: Rectangular
Sidemarker: w/
No./LEDs: 3
Approvals: CE
E-approval: Yes

171868 LED Position Lamp



Voltage: 12/24
Watt: 0.3-0.6

Dim.: 72x26x24 mm
Cable length: 5000 mm
Dist. mount. holes:
61 mm

Type: LED
Colour: Black
Colour/glass: White
Material: PP
Material/dome: PMMA
Shape: Rectangular
Bracket: Adjustable
Sidemarker lamp: w/
No./LEDs: 3
Approvals: CE
E-approval: Yes

171956 LED Side Marker Lamp

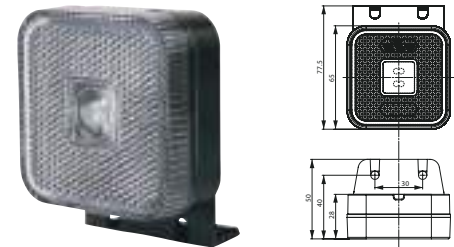

Voltage: 12-24
Watt: 1

Dim.: 65x65x28 mm
Cable length: 220 mm
Dist. mount. holes:
30 mm

Type: LED
Colour/glass: White
Material: ABS plastic
Material/dome: PMMA
Shape: Square
Bracket: Angled
Reflector: w/
Sidemarker lamp: w/
No./LEDs: 2
Tightness norm: IP 68
E-approval: Yes

172038 LED Position Lamp

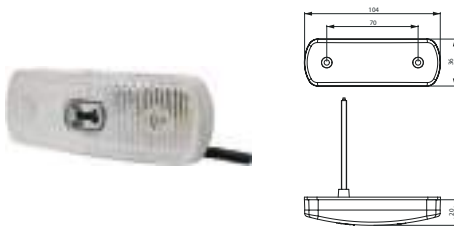

Voltage: 12/24
Watt: 0.49

Dim.: 104x36x20 mm
Cable length: 500 mm
Dist. mount. holes:
70 mm

Type: LED
Colour/glass: White
Material: Shockproof plastic
Shape: Rectangular
Reflector: w/
Fixing screw: 2
Sidemarker: w/
No./LEDs: 1
E-approval: Yes

172039 LED Position Lamp



Voltage: 12/24
Watt: 0.49

Dim.: 104 x 36 x
19.6 mm
Cable length: 500 mm
Dist. mount. holes:
52 mm

Type: LED
Colour/glass: White
Material: Shockproof plastic
Bracket: Angled
Reflector: w/
Fixing screw: 2
Sidemarker: w/
No./LEDs: 1
E-approval: Yes

172043 LED Position Lamp

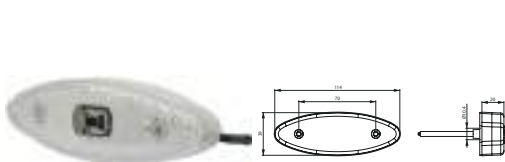

Voltage: 12/24
Watt: 0.44

Dim.: 114x39x20 mm
Cable length: 500 mm
Dist. mount. holes:
70 mm

Type: LED
Colour/glass: White
Material: Shockproof plastic
Reflector: w/
Fixing screw: 2
Sidemarker: w/
No./LEDs: 1
E-approval: Yes



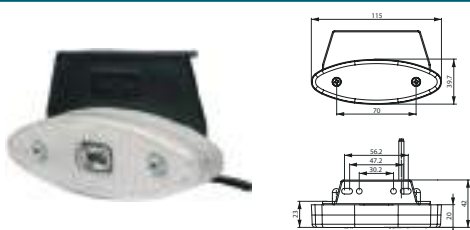





172044 LED Position Lamp

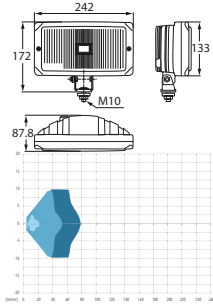

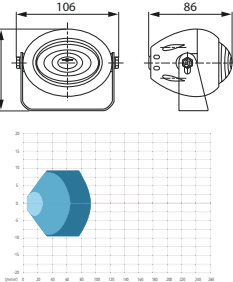
Voltage: 12/24
Watt: 0.44

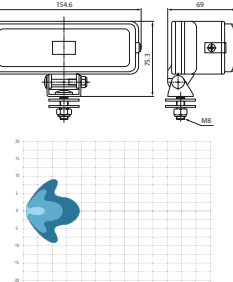
Dim.: 115x39.7x20 mm
Cable length: 500 mm
Dist. mount. holes:
52 mm

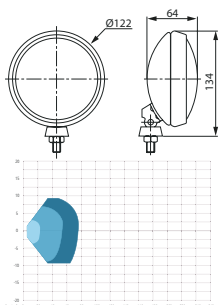
Type: LED
Colour/glass: White
Material: Shockproof plastic
Shape: Oval
Bracket: Angled
Reflector: w/
Fixing screw: 2
Sidemarker: w/
No./LEDs: 1
E-approval: Yes

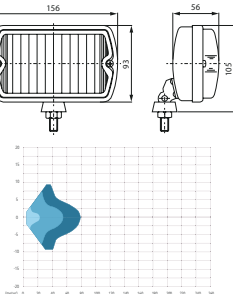
FOG LAMPS			
170616 Fog Lamp			
<i>Light unit: HC-CARGO 170622.</i>			
 	Bulb incl.: No Watt: 55 Watt 2: 70	Dim.: 242x172x87.8 mm Light aperture: 240x170 mm	Type: Fog light Bulb type: H3 Bulb type 2: H3 Socket type: PK22s Socket type 2: PKY22s Colour: Yellow Material: Metal Material/dome: Glass Shape: Rectangular Mount.: Upright/pendant E-approval: Yes
171360 Fog Lamp			
 	Bulb incl.: No Watt: 55 Watt 2: 70	Dim.: 106x84.5x86 mm Light aperture: 55x35 mm	Type: Fog light Bulb type: H3 Bulb type 2: H3 Socket type: PK22s Socket type 2: PK22s Material: Shockproof plastic Material/dome: Glass Shape: Oval Mount.: U-bracket w/ 2 holes E-approval: Yes
171362 Fog Lamp			
 	Bulb incl.: No Watt: 55 Watt 2: 70	Dim.: 154.6x75.3x69 mm Light aperture: 130x35 mm	Type: Fog light Bulb type: H3 Bulb type 2: H3 Socket type: PK22s Socket type 2: PK22s Material: Shockproof plastic Material/dome: Glass Shape: Rectangular Mount.: U-bracket w/ 1 bolt E-approval: No
171364 Fog Lamp			
 	Bulb incl.: No Voltage: 12/24 Watt: 55/70 Watt: 55 Watt 2: 70	Dim.: 122x134x64 mm Light aperture: 95 mm	Type: Fog light Bulb type: H3 Bulb type 2: H3 Socket type: PK22s Socket type 2: PK22s Colour: Black Material: Metal Material/dome: Glass Shape: Round Mount.: Mounted below E-approval: No
171366 Fog Lamp			
 	Bulb incl.: No Watt: 55 Watt 2: 70	Dim.: 156x105x56 mm Light aperture: 110x75 mm	Type: Fog light Bulb type: H3 Bulb type 2: H3 Socket type: PK22s Socket type 2: PK22s Colour: Black Material: Metal Material/dome: Glass Shape: Rectangular Mount.: Mounted below E-approval: Yes

TRACTOR HEAD LAMPS

170310 Head Lamp

For upright fixing.

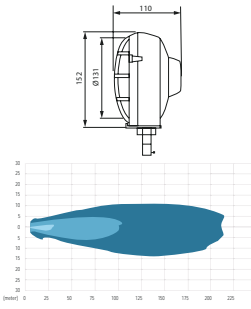

Bulb incl.: No
Watt: 45/40
Watt 2: 55/50
Watt 3: 4

Dim.: 152x110 mm
Light aperture:
131 mm

Socket type: P45t
Socket type 2: P45t
Socket type 3: BA9s
Colour: Black
Material: Plastic
Material/dome: Glass
Shape: Round
Mount.: Vertical
Sidemarker: w/
Grill: w/
Asymmetric light: w/
RH/LH: RH/LH
E-approval: Yes

170311 Head Lamp

Horizontal fixing.

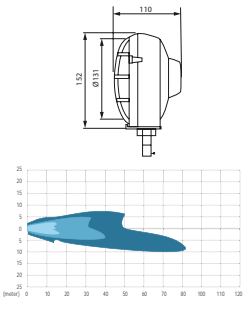

Bulb incl.: No
Watt: 45/40
Watt 2: 55/50
Watt 3: 4

Dim.: 152x110 mm
Light aperture:
131 mm

Socket type: P45t
Socket type 2: P45t
Socket type 3: BA9s
Colour: Black
Material: Plastic
Material/dome: Glass
Shape: Round
Mount.: Horizontal
Sidemarker: w/
Grill: w/
Asymmetric light: w/
RH/LH: LH
E-approval: Yes

171006 Head Lamp

Light unit: HC-CARGO 171007.

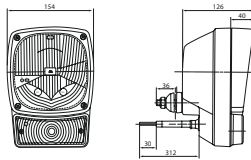

Bulb incl.: Yes
12 V
Watt: 60/55
Watt 2: 75/70

Dim.: 208x154x126 mm
Light aperture:
142 mm

Bulb type: H4
Bulb type 2: H4
Socket type: P43t
Socket type 2: P43t
Colour: Black
Material: Shockproof plastic
Material/dome: Glass
Shape: Rectangular
Mount.: Horizontal/vertical
Flasher light: w/
Sidemarker: w/
Asymmetric light: w/
RH/LH: RH/LH
E-approval: Yes

SPARE PARTS

171007 Light Unit

Servicing: HC-CARGO 171006, 170926

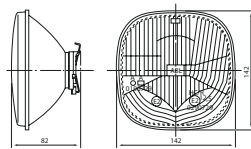

Bulb incl.: No
Watt: 60/55
Watt 2: 75/70

Dim.: 142x142x82 mm
Light aperture:
142 mm

Bulb type: H4
Bulb type 2: H4
Socket type: P43t
Socket type 2: P43t
Material: Glass
Shape: Square
Asymmetric light: w/
E-approval: Yes

REFLECTORS

170142 Reflector

w/ 5 mm bolt.



OD: 60 mm

Colour: Red
Material: Plastic
Shape: Round
Approvals: I A approval
E-approval: Yes

170143 Reflector

w/ 5 mm bolt.



OD: 83 mm

 Colour: Red
 Material: Plastic
 Shape: Round
 Approvals: I A approval
 E-approval: Yes

170144 Reflector

 Dim.: 160x160x160 mm
 Dist. mount. holes:
 85 mm

 Colour: Red
 Material: Plastic
 Shape: Triangle
 Mount.: 2 screws
 Approvals: III A approval
 E-approval: Yes

170163 Reflector

 Dim.: 155x135 mm
 Dist. mount. holes:
 70 mm

 Colour: Red
 Material: Plastic
 Shape: Triangle
 Mount.: 2 holes
 Approvals: III A approval
 E-approval: Yes

170165 Reflector

 OD: 60 mm
 Hole size: 4 mm

 Colour: Red
 Material: Plastic
 Shape: Round
 Approvals: I A approval
 E-approval: Yes

170169 Reflector

 OD: 60 mm
 Hole size: 4 mm

 Colour: Orange
 Material: Plastic
 Shape: Round
 Approvals: I A approval
 E-approval: Yes

170170 Reflector





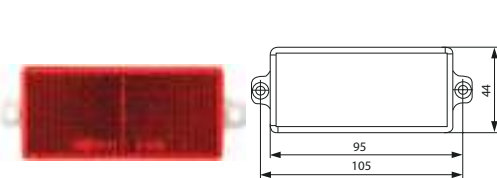

 OD: 60 mm
 Hole size: 4 mm

 Colour: White
 Material: Plastic
 Shape: Round
 Approvals: I A approval
 E-approval: Yes

170623 Reflector

 Dim.: 95x44 mm
 Dist. mount. holes:
 105 mm

 Colour: Red
 Material: Plastic
 Shape: Rectangular
 Mount.: 2 holes
 Approvals: I A approval
 E-approval: Yes

170624 Reflector		EL. SPECIFICATIONS	DIMENSIONS	ADDITIONAL SPECIFICATIONS
			Dim.: 95x44 mm Dist. mount. holes: 105 mm	Colour: Orange Material: Plastic Shape: Rectangular Mount.: 2 holes Approvals: I A approval E-approval: Yes
170625 Reflector		EL. SPECIFICATIONS	DIMENSIONS	ADDITIONAL SPECIFICATIONS
			Dim.: 95x44 mm Dist. mount. holes: 105 mm	Colour: White Material: Plastic Shape: Rectangular Mount.: 2 holes Approvals: I A approval E-approval: Yes
170626 Reflector		EL. SPECIFICATIONS	DIMENSIONS	ADDITIONAL SPECIFICATIONS
			Dim.: 95x44 mm	Colour: Red Material: Plastic Shape: Rectangular Mount.: Self adhesive Approvals: I A approval E-approval: Yes
170627 Reflector		EL. SPECIFICATIONS	DIMENSIONS	ADDITIONAL SPECIFICATIONS
			Dim.: 95x44 mm	Colour: Orange Material: Plastic Shape: Rectangular Mount.: Self adhesive Approvals: I A approval E-approval: Yes
170628 Reflector		EL. SPECIFICATIONS	DIMENSIONS	ADDITIONAL SPECIFICATIONS
			Dim.: 95x44 mm	Colour: White Material: Plastic Shape: Rectangular Mount.: Self adhesive Approvals: I A approval E-approval: Yes
170629 Reflector		EL. SPECIFICATIONS	DIMENSIONS	ADDITIONAL SPECIFICATIONS
			Dim.: 71x35 mm	Colour: Red Material: Plastic Shape: Rectangular Mount.: Self adhesive Approvals: I A approval E-approval: Yes
170630 Reflector		EL. SPECIFICATIONS	DIMENSIONS	ADDITIONAL SPECIFICATIONS
			Dim.: 71x35 mm	Colour: Orange Material: Plastic Shape: Rectangular Mount.: Self adhesive Approvals: I A approval E-approval: Yes

170631 Reflector 		Dim.: 71x35 mm	Colour: White Material: Plastic Shape: Rectangular Mount.: Self adhesive Approvals: I A approval E-approval: Yes
170675 Reflector 		OD: 60 mm	Colour: Red Material: Plastic Shape: Round Mount.: Self adhesive Approvals: I A approval E-approval: Yes
170676 Reflector 		OD: 60 mm	Colour: Orange Material: Plastic Shape: Round Mount.: Self adhesive Approvals: I A approval E-approval: Yes
170677 Reflector 		OD: 60 mm	Colour: White Material: Plastic Shape: Round Mount.: Self adhesive Approvals: I A approval E-approval: Yes
170729 Reflector 		OD: 83 mm Hole size: 4 mm	Colour: Red Material: Plastic Shape: Round Mount.: 1 hole Approvals: I A approval E-approval: Yes
171228 Reflector 		Dim.: 90x40 mm Dist. mount. holes: 79 mm	Colour: Red Material: Plastic Shape: Rectangular Mount.: 2 holes Approvals: I A approval E-approval: Yes
171230 Reflector 		Dim.: 90x40 mm Dist. mount. holes: 79 mm	Colour: Orange Material: Plastic Shape: Rectangular Mount.: 2 holes Approvals: I A approval E-approval: Yes

ACCESSORIES
171536 Bracket

ID: 60 mm

No./mounting holes: 1 (0)

REAR MARKING TRAILERS
170397 Reflector Board

Yellow: high intensive reflex. Class - A. Red: fluorescent.

Dim.: 1132x200 mm

 Colour: Red/yellow
 Material: Aluminium
 Shape: Rectangular
 Approvals: ECE70
 E-approval: Yes

170398 Reflector Board Set

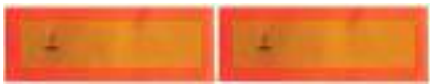
Yellow: high intensive reflex. Class - A. Red: fluorescent. 2 pcs.

Dim.: 566x200 mm

 Colour: Red/yellow
 Material: Aluminium
 Shape: Rectangular
 Approvals: ECE70
 E-approval: Yes

170403 Reflector Foil Set

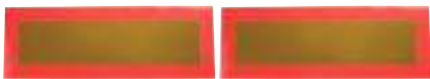
Yellow: high intensive reflex. Class - A. Red: fluorescent. 2 pcs.

Dim.: 566x200 mm

 Colour: Red/yellow
 Shape: Rectangular
 Mount.: Self adhesive
 Approvals: ECE70
 E-approval: Yes

171554 Reflector Tape 50 m

Safety marking for heavy vehicles and trailers. Mounting on rigid surface.

Dim.: 50000 mm

 Colour: Yellow
 Mount.: Self adhesive
 Approvals: ECE104
 E-approval: Yes

171555 Reflector Tape 50 m

Safety marking for heavy vehicles and trailers. Mounting on rigid surface.

Dim.: 50000 mm

 Colour: White
 Mount.: Self adhesive
 Approvals: ECE104
 E-approval: Yes

171556 Reflector Tape 50 m

Safety marking for heavy vehicles and trailers. Mounting on rigid surface.



Dim.: 50000 mm

Colour: Red
Mount.: Self adhesive
Approvals: ECE104
E-approval: Yes

171570 Reflector Board Set

Yellow: high intensitive reflex. Class 3. Red: fluorescent. 2 pcs.



Dim.: 566x197x0.8 mm

Colour: Red/yellow
Material: Aluminium
Shape: Rectangular
Approvals: ECE70-01
E-approval: Yes

171572 Reflector Foil Set

Yellow: high intensitive reflex. Class 3. Red: fluorescent. 2 pcs.



Dim.: 566x197 mm

Colour: Red/yellow
Shape: Rectangular
Mount.: Self adhesive
Approvals: ECE70-01
E-approval: Yes

171575 Reflector Board Set

Yellow: high intensitive reflex. Class 3. Red: fluorescent. 4 pcs.

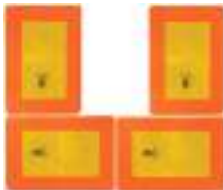

Dim.: 283x197x0.8 mm

Colour: Red/yellow
Material: Aluminium
Shape: Rectangular
Approvals: ECE70-01
E-approval: Yes

REAR MARKING TRUCKS

170394 Reflector Board

Yellow: high intensitive reflex. Class II. Red: fluorescent. 1 pcs.



Dim.: 1132x140x1.2 mm

Colour: Red/yellow
Material: Aluminium
Shape: Rectangular
Approvals: ECE70
E-approval: Yes

170395 Reflector Board Set

Yellow: high intensitive reflex. Class II. Red: fluorescent. 2 pcs.



Dim.: 565x132x0.8 mm

Colour: Red/yellow
Material: Aluminium
Shape: Rectangular
Approvals: ECE70
E-approval: Yes

170396 Reflector Board Set

Yellow: high intensitive reflex. Class II. Red: fluorescent. 4 pcs.



Dim.: 283x140x0.8 mm

Colour: Red/yellow
Material: Aluminium
Shape: Rectangular
Approvals: ECE70
E-approval: Yes

EL. SPECIFICATIONS		DIMENSIONS	ADDITIONAL SPECIFICATIONS
170401 Reflector Foil Set			
<i>Yellow: high intensive reflex. Class II. Red: fluorescent. 2 pcs.</i>			
		Dim.: 566x140 mm	Colour: Red/yellow Shape: Rectangular Mount.: Self adhesive Approvals: ECE70 E-approval: Yes
170402 Reflector Foil Set			
<i>Yellow: high intensive reflex. Class II. Red: fluorescent. 4 pcs.</i>			
		Dim.: 283x140 mm	Colour: Red/yellow Shape: Rectangular Mount.: Self adhesive Approvals: ECE70 E-approval: Yes
171568 Reflector Board Set			
<i>Yellow: high intensive reflex. Class 3. Red: fluorescent. 2 pcs.</i>			
		Dim.: 565x132x0.8 mm	Colour: Red/yellow Material: Aluminium Shape: Rectangular Approvals: ECE70-01 E-approval: Yes
171571 Reflector Foil Set			
<i>Yellow: high intensive reflex. Class 3. Red: fluorescent. 2 pcs.</i>			
		Dim.: 566x132 mm	Colour: Red/yellow Shape: Rectangular Mount.: Self adhesive Approvals: ECE70-01 E-approval: Yes
171878 Warning Liftflag Right		Servicing: HC-CARGO 171880, 171882	
<i>Right. Class 1.</i>			
		Dim.: 410x250 mm	Colour: Red/white Material: Canvas + film Shape: Rectangular
171879 Warning Liftflag		Servicing: HC-CARGO 171881, 171882	
<i>Left. Class 1.</i>			
		Dim.: 410x250 mm	Colour: Red/white Material: Canvas + film Shape: Rectangular
171880 Warning Liftflag w/ alu		Servicing: HC-CARGO 171881, 171882	
<i>w/ alu support. Right. Class 1.</i>			
		Dim.: 410x250 mm	Colour: Red/white Material: Canvas + film Shape: Rectangular

171881 Warning Liftflag w/ alu
w/ alu support. Left. Class 1.



Dim.: 410x250 mm

Colour: Red/white
Material: Canvas + film
Shape: Rectangular

171882 Warning Liftflag w/ alu Kit
w/ alu support. Kit. Class 1.



Dim.: 410x250 mm

Colour: Red/white
Material: Canvas + film
Shape: Rectangular

171891 Wide Load Marking
For Agriculture. Class 1. DIN 11030.



Dim.: 423x423x0.8 mm

Colour: Red/white
Material: Zinc + film
Shape: Square

171892 Wide Load Marking Kit
For Agriculture. Kit. Class 1. DIN 11030.



Dim.: 564x282x0.8 mm

Colour: Red/white
Material: Zinc + film
Shape: Rectangular

171893 Wide Load Marking
Class 1.



Dim.: 900x300x2 mm

Colour: Black/yellow/red
Material: Aluminium + film
Shape: Rectangular
Approvals: No Homogation required

171894 Wide Load Marking
Class 1.



Dim.: 565x200x2 mm

Colour: Black/yellow/red
Material: Aluminium + film
Shape: Rectangular
Approvals: No Homogation required

WARNING TRIANGLES

170171 Warning Triangle
Break down warning triangle. Supplied in plastic carrying box.



Shape: Triangle
E-approval: Yes

TAIL LIGHTS
MULTI FUNCTION LAMPS
TRAILER LAMPS CONVENTIONAL
170602 Multi Function Lamp Servicing: RVI Renault, Pegaso

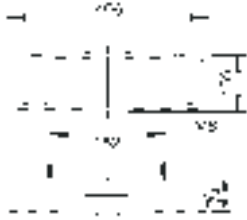
Right: HC-CARGO 170603. Lens: HC-CARGO 170665.

 Bulb incl.: No
 Watt: 21
 Watt 2: 5
 Watt 3: 10

 Dim.: 406x135x74 mm
 Dist. mount. holes:
 152 mm

 Socket type: BA15S
 Socket type 2: BA15S
 Socket type 3: BA15S
 Material: Shockproof plastic
 Shape: Rectangular
 Reflector: w/
 Flasher light: w/
 Numberplate light: w/
 Rear/fog lamp: w/
 Reverse light: w/
 Tail light: w/
 Stop light: w/
 RH/LH: LH
 E-approval: Yes

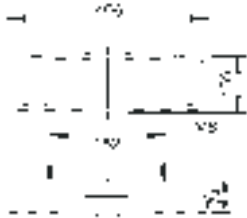
170603 Multi Function Lamp Servicing: RVI Renault, Pegaso

Lens: HC-CARGO 170665. Left: HC-CARGO 170602. Lens: HC-CARGO 170665.

 Bulb incl.: No
 Watt: 21
 Watt 2: 5
 Watt 3: 10

 Dim.: 406x135x74 mm
 Dist. mount. holes:
 152 mm

 Socket type: BA15S
 Socket type 2: BA15S
 Socket type 3: BA15S
 Material: Shockproof plastic
 Shape: Rectangular
 Reflector: w/
 Flasher light: w/
 Rear/fog lamp: w/
 Reverse light: w/
 Tail light: w/
 Stop light: w/
 RH/LH: RH
 E-approval: Yes

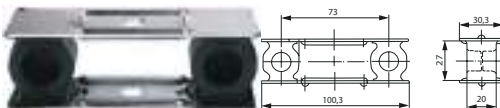
170604 Vibration Damper Servicing: HC-CARGO 170602, 170603

Gives a longer life to the bulbs.

170665 Lens, Rear Lamp Servicing: HC-CARGO 170602

170893 Multi Function Lamp

Left: HC-CARGO 170895. 2 sockets for tail light. Lens: HC-CARGO 171062.

 Bulb incl.: No
 Watt: 21

 Dim.: 335x96x83 mm
 Dist. mount. holes:
 45 mm

 Socket type: BA15S
 Material: Shockproof plastic
 Shape: Rectangular
 Flasher light: w/
 Tail light: w/
 Stop light: w/
 RH/LH: RH

170895 Multi Function Lamp

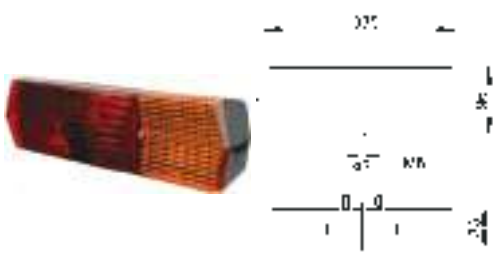
Right: HC-CARGO 170893. 2 bulb holders for tail light. Lens: HC-CARGO 171062.

 Bulb incl.: No
Watt: 21

 Dim.: 335x96x83 mm
Dist. mount. holes:
45 mm

 Socket type: BA15S
Material: Shockproof plastic
Shape: Rectangular
Flasher light: w/
Tail light: w/
Stop light: w/
RH/LH: LH

170910 Lens, Rear Lamp

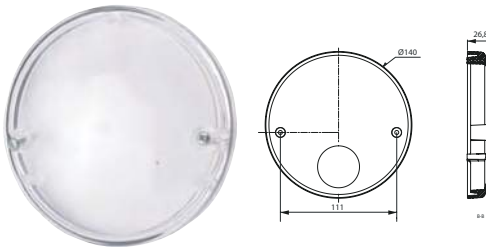
Servicing: HC-CARGO 170909

 Dim.: 140x26.8 mm
Dist. mount. holes:
111 mm

 Colour: White
Shape: Round

170916 Multi Function Lamp

Servicing: Scania, Universal

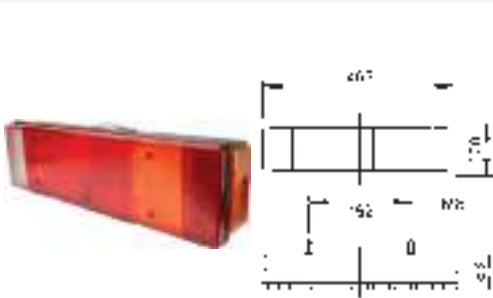
Right: HC-CARGO 170917. 2 bulb holders for tail light. Lens: HC-CARGO 170968.

 Bulb incl.: No
Watt: 21
Watt 2: 5
Watt 3: 10

 Dim.: 465x130x83 mm
Dist. mount. holes:
152 mm

 Socket type: BA15S
Socket type 2: BA15S
Socket type 3: BA15S
Material: Shockproof plastic
Shape: Rectangular
Reflector: w/
Flasher light: w/
Numberplate light: w/
Rear/fog lamp: w/
Reverse light: w/
Sidemarker lamp: w/
Tail light: w/
Stop light: w/
RH/LH: LH

170917 Multi Function Lamp

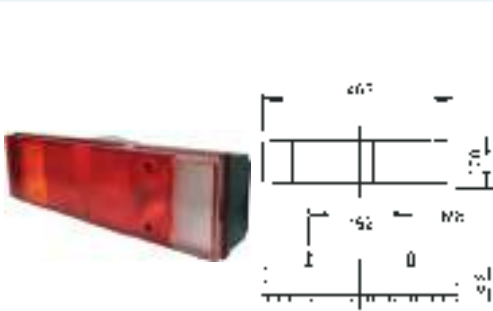
Servicing: Scania, Universal

Left: HC-CARGO 170916. 2 bulb holders for tail light. Lens: HC-CARGO 170968.

 Bulb incl.: No
Watt: 21
Watt 2: 5
Watt 3: 10

 Dim.: 465x130x83 mm
Dist. mount. holes:
152 mm

 Socket type: BA15S
Socket type 2: BA15S
Socket type 3: BA15S
Material: Shockproof plastic
Shape: Rectangular
Reflector: w/
Flasher light: w/
Numberplate light: w/
Rear/fog lamp: w/
Reverse light: w/
Sidemarker lamp: w/
Tail light: w/
Stop light: w/
RH/LH: RH
E-approval: Yes

170922 Multi Function Lamp

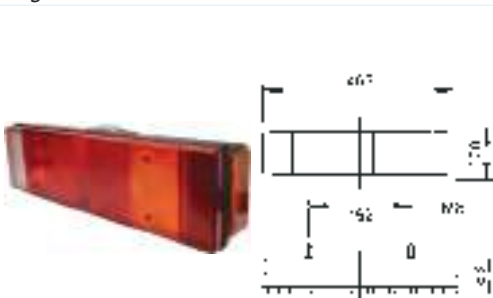
Servicing: MAN, Universal

Right: HC-CARGO 170923. Lens: HC-CARGO 170968.

 Bulb incl.: No
Watt: 21
Watt 2: 5
Watt 3: 10

 Dim.: 465x130x83 mm
Dist. mount. holes:
152 mm

 Socket type: BA15S
Socket type 2: BA15S
Socket type 3: BA15S
Material: Shockproof plastic
Shape: Rectangular
Reflector: w/
Flasher light: w/
Numberplate light: w/
Rear/fog lamp: w/
Sidemarker lamp: w/
Tail light: w/
Stop light: w/
RH/LH: LH
E-approval: Yes

170923 Multi Function Lamp

Servicing: MAN, Universal

Left: HC-CARGO 170922. 2 bulb holders for tail light. Lens: HC-CARGO 170968.

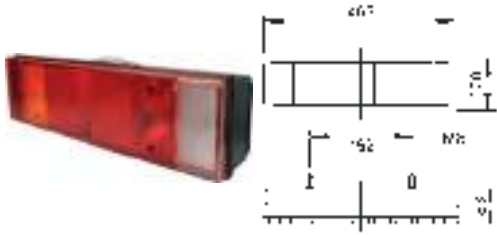
 Bulb incl.: No
 Watt: 21
 Watt 2: 5
 Watt 3: 10

 Dim.: 465x130x83 mm
 Dist. mount. holes:
 152 mm

 Socket type: BA15S
 Socket type 2: BA15S
 Socket type 3: BA15S
 Material: Shockproof plastic
 Shape: Rectangular
 Reflector: w/
 Flasher light: w/
 Numberplate light: w/
 Rear/fog lamp: w/
 Reverse light: w/
 Sidemarker lamp: w/
 Tail light: w/
 Stop light: w/
 RH/LH: RH
 E-approval: Yes

170968 Lens, Rear Lamp

Servicing: HC-CARGO 170916, 170917



Dim.: 465x130 mm

Shape: Rectangular

170990 Multi Function Lamp

Servicing: Commercial trailers

Left: HC-CARGO 170991.

 Bulb incl.: No
 Watt: 21
 Watt 2: 20/5
 Watt 3: 5
 Watt 4: 10

 Dim.: 418x148x90 mm
 Dist. mount. holes:
 152 mm

 Socket type: BA15S
 Socket type 2: BAY15d
 Socket type 3: BA15S
 Socket type 4: BA10s
 Material: Shockproof plastic
 Shape: Rectangular
 Reflector: w/
 Flasher light: w/
 Numberplate light: w/
 Rear/fog lamp: w/
 Sidemarker lamp: w/
 Tail light: w/
 Stop light: w/
 RH/LH: RH
 E-approval: Yes

170991 Multi Function Lamp

Servicing: Commercial trailers

Right: HC-CARGO 170990. Lens: HC-CARGO 170995.

 Bulb incl.: No
 Watt: 21
 Watt 2: 21/5
 Watt 3: 5
 Watt 4: 10

 Dim.: 418x148x90 mm
 Dist. mount. holes:
 152 mm

 Socket type: BA15S
 Socket type 2: BAY15d
 Socket type 3: BA15S
 Socket type 4: BA10s
 Material: Shockproof plastic
 Shape: Rectangular
 Reflector: w/
 Flasher light: w/
 Numberplate light: w/
 Rear/fog lamp: w/
 Sidemarker lamp: w/
 Tail light: w/
 Stop light: w/
 RH/LH: LH
 E-approval: Yes

170998 Multi Function Lamp





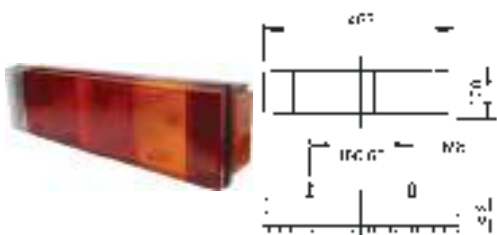

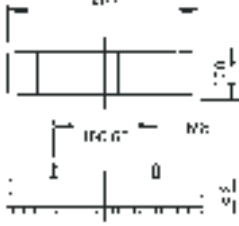

Servicing: Iveco

Multi function lamp: HC-CARGO 170999. 2 bulb holders for tail light. Lens: HC-CARGO 171000.

 Bulb incl.: No
 Watt: 21
 Watt 2: 5

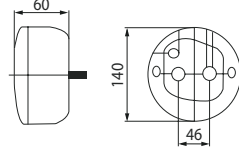
 Dim.: 465x130x83 mm
 Dist. mount. holes:
 190/60 mm

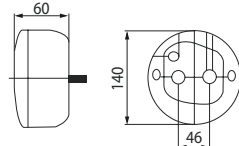
 Socket type: BA15S
 Socket type 2: BA15S
 Material: Shockproof plastic
 Shape: Rectangular
 Reflector: w/
 Flasher light: w/
 Rear/fog lamp: w/
 Sidemarker lamp: w/
 Tail light: w/
 Stop light: w/
 RH/LH: RH/LH
 E-approval: Yes

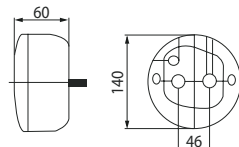
EL. SPECIFICATIONS		DIMENSIONS	ADDITIONAL SPECIFICATIONS
170999 Multi Function Lamp Servicing: Iveco			
<i>Multi function lamp: HC-CARGO 170998. 2 bulb holders for tail light. Lens: HC-CARGO 171000.</i>			
 	<p>Bulb incl.: No Watt: 21 Watt 2: 5 Watt 3: 10</p>	<p>Dim.: 465x130x83 mm Dist. mount. holes: 190/60 mm</p>	<p>Socket type: BA15S Socket type 2: BA15S Socket type 3: BA15S Material: Shockproof plastic Shape: Rectangular Reflector: w/ Flasher light: w/ Numberplate light: w/ Rear/fog lamp: w/ Sidemarker lamp: w/ Tail light: w/ Stop light: w/ RH/LH: RH/LH E-approval: Yes</p>
171000 Lens, Rear Lamp Servicing: HC-CARGO 170998, 170999			
		<p>Dim.: 465x130x83 mm</p>	<p>Shape: Rectangular</p>
171062 Lens, Rear Lamp Servicing: HC-CARGO 170895, 170893			
		<p>Dim.: 335x96 mm</p>	<p>Material: Shockproof plastic Shape: Rectangular Numberplate light: w/</p>
171192 Multi Function Lamp			
<i>Mounting kit: HC-CARGO 171266. Lens: HC-CARGO 171237.</i>			
 	<p>Bulb incl.: No Watt: 21 Watt 2: 5</p>	<p>Dim.: 140x60 mm OD: 140 mm Dist. mount. holes: 46 mm</p>	<p>Socket type: BA15S Socket type 2: BA15S Material: Shockproof plastic Shape: Round Fixing screw: 2 Flasher light: w/ Numberplate light: w/ Tail light: w/ Stop light: w/ E-approval: Yes</p>
171193 Multi Function Lamp			
<i>Mounting kit: HC-CARGO 171266. Lens: HC-CARGO 171237.</i>			
 	<p>Bulb incl.: No Watt: 21 Watt 2: 5</p>	<p>Dim.: 140x60 mm OD: 140 mm Dist. mount. holes: 46 mm</p>	<p>Socket type: BA15S Socket type 2: BA15S Material: Shockproof plastic Shape: Round Fixing screw: 2 Flasher light: w/ Tail light: w/ Stop light: w/ E-approval: Yes</p>
171194 Multi Function Lamp			
<i>Mounting kit: HC-CARGO 171266. Lens: HC-CARGO 171237.</i>			
 	<p>Bulb incl.: No Watt: 21 Watt 2: 5</p>	<p>Dim.: 140x60 mm OD: 140 mm Dist. mount. holes: 45 mm</p>	<p>Socket type: BA15S Socket type 2: BA15S Material: Shockproof plastic Shape: Round Fixing screw: 2 Flasher light: w/ Numberplate light: w/ Tail light: w/ Stop light: w/ E-approval: Yes</p>

171195 Multi Function Lamp

Mounting kit: HC-CARGO 171266. Lens: HC-CARGO 171237.

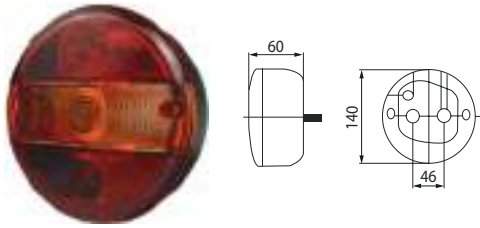
 Bulb incl.: No
 Watt: 21
 Watt 2: 5

 Dim.: 140x60 mm
 OD: 140 mm
 Dist. mount. holes:
 46 mm

 Socket type: BA15S
 Socket type 2: BA15S
 Material: Shockproof plastic
 Shape: Round
 Fixing screw: 2
 Flasher light: w/
 Tail light: w/
 Stop light: w/
 E-approval: Yes

171205 Multi Function Lamp

Servicing: MAN, VW, Mercedes

Left: HC-CARGO 171206. 2 bulb holders for tail light. Lens: HC-CARGO 171263.

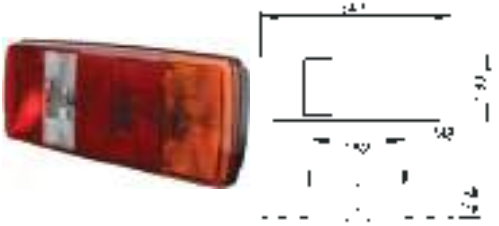
 Bulb incl.: No
 Watt: 21
 Watt 2: 5

 Dim.: 343x133x75 mm
 Dist. mount. holes:
 152 mm

 Socket type: BA15S
 Socket type 2: BA15S
 Material: Shockproof plastic
 Shape: Rectangular
 Reflector: w/
 Flasher light: w/
 Rear/fog lamp: w/
 Tail light: w/
 Stop light: w/
 RH/LH: RH

171206 Multi Function Lamp

Servicing: MAN, VW, Mercedes

Right: HC-CARGO 171205. 2 bulb holders for tail light. Lens: HC-CARGO 171263.

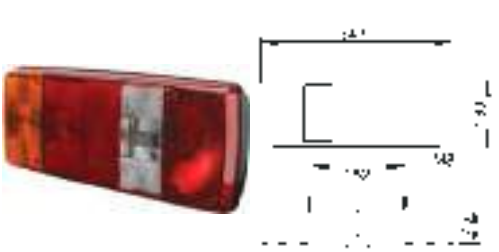

 Bulb incl.: No
 Watt: 21
 Watt 2: 5

 Dim.: 343x133x75 mm
 Dist. mount. holes:
 152 mm

 Socket type: BA15S
 Socket type 2: BA15S
 Material: Shockproof plastic
 Shape: Rectangular
 Reflector: w/
 Flasher light: w/
 Numberplate light: w/
 Rear/fog lamp: w/
 Reverse light: w/
 Tail light: w/
 Stop light: w/
 RH/LH: LH

171209 Multi Function Lamp

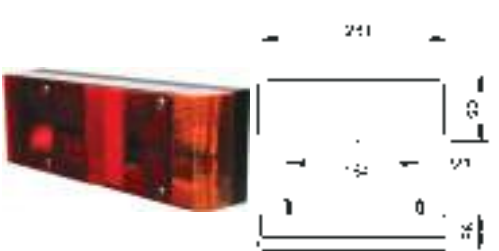
Right: HC-CARGO 171210.



 Bulb incl.: No
 Watt: 21
 Watt 2: 21/5
 Watt 3: 5

 Dim.: 281x99x56 mm
 Dist. mount. holes:
 184 mm

 Socket type: BA15S
 Socket type 2: BAY15d
 Socket type 3: BA15S
 Material: Shockproof plastic
 Shape: Rectangular
 Reflector: w/
 Flasher light: w/
 Numberplate light: w/
 Rear/fog lamp: w/
 Tail light: w/
 Stop light: w/
 RH/LH: LH

171210 Multi Function Lamp

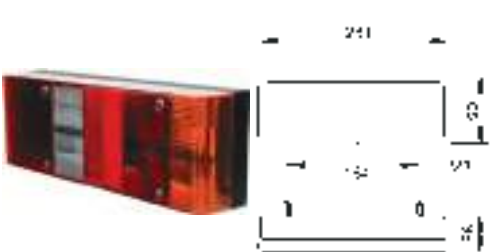
Left: HC-CARGO 171209.

 Bulb incl.: No
 Watt: 21
 Watt 2: 21/5
 Watt 3: 5

 Dim.: 281x99x56 mm
 Dist. mount. holes:
 184 mm

 Socket type: BA15S
 Socket type 2: BAY15d
 Socket type 3: BA15S
 Material: Shockproof plastic
 Shape: Rectangular
 Reflector: w/
 Flasher light: w/
 Numberplate light: w/
 Reverse light: w/
 Tail light: w/
 Stop light: w/
 RH/LH: RH









171237 Lens, Rear Lamp





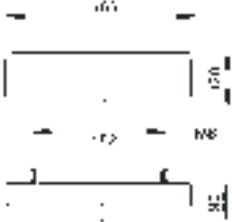

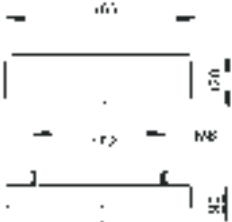
Servicing: HC-CARGO 171192, 171193, 171194, 171195

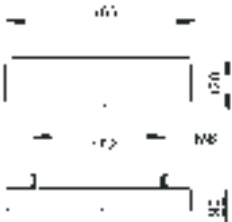

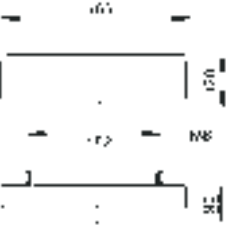
OD: 140 mm

 Type: Tail lamp
 Material: Plastic
 Shape: Circular
 RH/LH: RH/LH

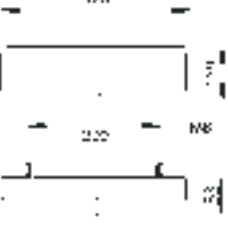
EL. SPECIFICATIONS		DIMENSIONS	ADDITIONAL SPECIFICATIONS
171252 Lens, Rear Lamp 		Servicing: HC-CARGO 171201, 171199 Dim.: 344x147 mm	Material: Shockproof plastic Shape: Rectangular
171263 Lens, Rear Lamp 		Servicing: HC-CARGO 171206, 171205 Dim.: 343x133 mm	Material: Shockproof plastic Shape: Rectangular Reflector: w/ Numberplate light: w/
171266 Repair Kit <i>Circulars.</i> 		Servicing: HC-CARGO 171193, 171195, 171329, 171549, 171550	
171299 Multi Function Lamp <i>Left: HC-CARGO 171302. 2 bulb holders for tail light. Lens: HC-CARGO 171307.</i>  		Servicing: Mercedes Atego Bulb incl.: No Watt: 21 Watt 2: 5 Watt 3: 10 Dim.: 465x130x90 mm Dist. mount. holes: 152 mm	Socket type: BA15S Socket type 2: BA15S Socket type 3: BA15S Material: Shockproof plastic Shape: Rectangular Reflector: w/ Flasher light: w/ Numberplate light: w/ Rear/fog lamp: w/ Sidemarker lamp: w/ Tail light: w/ Stop light: w/ RH/LH: RH E-approval: Yes
171302 Multi Function Lamp <i>Right: HC-CARGO 171299. 2 bulb holders for tail light. Lens: HC-CARGO 171307.</i>  		Servicing: Mercedes Atego Bulb incl.: No Watt: 21 Watt 2: 5 Watt 3: 10 Dim.: 465x130x90 mm Dist. mount. holes: 152 mm	Socket type: BA15S Socket type 2: BA15S Socket type 3: BA15S Material: Shockproof plastic Shape: Rectangular Reflector: w/ Flasher light: w/ Numberplate light: w/ Rear/fog lamp: w/ Sidemarker lamp: w/ Tail light: w/ Stop light: w/ RH/LH: LH E-approval: Yes
171303 Multi Function Lamp <i>Left: HC-CARGO 171306. 2 bulb holders for tail light. Lens: HC-CARGO 171307.</i>  		Servicing: Mercedes Sprinter Bulb incl.: No Watt: 21 Watt 2: 5 Watt 3: 10 Dim.: 465x130x90 mm Dist. mount. holes: 152 mm	Socket type: BA15S Socket type 2: BA15S Socket type 3: BA15S Material: Shockproof plastic Shape: Rectangular Reflector: w/ Flasher light: w/ Numberplate light: w/ Rear/fog lamp: w/ Sidemarker lamp: w/ Tail light: w/ Stop light: w/ RH/LH: RH E-approval: Yes

EL. SPECIFICATIONS		DIMENSIONS	ADDITIONAL SPECIFICATIONS
171306 Multi Function Lamp Servicing: Mercedes Sprinter			
<i>Right: HC-CARGO 171303. 2 bulb holders for tail light. Lens: HC-CARGO 171307.</i>			
 	Bulb incl.: No Watt: 21 Watt 2: 5 Watt 3: 10	Dim.: 465x130x90 mm Dist. mount. holes: 152 mm	Socket type: BA15S Socket type 2: BA15S Socket type 3: BA15S Material: Shockproof plastic Shape: Rectangular Reflector: w/ Flasher light: w/ Numberplate light: w/ Rear/fog lamp: w/ Sidemarker lamp: w/ Tail light: w/ Stop light: w/ RH/LH: LH E-approval: Yes
171307 Lens, Rear Lamp Servicing: HC-CARGO 171299, 171302, 171303, 171306			
		Dim.: 465x130 mm	Shape: Rectangular
171308 Multi Function Lamp Servicing: Mercedes Actros			
<i>Lens: HC-CARGO 171312. Left: HC-CARGO 170602. Lens: HC-CARGO 171311.</i>			
 	Bulb incl.: No Watt: 21 Watt 2: 5 Watt 3: 10	Dim.: 525x139x83 mm Dist. mount. holes: 200 mm	Socket type: BA15S Socket type 2: BA15S Socket type 3: BA15S Material: Shockproof plastic Shape: Rectangular Reflector: w/ Fixing screw: 12 Flasher light: w/ Numberplate light: w/ Rear/fog lamp: w/ Reverse light: w/ Sidemarker lamp: w/ Tail light: w/ Stop light: w/ RH/LH: RH E-approval: Yes
171311 Multi Function Lamp Servicing: Mercedes Actros			
<i>Right: HC-CARGO 171308. Lens: HC-CARGO 171521.</i>			
 	Bulb incl.: No Watt: 21 Watt 2: 5 Watt 3: 10	Dim.: 525x139x83 mm Dist. mount. holes: 200 mm	Socket type: BA15S Socket type 2: BA15S Socket type 3: BA15S Material: Shockproof plastic Shape: Rectangular Reflector: w/ Flasher light: w/ Numberplate light: w/ Rear/fog lamp: w/ Reverse light: w/ Sidemarker lamp: w/ Tail light: w/ Stop light: w/ RH/LH: LH E-approval: Yes
171312 Lens, Rear Lamp Servicing: HC-CARGO 171308			
		Dim.: 525x139 mm	Shape: Rectangular Reflector: w/