



Lighting

Edition 2015/2016



WARNING LIGHTS

ROTATING BEACONS CONVENTIONAL

170295 Rotating Beacon

Lens: HC-CARGO 170308. Motor: HC-CARGO 170505. Plastic base plate: HC-CARGO 170309.



Bulb incl.: Yes
Voltage: 12

OD: 136 mm
Height: 250 mm
Width: 135.5 mm

Bulb type: H1
Lens type: PMMA/ACRYL
Colour: Orange
Model: AEB TYPE 590
Mount.: Standard ISO A - Rod
E-approval: Yes

170296 Rotating Beacon

Lens: HC-CARGO 170308. Motor: HC-CARGO 170506. Plastic base plate: HC-CARGO 170309.

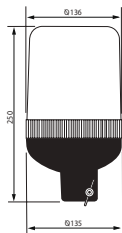

Bulb incl.: Yes
Voltage: 24

OD: 136 mm
Height: 250 mm
Width: 135.5 mm

Bulb type: H1
Lens type: PMMA/ACRYL
Colour: Orange
Model: AEB TYPE 590
Mount.: Standard ISO A - Rod
E-approval: Yes

170435 Rotating Beacon

Lens: HC-CARGO 170308. Motor: HC-CARGO 170505.

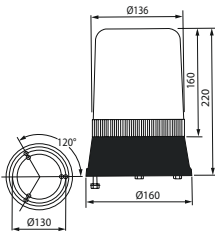

Bulb incl.: Yes
Voltage: 12

OD: 160 mm
Height: 220 mm

Bulb type: H1
Lens type: PMMA/ACRYL
Colour: Orange
Model: AEB TYPE 595
Mount.: Standard ISO B2 (and B1) - Base
E-approval: Yes

170436 Rotating Beacon

Lens: HC-CARGO 170308. Motor: HC-CARGO 170506.

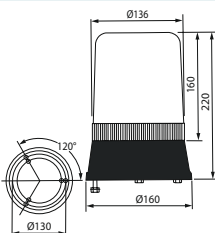

Bulb incl.: Yes
Voltage: 24

OD: 160 mm
Height: 220 mm

Bulb type: H1
Lens type: Amber dome
Colour: Orange
Model: AEB TYPE 595
Mount.: Standard ISO B2 (and B1) - Base
E-approval: Yes

170437 Rotating Beacon

Lens: HC-CARGO 170308. Motor: HC-CARGO 170505. Coil cable: length 2 m.

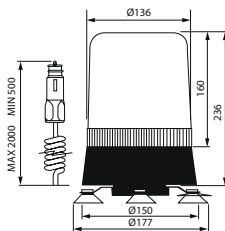

Bulb incl.: Yes
Voltage: 12

OD: 177 mm
Height: 236 mm

Bulb type: H1
Lens type: PMMA/ACRYL
Colour: Orange
Model: AEB TYPE 595 M
Mount.: 3 magnets
Base: Magnetic
Coiled cable incl.: Yes
E-approval: Yes

170438 Rotating Beacon

Lens: HC-CARGO 170308. Motor: HC-CARGO 170505. Coil cable: length 2 m.

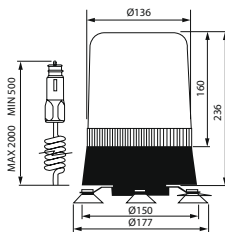

Bulb incl.: Yes
Voltage: 24

OD: 177 mm
Height: 236 mm

Bulb type: H1
Lens type: PMMA/ACRYL
Colour: Orange
Model: AEB TYPE 595 M
Mount.: 3 magnets
Base: Magnetic
Coiled cable incl.: Yes
E-approval: Yes

170490 Rotating Beacon

Lens: HC-CARGO 170492.

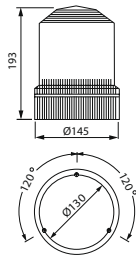

 Bulb incl.: No
Voltage: 12/24

 OD: 145 mm
Height: 193 mm
Width: 145 mm

 Bulb type: H1
Lens type: PMMA/ACRYL
Colour: Orange
Model: TYPE FT 6
Mount.: Standard ISO B2 (and B1) - Base
Tightness norm: IP 55
E-approval: Yes

170491 Rotating Beacon

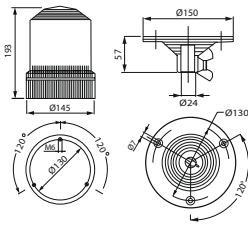
Lens: HC-CARGO 170492.



 Bulb incl.: No
Voltage: 12/24

Height: 250 mm

 Bulb type: H1
Lens type: PMMA/ACRYL
Colour: Orange
Model: TYPE FT 6
Mount.: Standard ISO-DIN A or B fixing
Base: Rigid
Tightness norm: IP 55
E-approval: Yes

170540 Rotating Beacon

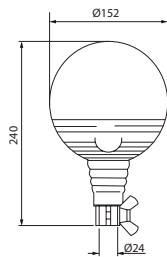
Lens: HC-CARGO 170543.



 Bulb incl.: Yes
Voltage: 12

 OD: 152 mm
Height: 240 mm
Width: 150 mm

 Bulb type: H1
Lens type: Polycarbonate
Colour: Orange
Model: Boule
Mount.: Standard ISO A - Rod
Base: Flexible
Hi impact: Yes
Waterproof: Yes
Tightness norm: IP 66
E-approval: Yes

170541 Rotating Beacon

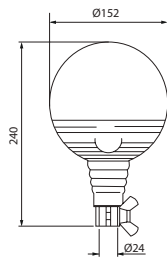
Lens: HC-CARGO 170543.

 Bulb incl.: Yes
Voltage: 24

 OD: 152 mm
Height: 240 mm
Width: 152 mm

 Bulb type: H1
Lens type: Polycarbonate
Colour: Orange
Model: Boule
Mount.: Rod (ISO-DIN A)
Base: Flexible
Hi impact: Yes
Tightness norm: IP 66
E-approval: Yes

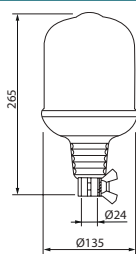
170551 Rotating Beacon

 Bulb incl.: Yes
Voltage: 12

 OD: 135 mm
Height: 265 mm
Width: 135 mm

 Bulb type: H1
Lens type: Polycarbonate
Colour: Orange
Model: TYPE GF 8.8 FLX
Mount.: Standard ISO A - Rod
Base: Flexible
Hi impact: Yes
Tightness norm: IP 54
E-approval: Yes

170598 Rotating Beacon

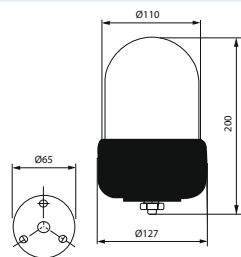
Lens: HC-CARGO 170691.



 Bulb incl.: No
Voltage: 12/24

 OD: 127 mm
Height: 200 mm

 Bulb type: H1
Lens type: PMMA/ACRYL
Colour: Orange
Model: AEB TYPE 525
Mount.: Single bolt
E-approval: Yes

170599 Rotating Beacon

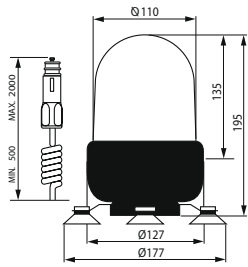
Lens: HC-CARGO 170691.

 Bulb incl.: No
Voltage: 12/24

 OD: 127 mm
Cable length: 2000 mm
Height: 195 mm

 Bulb type: H1
Lens type: PMMA/ACRYL
Colour: Orange
Model: AEB TYPE 525 M
Mount.: 3 magnets
Base: Magnetic
Coiled cable incl.: Yes
E-approval: Yes

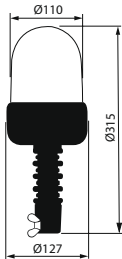
170601 Rotating Beacon

 Bulb incl.: No
Voltage: 12/24

 OD: 127 mm
Height: 315 mm

 Bulb type: H1
Lens type: Polycarbonate
Colour: Orange
Model: AEB TYPE 530 B
Mount.: Standard ISO A - Rod
Base: Flexible
Hi impact: Yes
E-approval: Yes

170798 Rotating Beacon

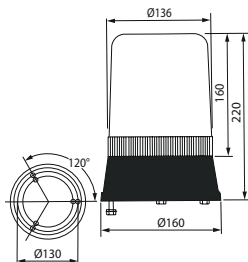
Lens: HC-CARGO 170366. Motor: HC-CARGO 170505, 170506.



 Bulb incl.: No
Voltage: 12/24

 OD: 160 mm
Height: 220 mm

 Bulb type: H1
Lens type: PMMA/ACRYL
Colour: Blue
Model: AEB TYPE 595
Mount.: Standard ISO B2 (and B1) - Base
E-approval: Yes

170830 Rotating Beacon

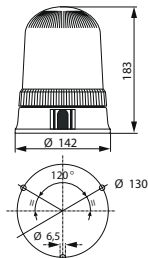
Lens: HC-CARGO 170945.

 Bulb incl.: No
Voltage: 12/24

 OD: 142 mm
Height: 183 mm
Width: 142 mm

 Bulb type: H1
Lens type: PMMA/ACRYL
Colour: Orange
Mount.: Standard ISO B2 (and B1) - Base
E-approval: Yes

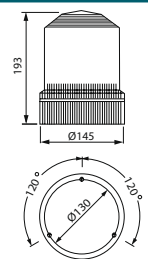
171017 Rotating Beacon

 Bulb incl.: No
Voltage: 12/24

 OD: 145 mm
Height: 193 mm

 Bulb type: H1
Lens type: PMMA/ACRYL
Colour: Blue
Model: TYPE FT 6
Mount.: Standard ISO B2 (and B1) - Base
Tightness norm: IP 55
E-approval: Yes



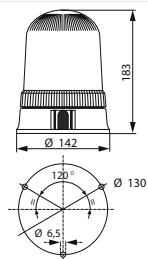





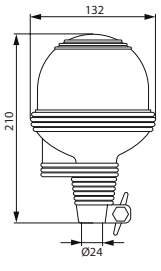

171019 Rotating Beacon

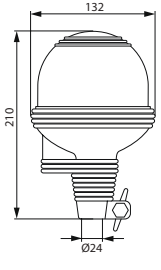
Lens: HC-CARGO 170945.

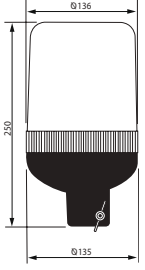
 Bulb incl.: No
Voltage: 12/24

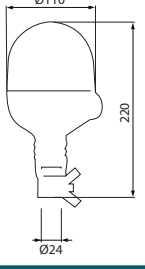
 OD: 142 mm
Height: 183 mm

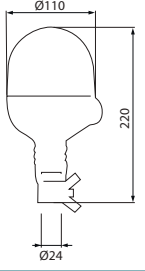
 Bulb type: H1
Lens type: PMMA/ACRYL
Colour: Blue
Model: Astral
Mount.: Standard ISO B2 (and B1) - Base
E-approval: Yes

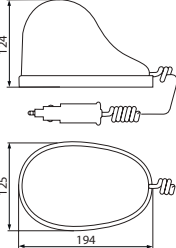
EL. SPECIFICATIONS		DIMENSIONS	ADDITIONAL SPECIFICATIONS
171060 Rotating Beacon			
 	Bulb incl.: Yes Voltage: 12	OD: 132 mm Height: 210 mm	Bulb type: H1 Lens type: Polycarbonate Colour: Orange Model: Megalux Mount.: Standard ISO A - Rod Base: Flexible Hi impact: Yes E-approval: Yes
171061 Rotating Beacon			
 	Bulb incl.: Yes Voltage: 24	OD: 132 mm Height: 210 mm	Bulb type: H1 Lens type: Polycarbonate Colour: Orange Model: Megalux Mount.: Standard ISO A - Rod Base: Flexible Hi impact: Yes E-approval: Yes
171399 Rotating Beacon			
<i>Lens: HC-CARGO 170308. Motor: HC-CARGO 170505, 170506.</i>			
 	Bulb incl.: No Voltage: 12/24	OD: 136 mm Height: 250 mm	Bulb type: H1 Lens type: PMMA/ACRYL Colour: Orange Model: 590 DVO Mount.: Standard ISO A - Rod E-approval: Yes
171423 Rotating Beacon			
 	Bulb incl.: Yes Voltage: 12	OD: 110 mm Height: 220 mm Width: 110 mm	Bulb type: H1 Lens type: Polycarbonate Colour: Orange Model: Microboule Mount.: Standard ISO A - Rod Base: Flexible Hi impact: Yes Tightness norm: IP 55 Approvals: CE E-approval: Yes
171424 Rotating Beacon			
 	Bulb incl.: Yes Voltage: 24	OD: 110 mm Height: 220 mm Width: 110 mm	Bulb type: H1 Lens type: Polycarbonate Colour: Orange Model: Microboule Mount.: Rod (ISO-DIN A) Base: Flexible Hi impact: Yes Tightness norm: IP 55 Approvals: CE E-approval: Yes
171494 Rotating Beacon			
<i>Tested for 200 kmh. Lens: HC-CARGO 171512. 2 mtr. coiled cable. Rubber base.</i>			
 	Bulb incl.: Yes Voltage: 12	OD: 120x186 mm Length: 194 mm Height: 124 mm Width: 125 mm	Bulb type: H1 Lens type: Polycarbonate Colour: Orange Model: GDO Mount.: 1 magnet Base: Magnetic Hi impact: Yes Coiled cable incl.: Yes Tightness norm: IP 55 E-approval: Yes

171577 Rotating Beacon

Lens: HC-CARGO 170945.

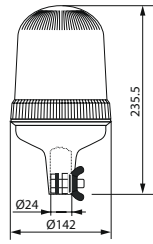

 Bulb incl.: Yes
Voltage: 12

 OD: 142 mm
Height: 235.5 mm
Width: 142 mm

 Bulb type: H1
Colour: Orange
Model: Astral
Mount.: Standard ISO A - Rod
Base: Rigid
E-approval: Yes

171587 Rotating Beacon

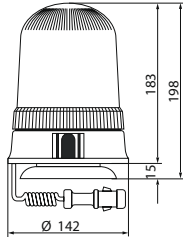
Lens: HC-CARGO 170945.



 Bulb incl.: No
Voltage: 12/24

 OD: 142 mm
Height: 198 mm
Width: 142 mm

 Bulb type: H1
Colour: Orange
Model: Astral
Mount.: 1 magnet
Coiled cable incl.: Yes
E-approval: Yes

171588 Rotating Beacon

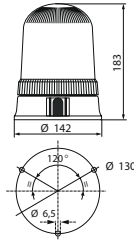
Lens: HC-CARGO 170945.



 Bulb incl.: No
Voltage: 12/24

 OD: 142 mm
Height: 183 mm
Width: 142 mm

 Bulb type: H1
Colour: Orange
Model: Astral
Mount.: Single bolt
E-approval: Yes

171705 Rotating Beacon

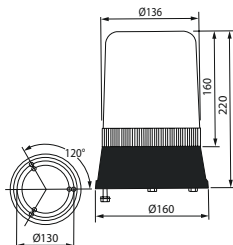
Lens: HC-CARGO 170308. Motor: HC-CARGO 170505, 170506.



 Bulb incl.: No
Voltage: 12/24

 OD: 160 mm
Height: 220 mm

 Bulb type: H1
Lens type: PMMA/ACRYL
Colour: Orange
Model: AEB TYPE 595
Mount.: Plan (ISO-DIN B)
E-approval: Yes

171793 Rotating Beacon

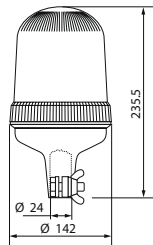
Lens: HC-CARGO 170945.



 Bulb incl.: No
Voltage: 12/24

 OD: 142 mm
Height: 235.5 mm

 Bulb type: H1
Lens type: Polycarbonate
Colour: Orange
Model: Astral flex
Mount.: Standard ISO A - Rod
Base: Flexible
Hi impact: Yes
E-approval: Yes

SPARE PARTS
170308 Dome

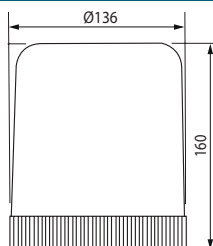
Servicing: HC-CARGO 170295, 170296, 170435, 170436, 170437, 170438, 170798, 171399



 Height: 160 mm
Width: 136 mm

 Lens type: PMMA/ACRYL
Colour: Orange
Model: TYPE 590/595/595M

EL. SPECIFICATIONS	DIMENSIONS	ADDITIONAL SPECIFICATIONS
170309 Base Plate Servicing: HC-CARGO 170295, 170296, 170435, 170436, 170437, 170438, 170798, 171399		
	Height: 90 mm Width: 135 mm	Model: TYPE 590/595/595M
170366 Dome Servicing: HC-CARGO 170295, 170296, 170435, 170436, 170437, 170438, 170798, 171399		
	Height: 160 mm Width: 136 mm	Lens type: PMMA/ACRYL Colour: Blue Model: TYPE 590/595/595M
170505 Beacon Motor Servicing: HC-CARGO 170295, 170296, 170435, 170436, 170437, 170438, 170798, 171399		
	Voltage: 12 Height: 65 mm Width: 30 mm	Model: TYPE 590/595/595M
170506 Beacon Motor Servicing: HC-CARGO 170295, 170296, 170435, 170436, 170437, 170438, 170798, 171399		
	Voltage: 24 Height: 65 mm Width: 30 mm	Model: TYPE 590/595/595M
170528 Base Plate Servicing: HC-CARGO 170491, 170490, 170650, 170651, 171498, 170680		
	Height: 58 mm Width: 150 mm	Model: TYPE FT 6 Mount.: Standard ISO A - Rod
170543 Dome Servicing: HC-CARGO 170540, 170541		
	Height: 120.5 mm Width: 152.5 mm	Lens type: Polycarbonate Colour: Orange Model: Boule Hi impact: Yes

170945 Dome

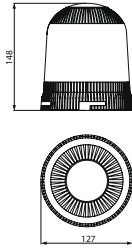
Servicing: HC-CARGO 170830, 171019, 171577, 171587, 171588, 171793, 172027, 172028, 172029, 172030, 172030UK

 Height: 148 mm
Width: 127 mm

 Lens type: PMMA/ACRYL
Colour: Orange
Model: Astral
E-approval: Yes

ACCESSORIES
170525 Beacon Socket

Servicing: HC-CARGO 170490, 171017

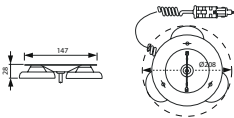
 Cable length: 2000 mm
Height: 28 mm
Width: 147 mm

 Model: TYPE FT 6
Mount.: 3 magnets
Base: Magnetic
Coiled cable incl.: Yes
Tightness norm: IP 55

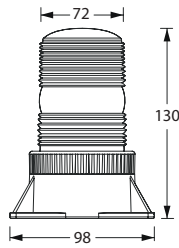
ROTATING BEACONS LED
171673 LED Beacon

Voltage: 11-110

 OD: 98 mm
Length: 98 mm
Height: 130 mm
Width: 72 mm

 Bulb type: LED
Lens type: Polycarbonate
Flash rate: 45 min.
Colour: Orange
Model: LED
Mount.: Plan
Hi impact: Yes
Coiled cable incl.: No
Waterproof: Yes
Tightness norm: IP 66
Approvals: SAE/CE
E-approval: No

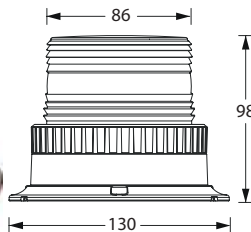
171674 LED Beacon

Voltage: 11-110

 OD: 130 mm
Length: 130 mm
Height: 98 mm
Width: 86 mm

 Bulb type: LED
Lens type: Polycarbonate
Flash rate: 45 min.
Colour: Orange
Model: LED
Mount.: Plan
Hi impact: Yes
Coiled cable incl.: No
Waterproof: Yes
Tightness norm: IP 66
Approvals: SAE/CE
E-approval: No

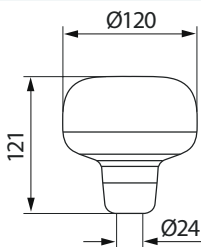
171763 LED Beacon

 Voltage: 12/24
Amp: 1.7/0.8

 OD: 120 mm
Height: 121 mm
Width: 120 mm

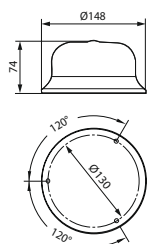
 Bulb type: LED
Lens type: Polycarbonate
Flash rate: 130 min.
Colour: Orange
Material: Aluminium
Mount.: Standard ISO A - Rod
Hi impact: Yes
Waterproof: Yes
Tightness norm: IP 66
E-approval: Yes

171764 LED Beacon

Voltage: 12/24

 OD: 148 mm
Height: 74 mm
Width: 148 mm

 Bulb type: LED
Lens type: Polycarbonate
Flash rate: 130 min.
Colour: Orange
Material: Aluminium
Mount.: Standard ISO B2 (and B1) - Base
Hi impact: Yes
Waterproof: Yes
Tightness norm: IP 66
Approvals: ECE-R65
E-approval: Yes

171918 LED Beacon

Lens: HC-CARGO 171941.

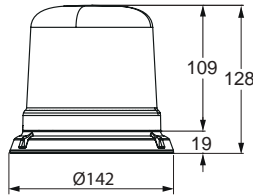

Voltage: 12-24
Amp: 1.2/2.9
Watt: 37

OD: 142 mm
Height: 128 mm
Width: 130 mm

Bulb type: LED
Lens type: Polycarbonate
Colour: Orange
Material: Aluminium
Model: LED
Mount.: Plan
Flash patterns: 11
Hi impact: Yes
Coiled cable incl.: No
Waterproof: Yes
Tightness norm: IP 65
Approvals: SAE/ECE-R65
E-approval: Yes

171919 LED Beacon

Lens: HC-CARGO 171941.

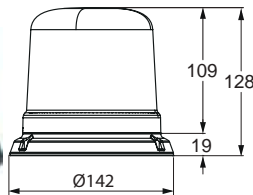

Voltage: 12-24
Amp: 1.2/2.9
Watt: 37

OD: 142 mm
Cable length: 3000 mm
Height: 128 mm
Width: 130 mm

Bulb type: LED
Lens type: Polycarbonate
Colour: Orange
Material: Aluminium
Model: LED
Mount.: Lighter Socket
Base: Magnetic
Flash patterns: 11
Hi impact: Yes
Waterproof: Yes
Tightness norm: IP 65
Approvals: SAE/ECE-R65
E-approval: Yes

171920 LED Beacon

Lens: HC-CARGO 171941.

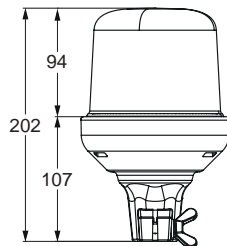

Voltage: 12-24
Amp: 1.2/2.9
Watt: 37

OD: 130 mm
Height: 202 mm
Width: 130 mm

Bulb type: LED
Lens type: Polycarbonate
Colour: Orange
Material: Aluminium
Model: LED
Mount.: Standard ISO A - Rod
Flash patterns: 11
Hi impact: Yes
Coiled cable incl.: No
Waterproof: Yes
Tightness norm: IP 65
Approvals: SAE/ECE-R65
E-approval: Yes

171922 LED Beacon

Lens: HC-CARGO 171942.

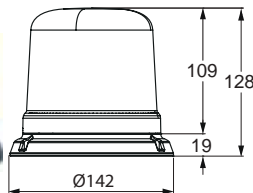

Voltage: 12-24
Amp: 1.2/2.9
Watt: 37

OD: 142 mm
Height: 128 mm
Width: 130 mm

Bulb type: LED
Lens type: Polycarbonate
Colour: Blue
Material: Aluminium
Model: LED
Mount.: 3 magnets
Flash patterns: 11
Hi impact: Yes
Coiled cable incl.: Yes
Waterproof: Yes
Tightness norm: IP 65
Approvals: SAE/ECE-R65
E-approval: Yes

171923 LED Beacon

Lens: HC-CARGO 171942.

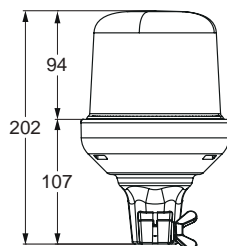

Voltage: 12-24
Amp: 1.2/2.9
Watt: 37

OD: 130 mm
Height: 202 mm
Width: 130 mm

Bulb type: LED
Lens type: Polycarbonate
Colour: Blue
Material: Aluminium
Model: LED
Mount.: Standard ISO A - Rod
Flash patterns: 11
Hi impact: Yes
Waterproof: Yes
Tightness norm: IP 65
Approvals: SAE/ECE-R65
E-approval: Yes

171931 LED Beacon

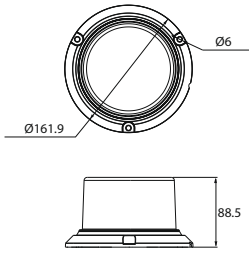

Voltage: 12-36
Watt: 35/44

OD: 161.9 mm
Height: 88.5 mm
Width: 161.9 mm

Bulb type: LED
Colour: Orange
Mount.: Plan
Waterproof: Yes
Tightness norm: IP 67
Approvals: SAE/ECE-R65
E-approval: Yes

171957 LED Beacon

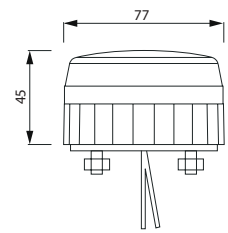

Voltage: 10-100
Amp: 0.1

OD: 77 mm
Height: 45 mm
Dist. mount. holes:
45 mm
Width: 77 mm

Bulb type: LED
Lens type: Polycarbonate
Colour: Orange
Material: Polycarbonate
Mount.: Plan
Flash patterns: 4
Hi impact: Yes
Tightness norm: IP 67
Approvals: CE

171971 LED Beacon

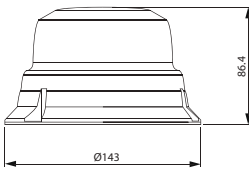

Voltage: 12-24
Watt: 15

OD: 143 mm
Height: 86.4 mm
Width: 143 mm

Bulb type: 8 LED
Colour: Orange
Material: Polycarbonate
Model: LED
Mount.: Plan
Tightness norm: IP 66
Approvals: CE/EMC/ECE-R65
E-approval: Yes

171972 LED Beacon

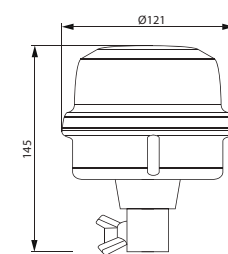

Voltage: 12-24
Watt: 15

OD: 121 mm
Height: 143 mm

Bulb type: 6 LED
Colour: Orange
Material: Polycarbonate
Model: LED
Mount.: Rod (ISO-DIN A)
Hi impact: Yes
Tightness norm: IP 66
Approvals: CE/EMC/ECE-R65
E-approval: Yes

171973 LED Beacon

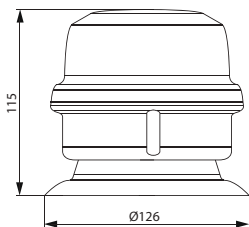

Voltage: 12-24
Watt: 15

OD: 126 mm
Cable length: 2000 mm
Height: 115 mm
Width: 126 mm

Bulb type: 8 LED
Colour: Orange
Material: Polycarbonate
Model: LED
Mount.: Lighter Socket
Base: Magnetic/vacuum
Hi impact: Yes
Coiled cable incl.: Yes
Tightness norm: IP 66
Approvals: CE/EMC/ECE-R65
E-approval: Yes

172027 LED Beacon

Lens: HC-CARGO 170945.

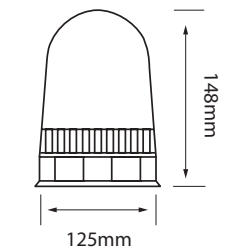

Voltage: 10-30

Length: 1500 mm
Height: 148 mm
Dist. mount. holes:
107 mm
Width: 125 mm

Bulb type: LED
Lens type: Polycarbonate
Flash rate: 3 min.
Colour: Orange
Material: Plastic/nylon/rubber
Model: 80 LEDs
Mount.: Lighter Socket
Base: Magnetic/vacuum
Coiled cable incl.: Yes
Tightness norm: IP 65
Approvals: ECE-R65
E-approval: Yes

172028 LED Beacon

Lens: HC-CARGO 170945.

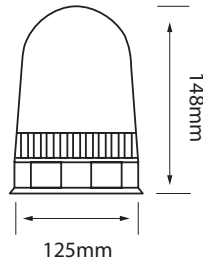

Voltage: 10-30

Height: 148 mm
Dist. mount. holes: 107 mm
Width: 125 mm

Bulb type: LED
Lens type: Polycarbonate
Colour: Orange
Material: Plastic/nylon/rubber
Model: 80 LEDs
Mount.: Plan
Flash patterns: 3
Tightness norm: IP 65
Approvals: ECE-R65
E-approval: Yes

172029 LED Beacon

Lens: HC-CARGO 170945.

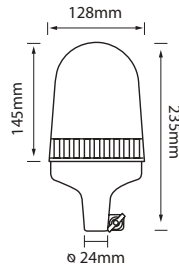

Voltage: 10-30

Height: 235 mm
Width: 128 mm

Bulb type: LED
Lens type: Polycarbonate
Colour: Orange
Material: Plastic/nylon/rubber
Model: 80 LEDs
Mount.: Standard ISO A - Rod
Base: Flexible
Flash patterns: 3
Tightness norm: IP 65
Approvals: ECE-R65
E-approval: Yes

172030 LED Beacon

Lens: HC-CARGO 170945. w/ battery.

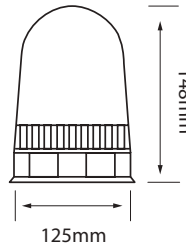

Voltage: 12
Amp: 1.5

Height: 148 mm
Dist. mount. holes: 107 mm
Width: 125 mm

Bulb type: LED
Lens type: Polycarbonate
Colour: Orange
Material: Plastic/nylon/rubber
Model: 80 LEDs
Mount.: Plan
Base: Magnetic/vacuum
Flash patterns: 3
Tightness norm: IP 65
Approvals: ECE-R65
E-approval: Yes

172075 LED Beacon UK Version

Servicing: UK

Lens: HC-CARGO 170945. With battery.

NEW PRODUCT
www.hc-cargo.com

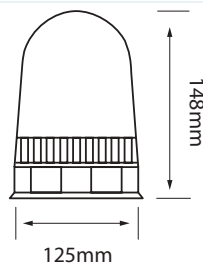

Voltage: 10-30

Height: 148 mm
Width: 125 mm

Bulb type: LED
Lens type: Polycarbonate
Colour: Orange
Material: Plastic/nylon/rubber
Model: 80 LEDs
Mount.: Plan
Base: Magnetic/vacuum
Flash patterns: 3
Tightness norm: IP 65
E-approval: Yes

SPARE PARTS

171941 Lens

Servicing: HC-CARGO 171918, 171919, 171920



Lens type: Polycarbonate
Colour: Orange

171942 Lens

Servicing: HC-CARGO 171921, 171922, 171923

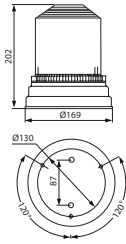

Lens type: Polycarbonate
Colour: Blue

ROTATING BEACONS XENON
170650 Xenon Beacon

Bulb incl.: Yes
Voltage: 12
Amp: 1.5

OD: 169 mm
Height: 202 mm

Bulb type: LX10J
Lens type: Polycarbonate
Colour: Orange
Model: XENON FT6 AG ELECTRONIC
Mount.: Standard ISO B2 (and B1) - Base
Hi impact: Yes
Tightness norm: IP 55
E-approval: Yes

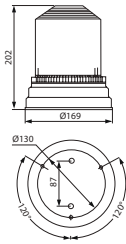
170651 Xenon Beacon

Bulb incl.: Yes
Voltage: 24
Amp: 1.5

OD: 169 mm
Height: 202 mm

Bulb type: LX10J
Lens type: PMMA/ACRYL
Colour: Orange
Model: XENON FT6 AG ELECTRONIC
Mount.: Standard ISO B2 (and B1) - Base
Tightness norm: IP 55
E-approval: Yes

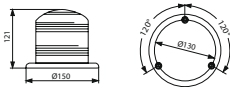
170680 Xenon Beacon

Bulb incl.: Yes
Voltage: 10-100
Amp: 200/50
mAmpere

OD: 150 mm
Height: 121 mm
Width: 150 mm

Bulb type: LX1J
Lens type: Polycarbonate
Colour: Orange
Material: Polycarbonate
Model: FLASH ELEV
Mount.: Standard ISO B2 (and B1) - Base
Base: Rigid
Hi impact: Yes
Tightness norm: IP 54
Approvals: CE/EMC

171005 Xenon Beacon

w/ Xenon tube. Lens: HC-CARGO 171590.

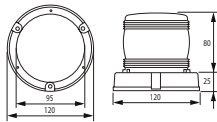

Bulb incl.: Yes
Voltage: 10-100

OD: 120 mm
Height: 105 mm

Bulb type: LX10J
Lens type: PMMA/ACRYL
Colour: Orange
Model: TYPE TRASPOT XENON
Mount.: Standard ISO B2 (and B1) - Base
Approvals: CE/EMC

171495 Xenon Beacon

Tested for 200 kmh. Lens: HC-CARGO 171512.

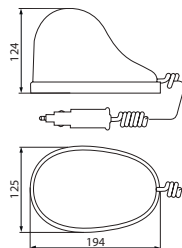

Bulb incl.: Yes
Voltage: 12
Amp: 1.5

OD: 120x186 mm
Length: 194 mm
Height: 124 mm
Width: 125 mm

Bulb type: LX8J
Lens type: Polycarbonate
Colour: Orange
Material: Rubber
Model: GDO FLASH
Mount.: 1 magnet
Base: Magnetic
Hi impact: Yes
Coiled cable incl.: Yes
Tightness norm: IP 55
Approvals: CE
E-approval: Yes

171497 Xenon Beacon

Tested for 200 kmh.

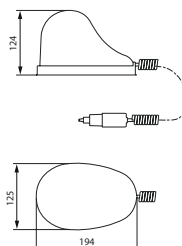

Bulb incl.: Yes
Voltage: 12
Amp: 1.5

OD: 120x186 mm
Length: 194 mm
Height: 124 mm
Width: 125 mm

Bulb type: LX8J
Lens type: Polycarbonate
Colour: Blue
Material: Rubber
Model: GDO FLASH
Mount.: 1 magnet
Base: Magnetic
Hi impact: Yes
Coiled cable incl.: Yes
Tightness norm: IP 55
Approvals: CE
E-approval: Yes

171498 Xenon Beacon

w/ built-in audible signal.

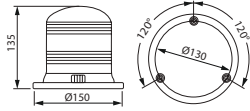

Bulb incl.: Yes
Voltage: 10-100
Amp: 200/50 mA

OD: 150 mm
Height: 135 mm
Width: 150 mm

Bulb type: LX1J
Lens type: Polycarbonate
Colour: Orange
Model: FLASH ELEV SL
Mount.: Standard ISO B2 (and B1) - Base
Hi impact: Yes
Tightness norm: IP 20

171505 Xenon Beacon

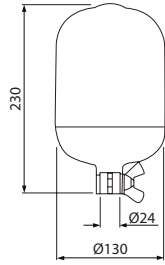

Bulb incl.: Yes
Voltage: 12
Amp: 3

OD: 130 mm
Height: 230 mm
Width: 130 mm

Bulb type: LX10J
Lens type: Polycarbonate
Colour: Orange
Model: XENON GF 8.8 FLASH
Mount.: Plan (ISO-DIN B)
Base: Rigid
Hi impact: Yes
Tightness norm: IP 44
Approvals: CE
E-approval: Yes

171540 Xenon Beacon

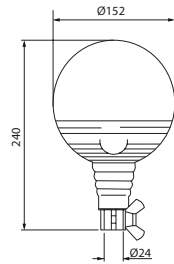

Bulb incl.: Yes
Voltage: 12
Amp: 1.5

OD: 152 mm
Height: 240 mm
Width: 152 mm

Bulb type: LX8J
Lens type: Polycarbonate
Colour: Orange
Model: BOULE FLASH
Mount.: Standard ISO A - Rod
Base: Flexible
Hi impact: Yes
Tightness norm: IP 66
E-approval: Yes

171541 Xenon Beacon

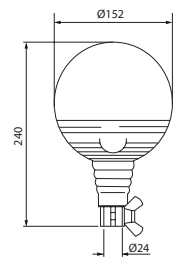

Bulb incl.: Yes
Voltage: 24
Amp: 1.5

OD: 152 mm
Height: 240 mm

Bulb type: LX8J
Lens type: Polycarbonate
Colour: Orange
Model: BOULE FLASH
Mount.: Standard ISO A - Rod
Base: Flexible
Hi impact: Yes
Tightness norm: IP 66
E-approval: Yes

171561 Xenon Beacon

w/ Xenon tube. Lens: HC-CARGO 171590.

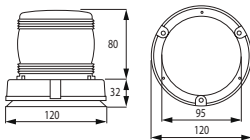

Voltage: 10-100

OD: 120 mm
Height: 112 mm
Width: 120 mm

Lens type: PMMA/ACRYL
Colour: Orange
Model: Type TRASPOT
Mount.: Standard ISO B2 (and B1) - Base
Base: Magnetic
Coiled cable incl.: Yes
Approvals: CE/EMC

171614 Xenon Beacon

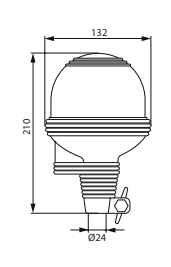

Bulb incl.: Yes
Voltage: 10-30

OD: 132 mm
Height: 210 mm

Bulb type: LX10J
Lens type: Polycarbonate
Colour: Orange
Model: Xenon
Mount.: Standard ISO A - Rod
Hi impact: Yes
E-approval: Yes

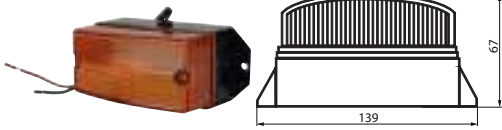
171708 Xenon Beacon

Bulb incl.: Yes
Voltage: 11-120
Amp: 0.2

Length: 139 mm
Height: 67 mm
Dist. mount. holes:
130 mm
Width: 67 mm

Bulb type: Xenon
Lens type: Polycarbonate
Flash rate: 72 min.
Colour: Orange
Mount.: Plan
Hi impact: Yes
Waterproof: Yes
Approvals: CE

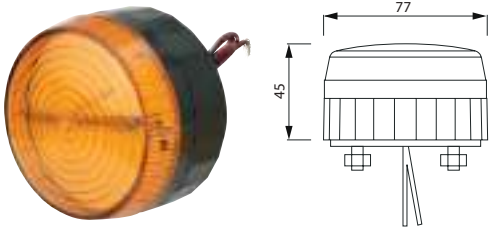
171798 Xenon Beacon

Voltage: 10-100
Watt: 5

OD: 77 mm
Height: 45 mm
Dist. mount. holes:
45 mm

Bulb type: Xenon
Lens type: Polycarbonate
Flash rate: 75 min.
Colour: Orange
Material: Polycarbonate
Mount.: Plan
Hi impact: Yes
Tightness norm: IP 67
Approvals: CE

SPARE PARTS
170654 Xenon Bulb

Servicing: HC-CARGO 170650, 170651, 171505, 171005



Voltage: 12/24
Watt: 16

Bulb type: LX10J
Model: XENON FT6 /FLX ELECTRONIC

171376 Xenon Bulb

Servicing: HC-CARGO 171498, 170680



Voltage: 10-100
Amp: 200/50 mA

Bulb type: LX1J
Model: FLASH ELEV

171590 Dome

Servicing: HC-CARGO 171005, 171561



Lens type: PMMA/ACRYL
Colour: Orange
Model: TRASPORT XENON

ACCESSORIES
170525 Beacon Socket

Servicing: HC-CARGO 170490, 171017



Cable length: 2000 mm
Height: 28 mm
Width: 147 mm

Model: TYPE FT 6
Mount.: 3 magnets
Base: Magnetic
Coiled cable incl.: Yes
Tightness norm: IP 55

170528 Base Plate

Servicing: HC-CARGO 170491, 170490, 170650, 170651, 171498, 170680

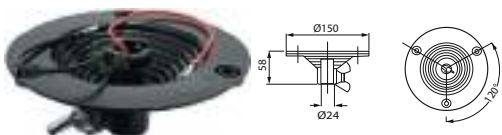

Height: 58 mm
Width: 150 mm

Model: TYPE FT 6
Mount.: Standard ISO A - Rod

170653 Beacon Socket

Servicing: HC-CARGO 170650, 170651, 171466



Cable length: 2000 mm
Height: 30 mm
Width: 168 mm

Mount.: 3 magnets
Base: Magnetic
Coiled cable incl.: Yes
Tightness norm: IP 55
E-approval: Yes

FLASH LIGHTS LED

171642 LED Flash, white

Multi-module synchronization. Bracket: HC-CARGO 171657. Rubber adapter for flush mount: HC-CARGO 171728.

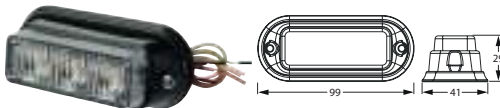

Voltage: 12/24

Length: 99 mm
Height: 29 mm
Width: 41 mm

Bulb type: LED
Colour: White
Model: 3 LED
Flash patterns: 12
Waterproof: Yes
Approvals: CE/EMC

171644 LED Flash, blue

Multi-module synchronization. Bracket: HC-CARGO 171657. Rubber adapter for flush mount: HC-CARGO 171728.

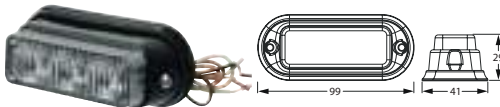

Voltage: 12/24

Length: 99 mm
Height: 29 mm
Width: 41 mm

Bulb type: LED
Colour: Blue
Model: 3 LED
Flash patterns: 12
Waterproof: Yes
Approvals: CE/EMC

171646 LED Flash, white

Multi-module synchronization. Bracket: HC-CARGO 171658. Rubber adapter for flush mount: HC-CARGO 171675.

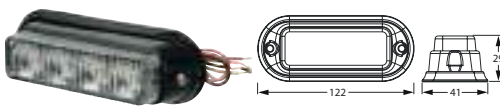

Voltage: 12/24

Length: 122 mm
Height: 29 mm
Width: 41 mm

Bulb type: LED
Colour: White
Model: 4 LED
Flash patterns: 19
Waterproof: Yes
Approvals: CE/EMC

171648 LED Flash, blue

Multi-module synchronization. Bracket: HC-CARGO 171658. Rubber adapter for flush mount: HC-CARGO 171675.

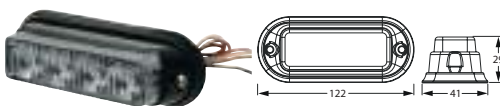

Voltage: 12/24

Length: 122 mm
Height: 29 mm
Width: 41 mm

Bulb type: LED
Colour: Blue
Model: 4 LED
Flash patterns: 19
Waterproof: Yes
Approvals: CE/EMC

171661 LED Flash, amber

Multi-module synchronization. Bracket: HC-CARGO 171663.



Voltage: 12/24

Length: 116 mm
Height: 23.8 mm
Width: 47 mm

Bulb type: LED
Lens type: Frosted
Colour: Orange
Model: 4 LED
Flash patterns: 12
Waterproof: Yes
Approvals: SAE/CE

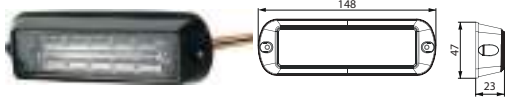
171662 LED Flash, amber
Multi-module synchronization. Bracket: HC-CARGO 171664.

Voltage: 12/24

 Length: 148 mm
 Height: 23 mm
 Width: 47 mm

 Bulb type: LED
 Lens type: Transparent
 Colour: Orange
 Model: 6 LED
 Flash patterns: 19
 Waterproof: Yes
 Approvals: SAE/CE

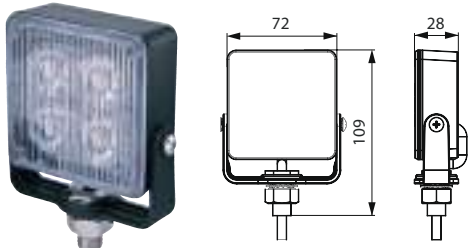
171746 LED Flash, amber

Voltage: 12/24

 Length: 109 mm
 Height: 28 mm
 Width: 72 mm

 Bulb type: LED
 Lens type: Transparent
 Colour: Orange
 Material: Cast aluminum
 Hi impact: Yes
 Coiled cable incl.: No
 Waterproof: Yes
 Approvals: CE

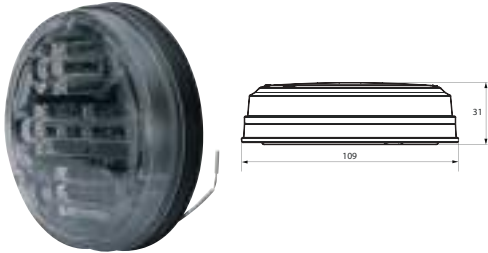
171765 LED Flash, amber
Rubber adapter for flush mount: HC-CARGO 171766.

Voltage: 12/24

 OD: 109 mm
 Height: 31 mm
 Width: 109 mm

 Bulb type: 10 LED
 Lens type: Polycarbonate
 Colour: Orange
 Mount.: Plan
 Hi impact: Yes
 Waterproof: Yes

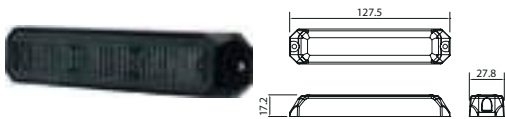
171813 LED Flash, blue
Fits w/ rubber adapter for flush mount: HC-CARGO 171817.

Voltage: 12/24

 Length: 127.5 mm
 Height: 17.2 mm
 Width: 27.8 mm

 Bulb type: LED
 Flash rate: 5 min.
 Colour: Blue
 Model: 6 LED
 Waterproof: Yes
 Approvals: SAE/ECE-R65
 E-approval: Yes

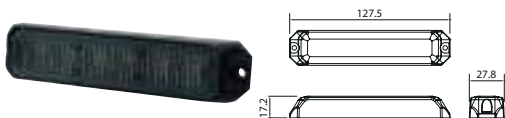
171814 LED Flash, amber
Fits w/ rubber adapter for flush mount: HC-CARGO 171817.

Voltage: 12/24

 Length: 127.5 mm
 Height: 17.2 mm
 Width: 27.8 mm

 Bulb type: LED
 Colour: Yellow
 Model: 6 LED
 Flash patterns: 5
 Waterproof: Yes
 Approvals: SAE/ECE-R65
 E-approval: Yes

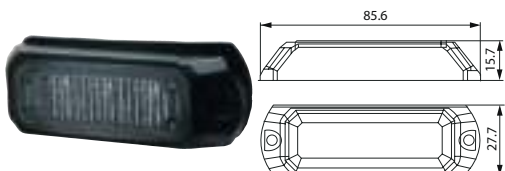
171815 LED Flash, yellow
For HC-CARGO 171816.

Voltage: 12/24

 Length: 85.6 mm
 Height: 15.7 mm
 Width: 27.7 mm

 Bulb type: LED
 Colour: Orange
 Model: 3 LED
 Flash patterns: 12
 Waterproof: Yes
 Approvals: SAE/ECE-R65
 E-approval: Yes

171904 LED Flash, amber

Multi-module synchronization. Bracket: HC-CARGO 171658. Rubber adapter for flush mount: HC-CARGO 171675.

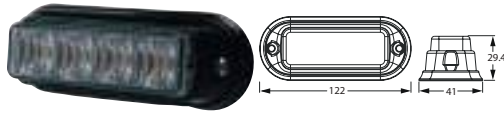

Voltage: 12-24

Length: 122 mm
Height: 29.4 mm
Width: 41 mm

Bulb type: LED
Colour: Orange
Model: 4 LED
Flash patterns: 19
Waterproof: Yes
Approvals: SAE/ECE-R65
E-approval: Yes

171905 LED Flash, amber

Multi-module synchronization. Bracket: HC-CARGO 171657. Rubber adapter for flush mount: HC-CARGO 171728.

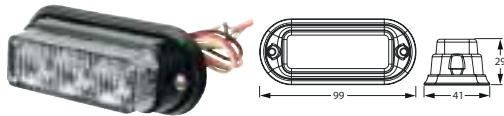

Voltage: 12-24

Length: 99 mm
Height: 29 mm
Width: 41 mm

Bulb type: LED
Colour: Orange
Model: 3 LED
Flash patterns: 12
Waterproof: Yes
Approvals: SAE/ECE-R65
E-approval: Yes

171906 LED Flash, amber

Multi-module synchronization. Bracket: HC-CARGO 171908. Rubber adapter for flush mount: HC-CARGO 171907.



Voltage: 12-24

Length: 131.8 mm
Height: 48.7 mm
Width: 19.2 mm

Bulb type: LED
Colour: Orange
Model: 12 LED
Flash patterns: 25
Waterproof: Yes
Approvals: SAE/ECE-R65
E-approval: Yes

171926 LED Flash, amber

Fits w/ rubber adapter for flush mount: HC-CARGO 171817.

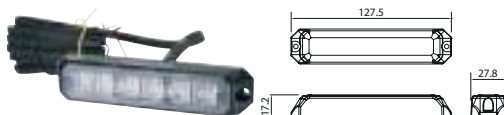

Voltage: 12-24

Length: 127.5 mm
Cable length: 2000 mm
Height: 17.2 mm
Width: 27.8 mm

Bulb type: LED
Colour: Yellow
Model: 6 LED
Mount.: 3 m ADR Cable
Waterproof: Yes
Approvals: SAE/ECE-R65
E-approval: Yes

171933 LED Flash, amber

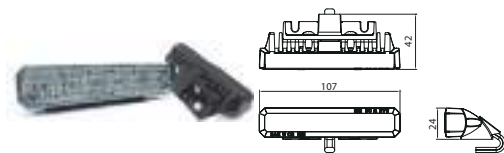

Voltage: 11-30

Length: 107 mm
Height: 24 mm
Width: 42 mm

Bulb type: LED
Colour: Yellow
Model: 6 LED
Mount.: Plan
Flash patterns: 5
Waterproof: Yes
Approvals: SAE/ECE-R65
E-approval: Yes

171934 LED Flash, blue

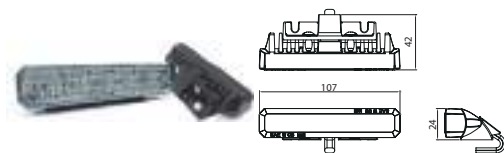

Voltage: 11-30

Length: 107 mm
Height: 24 mm
Width: 42 mm

Bulb type: LED
Colour: Blue
Model: 6 LED
Mount.: Plan
Flash patterns: 5
Waterproof: Yes
Approvals: SAE/ECE-R65
E-approval: Yes

171943 LED Flash, white

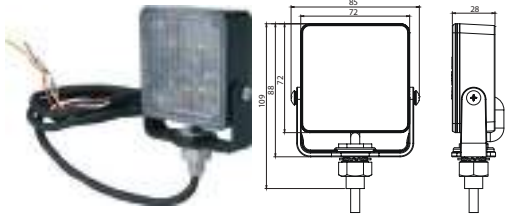

Voltage: 12/24
Amp: 0.27-0.13
Watt: 3.5

Length: 109 mm
Cable length: 1200 mm
Height: 28 mm
Width: 72 mm

Bulb type: LED
Lens type: Transparent
Colour: White
Material: Aluminium
Hi impact: Yes
Coiled cable incl.: No
Waterproof: Yes
Approvals: SAE/CE

172011 LED Flash, amber

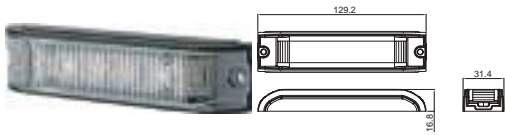

Voltage: 12/24
Watt: 12

Length: 129.2 mm
Height: 31.4 mm
Width: 16.8 mm

Colour: Orange
Model: 6 LED
Flash patterns: 15
Approvals: ECE-R65
E-approval: Yes

172012 LED Flash, amber

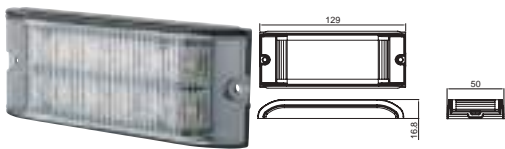

Voltage: 12/24
Watt: 21

Length: 129 mm
Height: 16.8 mm
Width: 50 mm

Bulb type: LED
Colour: Orange
Model: 12 LED
Flash patterns: 15
Approvals: ECE-R65
E-approval: Yes

172013 LED Flash, amber

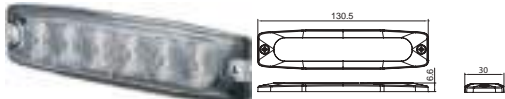

Voltage: 12/24
Watt: 6

Length: 130.5 mm
Height: 6.6 mm
Width: 30 mm

Colour: Orange
Model: 6 LED
Flash patterns: 23
Approvals: SAE/CE

ACCESSORIES

171657 Mounting Bracket

Servicing: HC-CARGO 171641, 171642, 171644

Angled. For single head.



Length: 100 mm
Thickness: 24 mm
Width: 55 mm

171658 Mounting Bracket

Servicing: HC-CARGO 171646, 171648

Angled. For single head.



Length: 123 mm
Thickness: 55 mm
Width: 24 mm

171663 Mounting Bracket

Servicing: HC-CARGO 171661

Angled 100°.



Length: 153 mm
Thickness: 55 mm
Width: 25 mm

EL. SPECIFICATIONS		DIMENSIONS	ADDITIONAL SPECIFICATIONS
171664 Mounting Bracket <i>Adjustable.</i>		Servicing: HC-CARGO 171662 Length: 156 mm Thickness: 42 mm Width: 30 mm	
171675 Rubber Adapter for Flush Mount		Servicing: HC-CARGO 171646, 171648 Length: 114.4 mm Height: 24.9 mm Width: 40 mm Colour: Black Material: Rubber	
171728 Rubber Adapter for Flush Mount		Servicing: HC-CARGO 171641, 171642, 171644 Length: 92 mm Height: 25.2 mm Width: 40 mm Colour: Black Material: Rubber	
171766 Rubber Boot <i>For flush mount of HC-CARGO 171765.</i>		Servicing: HC-CARGO 171765 Material: Rubber	
171816 Rubber Adapter for Flush Mount		Servicing: HC-CARGO 171815 Length: 100.6 mm Height: 15.7 mm Width: 38 mm Colour: Black Material: Rubber	
171817 Rubber Adapter for Flush Mount		Servicing: HC-CARGO 171813, 171814 Length: 142 mm Height: 17.5 mm Width: 41 mm Colour: Black Material: Rubber	
171907 Rubber Adapter for Flush Mount		Servicing: HC-CARGO 171906 Length: 144 mm Height: 61 mm Width: 20 mm Colour: Black Material: Rubber	

171908 Mounting Bracket

Servicing: HC-CARGO 171906

Angled. For single head.

LIGHT BARS CONVENTIONAL
171681 Mini Light Bar

 Bulb incl.: Yes
 12 V
 Voltage: 12/24

 Length: 400 mm
 Height: 134 mm
 Width: 180 mm

 Bulb type: H1 12 V
 Lens type: Polycarbonate
 Colour: Orange
 Material: ABS plastic
 Mount.: Plan
 Base: Rigid
 Hi impact: Yes
 Waterproof: Yes
 Tightness norm: IP 56
 Approvals: CE
 E-approval: Yes

SPARE PARTS
171820 Belt for Mini Light Bar

Servicing: HC-CARGO 171681



Colour: Black

LIGHT BARS LED
171680 LED Mini Light Bar

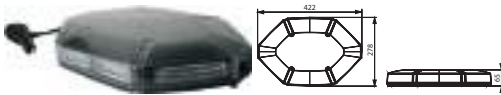
Bracket for permanent mounting: HC-CARGO 171682. Change flash pattern on cigarplug. Can also be connected permanently.

Voltage: 12/24

 Length: 422 mm
 Cable length: 3000 mm
 Height: 65 mm
 Width: 278 mm

 Bulb type: 40x1W LED
 Lens type: Polycarbonate
 Colour: Orange
 Model: FALCON
 Mount.: Plan
 Base: Magnetic/vacuum
 Hi impact: Yes
 Waterproof: Yes
 Tightness norm: IP 66
 Approvals: SAE/CE

171760 LED Light bar

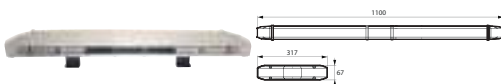
Spare Parts: HC-CARGO 171778. Accessories: HC-CARGO 171777, 171779, 171780, 171781, 171762.

 Voltage: 12
 Amp: 11.2

 Length: 1100 mm
 Height: 67 mm
 Width: 317 mm

 Lens type: Polycarbonate
 Colour: Orange
 Material: Aluminium
 Model: 110 cm/44"
 Mount.: Plan
 Base: Flexible
 Hi impact: Yes
 Waterproof: Yes
 Approvals: SAE/CE

171761 LED Light bar

Spare Parts: HC-CARGO 171778. Accessories: HC-CARGO 171777, 171779, 171780, 171781, 171762.

 Voltage: 12
 Amp: 11.2

 Length: 1470 mm
 Height: 67 mm
 Width: 317 mm

 Lens type: Polycarbonate
 Colour: Orange
 Material: Aluminium
 Model: 147 cm/59"
 Mount.: Plan
 Base: Flexible
 Hi impact: Yes
 Waterproof: Yes
 Approvals: SAE/CE

171849 LED Light bar

Spare Parts: HC-CARGO 171856, 171858. Accessories: HC-CARGO 171781, 171762. Recommended fuse 15 A.

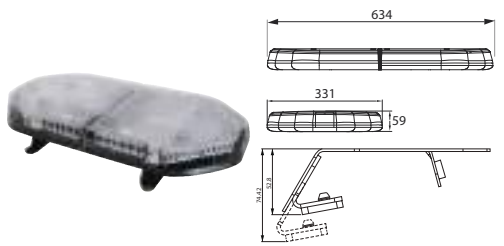

Voltage: 12
Amp: 10.4

Length: 634 mm
Height: 59 mm
Width: 331 mm

Lens type: Polycarbonate
Colour: Orange
Material: Aluminium
Model: 65 cm/24"
Mount.: Plan
Base: Flexible
Hi impact: Yes
Waterproof: Yes
Approvals: SAE/ECE-R65
E-approval: Yes

171850 LED Light bar

Spare Parts: HC-CARGO 171856, 171858. Accessories: HC-CARGO 171781, 171762. Recommended fuse 20 A.

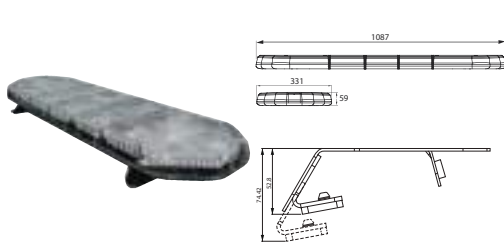

Voltage: 12
Amp: 13.4

Length: 1087 mm
Height: 59 mm
Width: 331 mm

Lens type: Polycarbonate
Colour: Orange
Material: Aluminium
Model: 110 cm/43"
Mount.: Plan
Base: Flexible
Hi impact: Yes
Waterproof: Yes
Approvals: SAE/ECE-R65
E-approval: Yes

171851 LED Light bar

Spare Parts: HC-CARGO 171857, 171859. Accessories: HC-CARGO 171865, 171762. Recommended fuse 15 A.

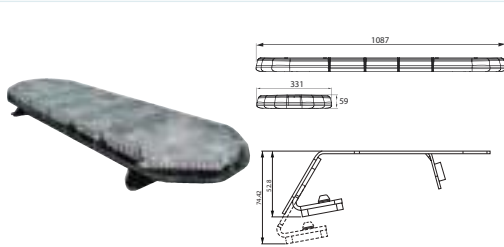

Voltage: 24
Amp: 8.2

Length: 1087 mm
Height: 59 mm
Width: 331 mm

Lens type: Polycarbonate
Colour: Orange
Material: Aluminium
Model: 110 cm/43"
Mount.: Plan
Base: Flexible
Hi impact: Yes
Waterproof: Yes
Approvals: SAE/ECE-R65
E-approval: Yes

171852 LED Light bar

Spare Parts: HC-CARGO 171856, 171858. Accessories: HC-CARGO 171781, 171762. Recommended fuse 25 A.

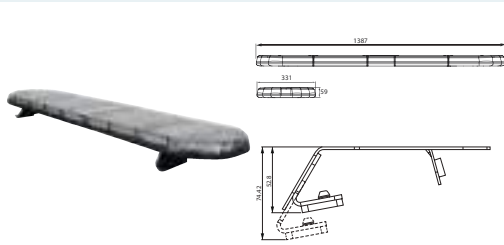

Voltage: 12
Amp: 16.2

Length: 1387 mm
Height: 59 mm
Width: 331 mm

Lens type: Polycarbonate
Colour: Orange
Material: Aluminium
Model: 140 cm/54"
Mount.: Plan
Base: Flexible
Hi impact: Yes
Waterproof: Yes
Approvals: SAE/ECE-R65
E-approval: Yes

171853 LED Light bar

Spare Parts: HC-CARGO 171857, 171859. Accessories: HC-CARGO 171865, 171762. Recommended fuse 15 A.

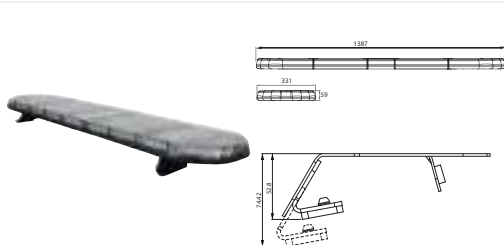

Voltage: 24
Amp: 10.2

Length: 1387 mm
Height: 59 mm
Width: 331 mm

Lens type: Polycarbonate
Colour: Orange
Material: Aluminium
Model: 140 cm/54"
Mount.: Plan
Base: Flexible
Hi impact: Yes
Waterproof: Yes
Approvals: SAE/ECE-R65
E-approval: Yes

171854 LED Micro Light Bar

Bracket for permanent mounting: HC-CARGO 171855. Change flash pattern on cigarplug. Can also be connected permanently.



Voltage: 12/24
Amp: 4.2/1.05

OD: 248x172 mm
Length: 248 mm
Height: 37 mm
Width: 172 mm

Bulb type: 30x1 W LED
Lens type: Polycarbonate
Colour: Orange
Mount.: Plan
Base: Magnetic
Flash patterns: 23
Waterproof: Yes
Approvals: SAE/ECE-R65
E-approval: Yes

171909 LED Light bar

Spare Parts: HC-CARGO 171915, 171916. Accessories: HC-CARGO 171781, 171762. Recommended fuse 25 A.

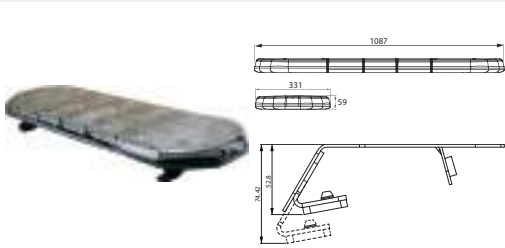

Voltage: 12
Amp: 16.4

Length: 1087 mm
Height: 59 mm
Width: 331 mm

Lens type: Polycarbonate
Colour: Blue
Material: Aluminium
Model: 110 cm/43"
Mount.: Plan
Base: Flexible
Hi impact: Yes
Waterproof: Yes
Approvals: SAE/ECE-R65
E-approval: Yes

171911 LED Light bar

Spare Parts: HC-CARGO 171857, 171859. Accessories: HC-CARGO 171865, 171762. Recommended fuse 15 A.

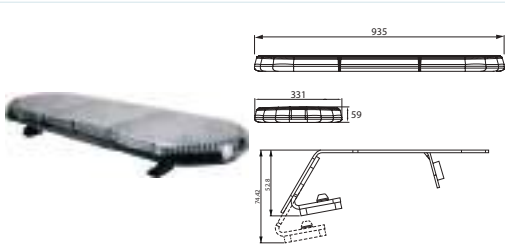

Voltage: 24
Amp: 7.2

Length: 935 mm
Height: 59 mm
Width: 331 mm

Lens type: Polycarbonate
Colour: Orange
Material: Aluminium
Model: 91.4cm - 36"
Mount.: Plan
Base: Flexible
Hi impact: Yes
Waterproof: Yes
Approvals: SAE/ECE-R65
E-approval: Yes

171912 LED Light bar

Spare Parts: HC-CARGO 171856, 171858. Accessories: HC-CARGO 171781, 171762. Recommended fuse 25 A.

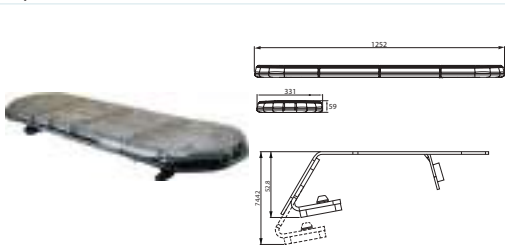

Voltage: 12
Amp: 14.8

Length: 1252 mm
Height: 59 mm
Width: 331 mm

Lens type: Polycarbonate
Colour: Orange
Material: Aluminium
Model: 124.5 cm/49"
Mount.: Plan
Base: Flexible
Hi impact: Yes
Waterproof: Yes
Approvals: SAE/ECE-R65
E-approval: Yes

171913 LED Light bar

Spare Parts: HC-CARGO 171857, 171859. Accessories: HC-CARGO 171865, 171762. Recommended fuse 15 A.



Voltage: 24
Amp: 9.2

Length: 1252 mm
Height: 59 mm
Width: 331 mm

Lens type: Polycarbonate
Colour: Orange
Material: Aluminium
Model: 124.5 cm/49"
Mount.: Plan
Base: Flexible
Hi impact: Yes
Waterproof: Yes
Approvals: SAE/ECE-R65
E-approval: Yes

171914 LED Light bar

Spare Parts: HC-CARGO 171857, 171859. Accessories: HC-CARGO 171865, 171762. Recommended fuse 20 A.

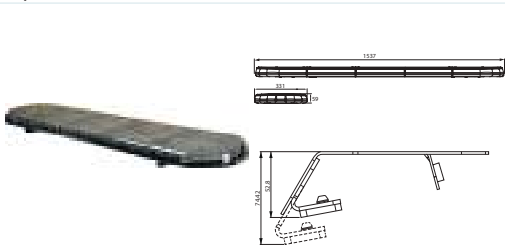

Voltage: 24
Amp: 11.2

Length: 1524 mm
Height: 59 mm
Width: 331 mm

Lens type: Polycarbonate
Colour: Orange
Material: Aluminium
Model: 152.4 cm/60"
Mount.: Plan
Base: Flexible
Hi impact: Yes
Waterproof: Yes
Approvals: SAE/ECE-R65
E-approval: Yes

ACCESSORIES

171682 Mounting Bracket for LED Mini Light Bar

Servicing: HC-CARGO 171680



Thickness: 3 mm
Dist. mount. holes:
212 mm

171762 Switch Panel Dim: 134x39x23 mm.		Servicing: HC-CARGO 171760, 171761, 171849, 171850, 171851, 171852, 171853, 171909, 171910, 171911, 171912, 171913, 171914	
		Mount. hole size: 4 mm	Type/terminal: Flat Colour: Black Button colour: Black Material: Metal Switch: S1-S4 On/Off, S5 Shift
171777 LED Flash, amber		Servicing: HC-CARGO 171760, 171761	
	Voltage: 12	Length: 119.9 mm Height: 39.9 mm Width: 18.8 mm	Bulb type: 6 LED Colour: Orange
171778 LED Corner Flash, orange		Servicing: HC-CARGO 171760, 171761	
	Voltage: 12	Length: 166 mm Height: 37 mm Width: 18.8 mm	Bulb type: 12 LED Colour: Orange
171779 LED Work Lamp		Servicing: HC-CARGO 171760, 170761	
	Voltage: 12	Length: 119.9 mm Height: 37 mm Width: 17.8 mm	Bulb type: 6 LED Colour: Transparent
171780 LED Work Lamp		Servicing: HC-CARGO 171760, 171761	
	Voltage: 12	Length: 119.9 mm Height: 37 mm Width: 17.8 mm	Bulb type: 9 LED Colour: Transparent
171781 LED Alley light		Servicing: HC-CARGO 171760, 171761, 171749, 171850, 171852, 171909, 171910, 171913	
	Voltage: 12	Length: 38 mm Height: 39.2 mm Width: 18.1 mm	Bulb type: 3 LED Colour: Transparent Approvals: SAE/ECE-R65 E-approval: Yes
171855 Mounting Bracket for LED Micro Light Bar		Servicing: HC-CARGO 171854	
		Total length: 203.9 mm Height: 14 mm Dist. mount. holes: 64/184 mm Width: 35 mm	

EL. SPECIFICATIONS		DIMENSIONS		ADDITIONAL SPECIFICATIONS	
171856 LED Flash, amber 		Servicing: HC-CARGO 171760, 171761, 171849, 171850, 171852, 171910, 171912 Voltage: 12 Length: 120 mm Height: 36.75 mm Width: 18.78 mm		Bulb type: 6 LED Colour: Orange Approvals: SAE/ECE-R65 E-approval: Yes	
171857 LED Flash, amber 		Servicing: HC-CARGO 171851, 171853, 171911, 171913, 171914 Voltage: 24 Length: 120 mm Height: 36.75 mm Width: 18.78 mm		Bulb type: 6 LED Colour: Orange Approvals: SAE/ECE-R65 E-approval: Yes	
171858 LED Corner Flash, orange 		Servicing: HC-CARGO 171760, 171761, 171849, 171850, 171852, 171910, 171912 Voltage: 12 Length: 164 mm Height: 33 mm Width: 28.28 mm		Bulb type: 12 LED Colour: Orange Approvals: SAE/ECE-R65 E-approval: Yes	
171859 LED Corner Flash, orange 		Servicing: HC-CARGO 171851, 171853, 171911, 171913, 171914 Voltage: 24 Length: 164 mm Height: 33 mm Width: 28.28 mm		Bulb type: 12 LED Colour: Orange Approvals: SAE/ECE-R65 E-approval: Yes	
171865 LED Alley light 		Servicing: HC-CARGO 171851, 171853, 171911, 171913, 171914 Voltage: 24 Height: 38.41 mm		Bulb type: 3 LED Approvals: SAE/ECE-R65 E-approval: Yes	
171915 LED Flash, blue 		Servicing: HC-CARGO 171909 Voltage: 12 Length: 120 mm Height: 36.75 mm Width: 18.78 mm		Bulb type: 6 LED Colour: Blue Approvals: SAE/ECE-R65 E-approval: Yes	
171916 LED Corner Flash 		Servicing: HC-CARGO 171909 Voltage: 12 Length: 164 mm Height: 33 mm Width: 28.28 mm		Bulb type: 12 LED Colour: Blue Approvals: SAE/ECE-R65 E-approval: Yes	

BEACON SOCKETS			
170292 Beacon Socket			
		Length: 100 mm	Material: Steel Mount.: Weld Bracket: Straight Socket: DIN 72591 1 terminal
170387 Beacon Socket			
			Material: Electro galvanized Mount.: w/ nuts Bracket: Straight Socket: DIN 72591 1 terminal
170405 Beacon Socket			
		Length: 108 mm Mount. hole size: 10 mm	Material: Galvanised steel Mount.: Flat Bracket: Angled 90° Socket: DIN 72591 2 terminal
170406 Beacon Socket			
			Material: Galvanised steel Mount.: 2 screws Bracket: Adjustable Socket: DIN 72591 2 terminal
170419 Beacon Socket			
			Material: Galvanised steel Mount.: Vertical Bracket: Angled 90° Socket: DIN 72591 2 terminal
170531 Extension			
		Length: 500 mm Mount. hole size: 24 mm	Material: Galvanised steel Bracket: Straight Socket: DIN 72591 2 terminal
170537 Beacon Socket			
			Material: Electro galvanized Mount.: Vertical Bracket: Straight Socket: DIN 72591 2 terminal

170562 Beacon Socket

Material: Galvanised steel
Mount.: 2 screws
Bracket: Angled 90°
Socket: DIN 72591 2 terminal

170788 Beacon Socket

Length: 102 mm
Mount. hole size:
 10 mm

Material: Electro galvanized
Mount.: Flat
Bracket: Angled
Socket: DIN 72591 1 terminal

170789 Beacon Socket

Material: Electro galvanized
Bracket: Flexible
Mount.: Vertical
Socket: DIN 72591 1 terminal

171576 Beacon Socket

Servicing: IH/CASE



Material: Steel
Mount.: Vertical
Bracket: Straight
Socket: DIN 72591 2 terminal

SPARE PARTS
170460 Beacon Socket

Servicing: John Deere tractor etc



Material: Galvanised steel
Mount.: 1 bolt
Bracket: Angled
Socket: DIN 72591 2 terminal

171513 Rubber Body for Beacon Socket

Servicing: HC-CARGO 170292, 170387, 170405, 170788, 170406, 170562, 170789, 170537, 171576, 170419, 170460











Material: Rubber

171518 Coiled Cable

Servicing: HC-CARGO 170292, 170387, 170405, 170788, 170406, 170562, 170789, 170537, 171576, 170419, 170460

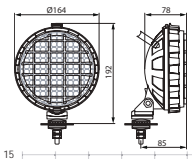
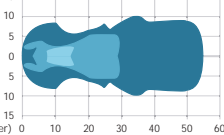

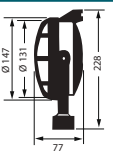
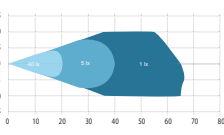
Plug type: Cigar plug
Plug 1: 2
ISO norm: 4165

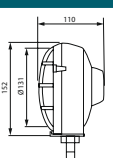
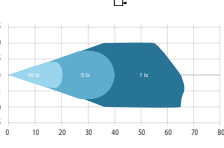
EL. SPECIFICATIONS	DIMENSIONS	ADDITIONAL SPECIFICATIONS	
<p>171562 Coiled Cable Servicing: HC-CARGO 171763, 171764, 171494, 171495, 171496</p>			
		<p>Plug type: Cigar plug</p>	
<p>180376 DIN Socket Servicing: HC-CARGO 170292, 170387, 170405, 170788, 170406, 170562, 170789, 170537, 171576, 170419, 170460</p>			
<p><i>Also used in sockets for beacons.</i></p>			
		<p>Material: Brass No./poles: 1</p>	
<p>180377 DIN Socket</p>			
<p><i>Also used in sockets for beacons.</i></p>			
		<p>Material: Brass No./poles: 2</p>	
<h2 style="text-align: center;">WORK LAMPS CONVENTIONAL</h2>			
<p>170093 Work Lamp</p>			
  	<p>Bulb incl.: No</p>	<p>Dim.: 164x192x85 mm Light aperture: 136 mm</p>	<p>Bulb type: H3 Socket type: PK22s Colour: Black Material/dome: Glass Material/house: Plastic Reflector system: Single Shape: Round Switch: w/ Mount. bracket: Single bolt fixing Grill: w/ Handle: w/</p>
<p>170237 Work Lamp</p>			
  	<p>Bulb incl.: No</p>	<p>Dim.: 228x77 mm Light aperture: 131 mm</p>	<p>Bulb type: H3 Socket type: PK22s Colour: Black Material/dome: Glass Material/house: Shockproof plastic Reflector system: Single Shape: Round Switch: w/ Mount. bracket: U-bracket w/ 2 holes Grill: w/ Handle: w/</p>
<p>170313 Work Lamp</p>			
  	<p>Bulb incl.: No</p>	<p>Dim.: 152x110 mm Light aperture: 131 mm</p>	<p>Bulb type: H3 Socket type: PK22s Colour: Black Material/dome: Glass Material/house: Shockproof plastic Reflector system: Single Shape: Round Mount. bracket: Single bolt fixing Grill: w/</p>

170488 Work Lamp

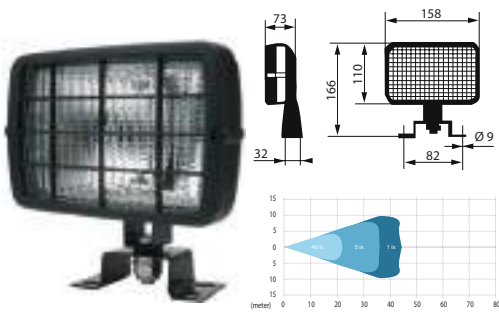

Bulb incl.: No

Dim.: 166x158x73 mm
Light aperture:
155x104 mm

Bulb type: H3
Socket type: PK22s
Colour: Black
Material/dome: Glass
Material/house: Shockproof plastic
Reflector system: Single
Shape: Rectangular
Mount. bracket: U-bracket w/ 4 holes
Grill: w/

170489 Work Lamp

w/o U-bracket.

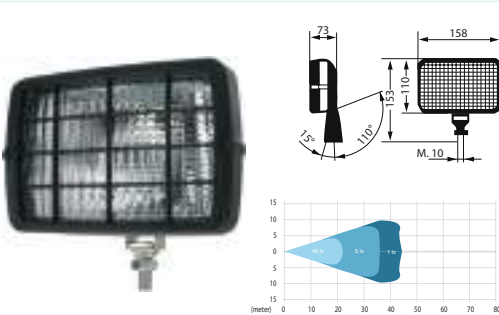

Bulb incl.: No

Dim.: 158x153x73 mm
Light aperture:
155x104 mm

Bulb type: H3
Socket type: PK22s
Colour: Black
Material/dome: Glass
Material/house: Shockproof plastic
Reflector system: Single
Shape: Rectangular
Mount. bracket: Single bolt fixing
Grill: w/

170534 Work Lamp

Bracket: HC-CARGO 171936.

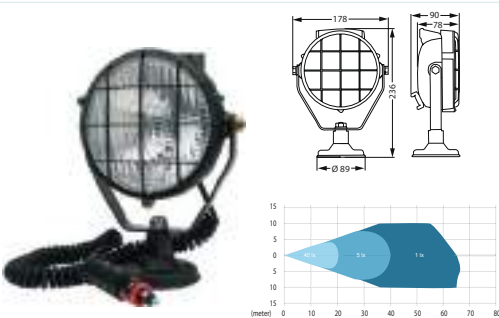

Bulb incl.: No

Dim.: 178x236x90 mm
Coiled cable: 2000 mm
Light aperture: 130 mm

Bulb type: H3
Socket type: PK22s
Colour: Black
Material/dome: Glass
Material/house: Metal
Shape: Round
Switch: w/
Grill: w/
Magnet base: w/
Lighter plug incl.: Yes
Handle: w/
Coiled cable incl.: Yes

170851 Work Lamp

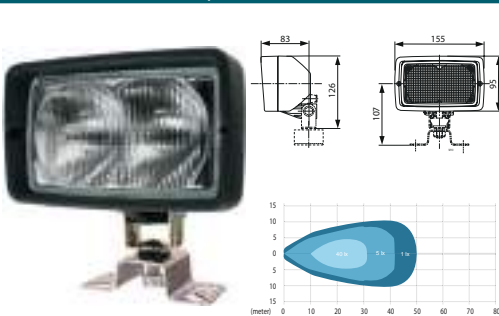

Bulb incl.: No

Dim.: 155x95x83 mm
Light aperture:
136x88 mm

Bulb type: H3
Socket type: PK22s
Colour: Black
Material/dome: Glass
Material/house: Shockproof plastic
Reflector system: Dual
Shape: Rectangular
Mount. bracket: U-bracket w/ 6 holes
Tightness norm: IP 54

170857 Work Lamp

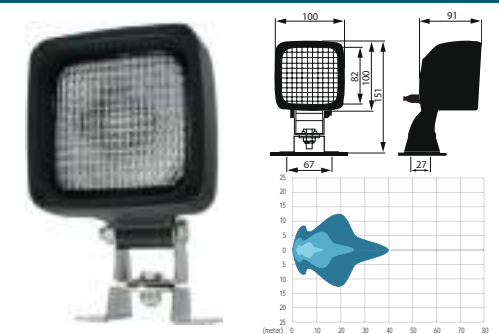

Bulb incl.: No

Dim.: 100x151x91 mm
Light aperture:
73x73 mm

Bulb type: H3
Socket type: PK22s
Colour: Black
Material/dome: Glass
Material/house: Shockproof plastic
Reflector system: Free form
Shape: Square
Mount.: Upright/pendant
Mount. bracket: U-bracket w/ 4 holes
2 poles: w/
Tightness norm: IP 66

170859 Work Lamp

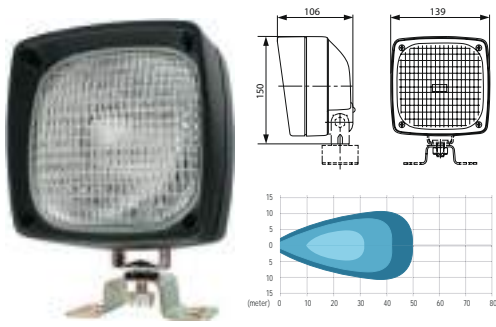

Bulb incl.: No

Dim.: 139x150x106 mm
Light aperture:
123x123 mm

Bulb type: H3
Socket type: PK22s
Colour: Black
Material/dome: Glass
Material/house: Shockproof plastic
Reflector system: Free form
Shape: Square
Mount. bracket: U-bracket w/ 6 holes

170970 Work Lamp

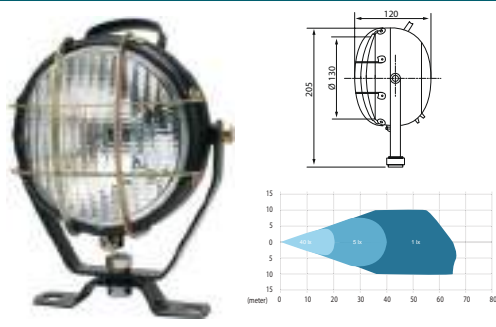

Bulb incl.: No

Dim.: 205x120 mm
Light aperture: 130 mm

Bulb type: H3
Socket type: PK22s
Colour: Black
Material/dome: Glass
Material/house: Metal
Shape: Round
Switch: w/
Mount. bracket: U-bracket w/ 2 holes
Grill: w/
Handle: w/

170979 Work Lamp

External plug for flat plug connection.

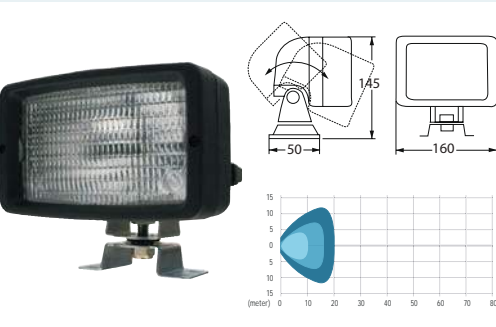

Bulb incl.: No

Dim.: 160x145x50 mm
Light aperture:
123x72 mm

Bulb type: H3
Socket type: PK22s
Colour: Black
Material/dome: Glass
Material/house: Shockproof plastic
Shape: Rectangular
Mount.: Flat
Mount. bracket: U-bracket w/ 4 holes

170980 Work Lamp

Servicing: Universal

External plug for flat plug connection.

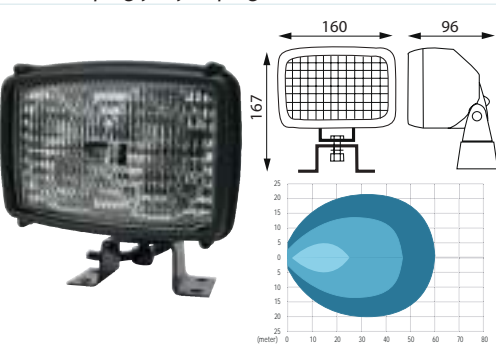

Bulb incl.: No

Dim.: 160x167x96 mm
Light aperture:
123x78 mm

Bulb type: H3
Socket type: PK22s
Colour: Black
Material/dome: Glass
Material/house: Shockproof plastic
Reflector system: Dual
Shape: Rectangular
Mount.: Flat
Mount. bracket: U-bracket w/ 4 holes
Tightness norm: IP 65

170981 Work Lamp

External plug for flat plug connection.

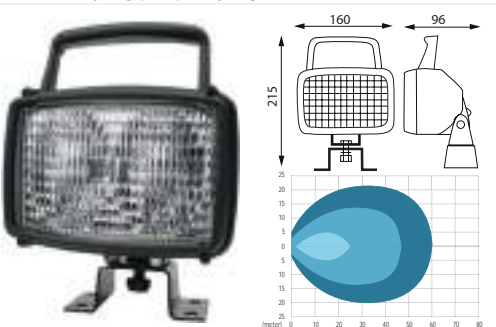

Bulb incl.: No

Dim.: 160x215x96 mm
Light aperture:
123x78 mm

Bulb type: H3
Socket type: PK22s
Colour: Black
Material/dome: Glass
Material/house: Shockproof plastic
Reflector system: Dual
Shape: Rectangular
Mount.: Flat
Switch: w/
Mount. bracket: U-bracket w/ 4 holes
Handle: w/
Tightness norm: IP 65

170982 Work Lamp

External plug for 6.3 mm flat plug connection.

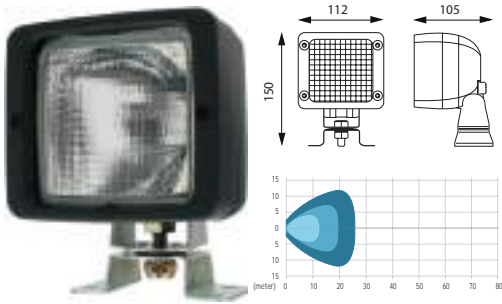

Bulb incl.: No

Dim.: 112x150x105 mm
Light aperture:
73x73 mm

Bulb type: H3
Socket type: PK22s
Colour: Black
Material/dome: Glass
Material/house: Shockproof plastic
Reflector system: Single
Shape: Square
Mount.: Flat
Mount. bracket: U-bracket w/ 4 holes
Tightness norm: IP 67

170983 Work Lamp

External plug for 6.3 mm flat plug connection.

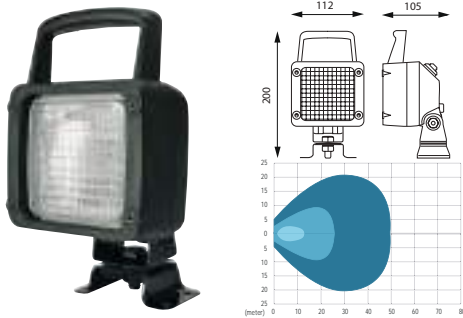

Bulb incl.: No

Dim.: 112x200x105 mm
Light aperture:
73x73 mm

Bulb type: H3
Socket type: PK22s
Colour: Black
Material/dome: Glass
Material/house: Shockproof plastic
Reflector system: Single
Shape: Square
Mount.: Flat
Switch: w/
Mount. bracket: U-bracket w/ 4 holes
Handle: w/
Tightness norm: IP 65

170984 Work Lamp

External plug for 6.3 mm flat plug connection.

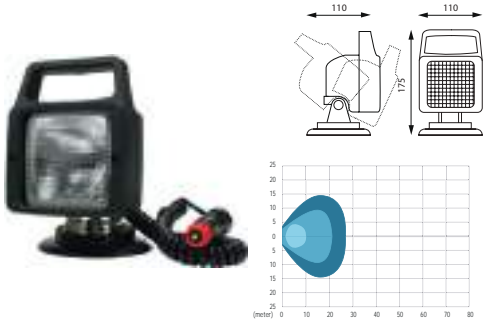

Bulb incl.: No

Dim.: 110x175x110 mm
Coiled cable: 2000 mm
Light aperture:
73x73 mm

Bulb type: H3
Socket type: PK22s
Colour: Black
Material/dome: Glass
Material/house: Shockproof plastic
Reflector system: Single
Shape: Square
Switch: w/
Magnet base: w/
Lighter plug incl.: Yes
Handle: w/
2 poles: w/
Coiled cable incl.: Yes

171167 Work Lamp

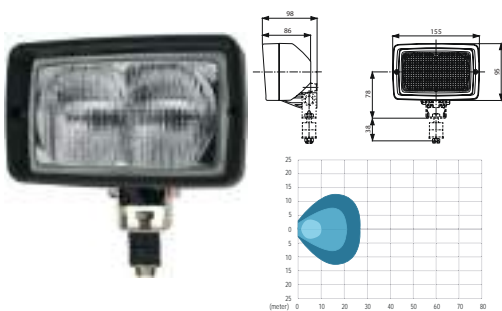

Bulb incl.: No

Dim.: 155x95x86 mm
Light aperture:
136x88 mm

Bulb type: H3
Socket type: PK22s
Colour: Black
Material/dome: Glass
Material/house: Shockproof plastic
Reflector system: Dual
Shape: Rectangular
Mount. bracket: U-bracket w/ 6 holes
Tightness norm: IP 54

171168 Work Lamp

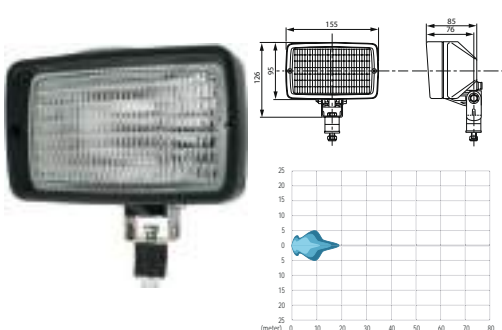

Bulb incl.: No

Dim.: 155x126x85 mm
Light aperture:
123x72 mm

Bulb type: H3
Socket type: PK22s
Inclination/downwards: 40°
Inclination/upwards: 100°
Colour: Black
Material/dome: Glass
Material/house: Shockproof plastic
Reflector system: Single
Shape: Rectangular

171347 Work Lamp

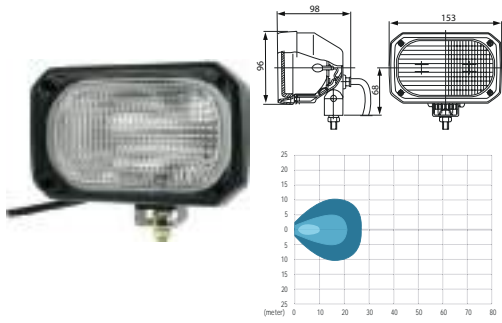

Bulb incl.: No

Dim.: 153x96x98 mm
Light aperture:
124x72 mm

Bulb type: H3
Socket type: PK22s
Colour: Black
Material/dome: Glass
Material/house: Shockproof plastic
Reflector system: Single
Shape: Rectangular
Mount.: Upright/pendant
Mount. bracket: Single bolt fixing

171449 Work Lamp

External plug for multipug connection.

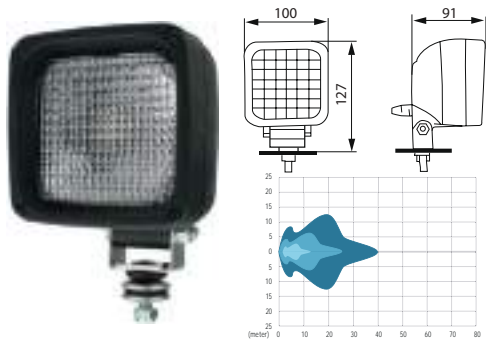

Bulb incl.: No
Watt: 55

Dim.: 100x127x91 mm
Light aperture:
73x73 mm

Bulb type: H3
Socket type: PK22s
Colour: Black
Material/dome: Shockproof plastic
Material/house: Glass
Reflector system: Single
Shape: Square
Mount.: Upright/pendant
Mount. bracket: Single bolt fixing
2 poles: w/
Tightness norm: IP 66

171564 Work Lamp

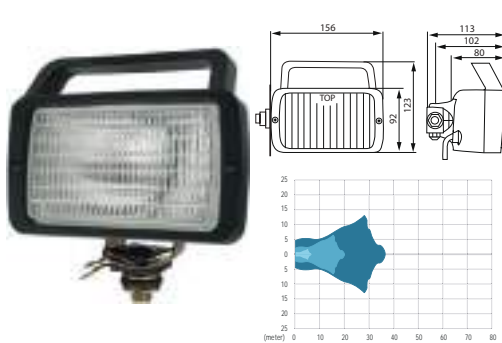

Bulb incl.: No

Dim.: 156x117x85 mm
Light aperture:
120x68 mm

Bulb type: H3
Socket type: PK22s
Material/dome: Shockproof plastic
Material/house: Glass
Shape: Rectangular
Switch: w/
Handle: w/
Tightness norm: IP 55

171566 Work Lamp

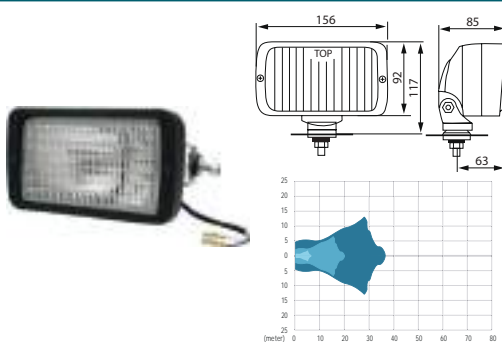

Bulb incl.: No

Dim.: 156x123x113 mm
Light aperture:
123x70 mm

Bulb type: H3
Socket type: PK22s
Inclination/downwards: 180°
Inclination/upwards: 180°
Inclination/sideways: 105°
Colour: Black
Material/dome: Glass
Material/house: Shockproof plastic
Shape: Rectangular
Mount.: Sidemounted
Tightness norm: IP 55

171619 Work Lamp



Bulb incl.: No
Watt: 70

Dim.: 160x165x90 mm
Light aperture:
77x130 mm

Bulb type: H3
Socket type: PK22s
Colour: Black
Material/dome: Glass
Material/house: Shockproof plastic
Reflector system: Single
Model: Compact 5000
Shape: Oval
Mount. bracket: 4 holes
2 poles: w/

171620 Work Lamp

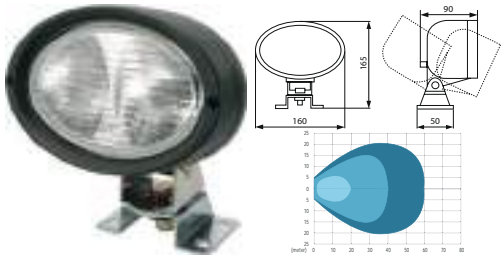

Bulb incl.: No

Dim.: 160x165x90 mm
Light aperture:
77x130 mm

Bulb type: H3
Socket type: PK22s
Colour: Black
Material/dome: Shockproof plastic
Reflector system: Dual
Model: Twin beam 5000
Shape: Oval
Mount. bracket: 4 holes
2 poles: w/

171745 Work Lamp



Bulb incl.: No

Dim.: 117x84x95 mm
Light aperture: 69 mm

Bulb type: H3
Socket type: PK22s
Colour: Black
Material/dome: Glass
Material/house: ABS plastic
Reflector system: Single
Shape: Round
Mount. bracket: U-bracket w/ 1 bolt
2 poles: w/
Tightness norm: IP 66

171782 Work Lamp

w/ Deutsch multiconnection.



Bulb incl.: No

Dim.: 100x151x91 mm
Light aperture:
73x73 mm

Bulb type: H3
Socket type: PK22s
Colour: Black
Material/dome: Glass
Material/house: Shockproof plastic
Reflector system: Single
Shape: Square
Mount.: Upright/pendant
Switch: w/
Mount. bracket: Single bolt fixing
2 poles: w/
Tightness norm: IP 66

171845 Work Lamp

Servicing: Marine

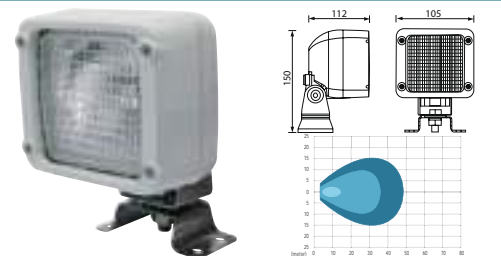

Bulb incl.: Yes
Voltage: 12
Watt: 55

Dim.: 105x150x112 mm

Bulb type: H3
Socket type: PK22s
Colour: White
Material/dome: Glass
Shape: Square
Mount.: Single bolt fixing
Mount. bracket: Mounting bracket
Tightness norm: IP 65

171848 Work Lamp

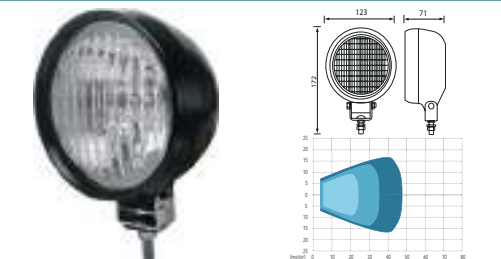

Bulb incl.: No

Dim.: 123x172x71 mm

Bulb type: H3
Socket type: PK22s
Colour: Black
Material/dome: Glass
Material/house: PVC
Shape: Round
Mount. bracket: Single bolt fixing

WORK LAMPS LED

171640 LED Work Lamp

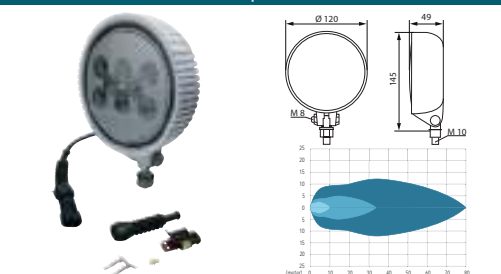

Voltage: 9-30
Watt: 24
Lumen: 1440

Dim.: 120x145x49 mm
Light aperture: 130 mm

Bulb type: LED
Colour: Grey
Material/house: Aluminium
Model: 8 LED
Shape: Round
Switch: w/o
Mount. bracket: 1 nut
2 poles: w/
Tightness norm: IP 69K
Approvals: EMC/ADR/GGVS

171671 LED Work Lamp

4 diodes. Black cable negative.

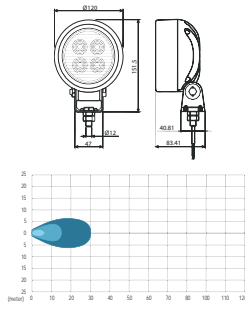

Voltage: 9-56
Watt: 8.5
Candela: 800
Kelvin: 5000-6500
Lumen: 450

Dim.: 151.5x120x83.41 mm
Light aperture: 100 mm

Bulb type: LED
Colour: Black
Material/dome: Shockproof plastic
Material/house: Shock thermo plastic
Shape: Round
Mount. bracket: 1 nut
Tightness norm: IP 66

171672 LED Work Lamp

4 diodes.

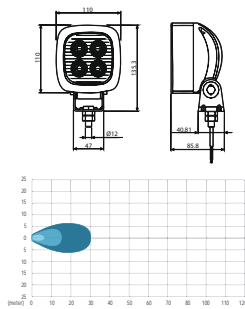

Voltage: 9-56
Watt: 8.5
Candela: 800
Kelvin: 5000-6500
Lumen: 450

Dim.: 135.5x110x85.8 mm
Light aperture: 100 mm

Bulb type: LED
Colour: Black
Material/dome: Shockproof plastic
Material/house: Shockproof plastic
Shape: Square
Mount. bracket: 1 nut
Tightness norm: IP 66

171723 LED Work Lamp

Servicing: Marine

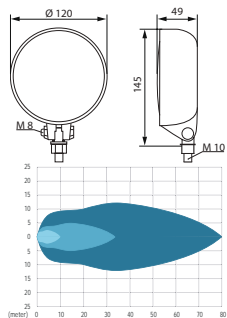

Voltage: 9-30
Watt: 24
Lumen: 1440

Dim.: 120x145x49 mm
Light aperture: 130 mm

Bulb type: LED
Colour: White
Material/house: Aluminium
Model: 8 LED - Marine
Shape: Round
Mount. bracket: 1 nut
2 poles: w/
Tightness norm: IP 69K
Approvals: EMC/ADR/GGVS

171727 LED Work Lamp

Grey lead +, white lead -.

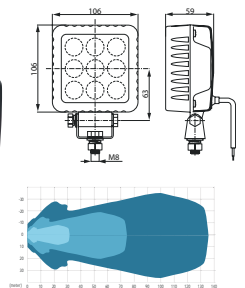

Voltage: 9-33
Watt: 9
Kelvin: 5000-5500
Lumen: 800-1000

Dim.: 106x106x59 mm
Light aperture: 85x85 mm

Bulb type: LED
Colour: Black
Material/dome: Shockproof plastic
Material/house: Cast aluminum
Model: 9 LED
Shape: Square
Mount. bracket: U-bracket w/ 1 bolt
Tightness norm: IP 67
Approvals: CE/EMC

171751 LED Work Lamp

White cable to ground. Black cable to +12/36 V.

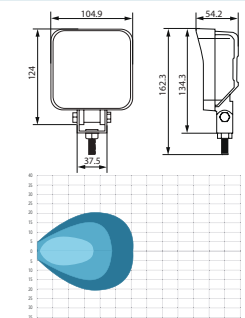

Voltage: 9-36
Watt: 19
Candela: 2210
Lumen: 1200

Dim.: 104.9x162.3x54.2 mm
Light aperture: 100x100 mm

Bulb type: LED
Colour: Black
Material/dome: Polycarbonate
Material/house: Cast aluminum
Model: 6 LED
Mount. bracket: U-bracket w/ 1 bolt
Tightness norm: IP 69K
Approvals: CE/EMC

171752 LED Work Lamp

White cable to ground. Black cable to +12/36 V.

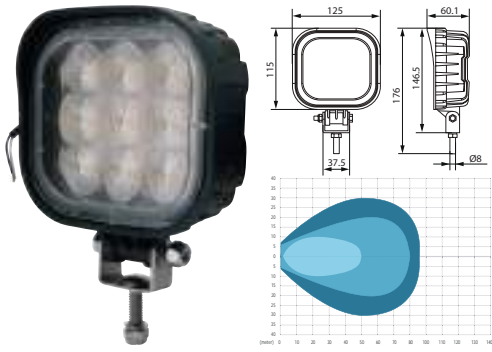

Voltage: 12-36
Watt: 20
Candela: 3600
Lumen: 1800

Dim.: 125x176x60.1 mm
Light aperture:
93x83 mm

Bulb type: LED
Colour: Black
Material/dome: Polycarbonate
Material/house: Cast aluminum
Model: 9 LED
Mount. bracket: U-bracket w/ 1 bolt
Tightness norm: IP 69K

171753 LED Work Lamp

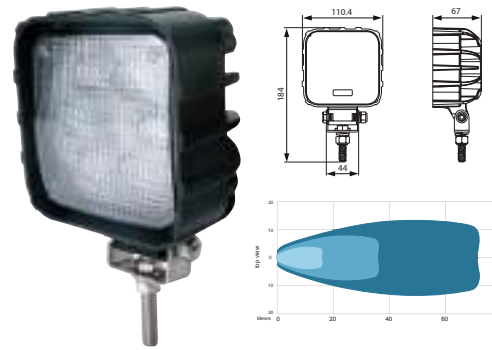

Voltage: 11-70
Watt: 22
Lumen: 1000

Dim.: 110.4x184x67 mm
Light aperture:
88x88 mm

Bulb type: LED
Colour: Black
Material/house: Cast aluminum
Model: 6 LED
Shape: Square
Mount. bracket: Single bolt fixing
Tightness norm: IP 67

171755 LED Work Lamp



Voltage: 11-70
Watt: 27
Lumen: 1900

Dim.: 110.4x184x67 mm
Light aperture:
88x88 mm

Bulb type: LED
Colour: Black
Material/house: Cast aluminum
Model: 6 LED
Mount. bracket: Single bolt fixing
Tightness norm: IP 67
E-approval: No

171774 LED Work Lamp

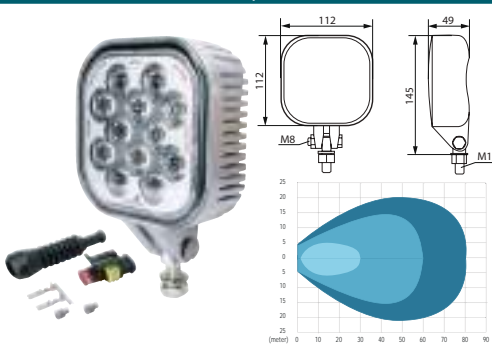

Voltage: 11-30
Watt: 40
Lumen: 3200

Dim.: 112x112x49 mm

Bulb type: LED
Colour: Silver
Material/house: Cast aluminum
Model: 12 LED
Shape: Square
Mount. bracket: U-bracket w/ 1 bolt
Tightness norm: IP 69K
Approvals: EMC/ADR/GGVS

171775 LED Work Lamp

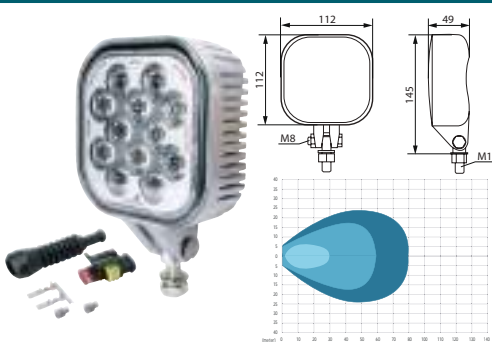

Voltage: 11-30
Watt: 36
Lumen: 1800

Dim.: 112x112x49 mm

Bulb type: LED
Colour: Silver
Material/house: Cast aluminum
Model: 12 LED
Mount. bracket: U-bracket w/ 1 bolt
Tightness norm: IP 69K
Approvals: EMC/ADR/GGVS

171811 LED Work Lamp

Pre-wired w/ 30 cm cable.

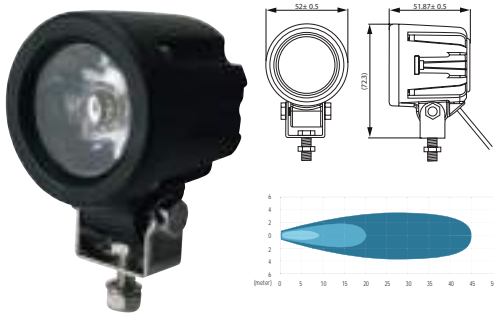

Voltage: 10-80
Watt: 5
Candela: 2000
Kelvin: 5000-6500
Lumen: 600

Dim.: 72.3x52x51.87 mm
Light aperture: 35 mm

Bulb type: LED
Inclination/downwards: Yes
Inclination/upwards: Yes
Colour: Black
Material/dome: Plastic
Material/house: Aluminium
Shape: Round
Mount. bracket: U-bracket w/ 1 bolt
Tightness norm: IP 66
Approvals: CE

171838 LED Work Lamp

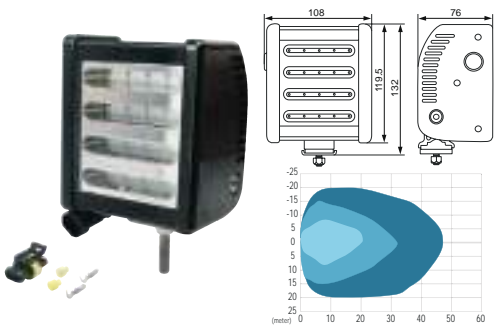

Voltage: 9-36
Amp: 1.2/2.5
Watt: 28-30
Lumen: 3000

Dim.: 132x108x76 mm

Colour: Black
Material/dome: Polycarbonate
Material/house: Aluminium
Model: 20 LED
Shape: Square
Mount. bracket: Single bolt fixing
2 poles: w/
Tightness norm: IP 67
Approvals: CE

171846 LED Work Lamp

2 pin AMP connector.

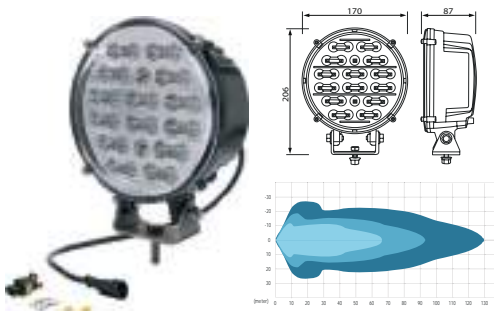

Voltage: 9-36
Amp: 6/3
Watt: 67.5
Lumen: 5400

Dim.: 170x206x87 mm

Bulb type: LED
Inclination/downwards: 45°
Inclination/upwards: 45°
Colour: Black
Material/dome: Polycarbonate
Material/house: Aluminium
Shape: Round
Mount. bracket: U-bracket w/ 1 bolt
2 poles: w/
Tightness norm: IP 67
Approvals: CE

171847 LED Work Lamp

Pre-wired w/ 30 cm cable.

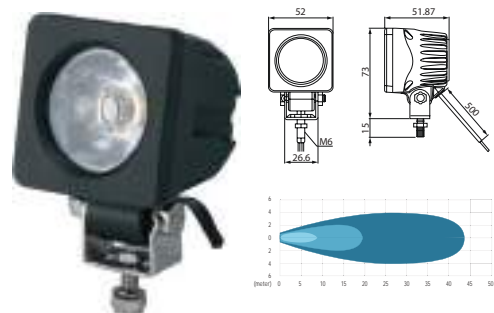

Voltage: 10-80
Amp: 0.3
Watt: 5
Candela: 2000
Kelvin: 5000-6500
Lumen: 600

Dim.: 52x51.9x72.3 mm

Bulb type: LED
Inclination/downwards: Yes
Inclination/upwards: Yes
Colour: Black
Model: LED
Shape: Square
Tightness norm: IP 67
Approvals: CE

171938 LED Work Lamp

Flood type.

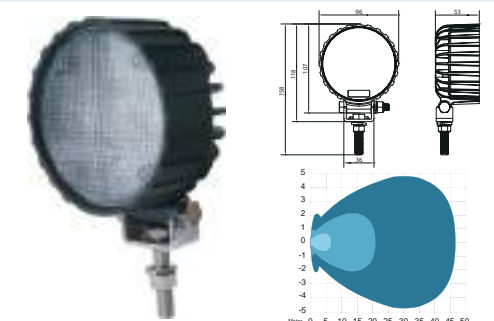

Voltage: 9-50
Amp: <0.55
Watt: 10.8
Lumen: 900

Dim.: 96x118x53 mm
Cable length: 380 mm
Light aperture: 90 mm

Bulb type: 4 LED
Colour: Black
Material/dome: Polycarbonate
Material/house: Aluminium
Shape: Round
Mount. bracket: 1 bolt
Tightness norm: IP 68
Approvals: CE/EMC

171939 LED Work Lamp

Spot.

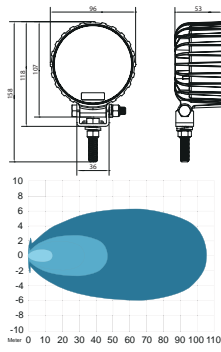

Voltage: 9-50
Amp: <0.65
Watt: 11
Lumen: 900

Dim.: 96x118 mm
Cable length: 380 mm
Light aperture: 90 mm

Bulb type: 4 LED
Colour: Black
Material/dome: Polycarbonate
Material/house: Aluminium
Shape: Round
Mount. bracket: 1 bolt
Tightness norm: IP 68
Approvals: CE/EMC

171940 LED Work Lamp

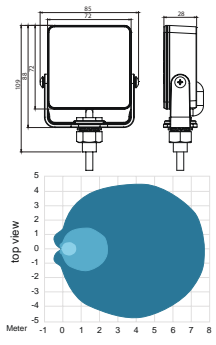

Voltage: 12-24
Amp: 0.37
Watt: 7.5

Dim.: 88x85 mm
Cable length: 380 mm
Light aperture: 72 mm

Bulb type: 4 LED
Material/dome: Polycarbonate
Material/house: Aluminium
Shape: Square
Mount. bracket: U-bracket w/ 1 bolt
Tightness norm: IP 67
Approvals: CE

171944 LED Work Lamp

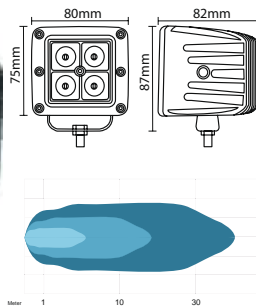

Voltage: 10-30
Watt: 16
Kelvin: 6000
Lumen: 800

Dim.: 87x80x75 mm

Bulb type: 4 LED
Colour: Black
Material/ bracket: Stainless steel
Material/dome: Polycarbonate
Material/house: Cast aluminum
Shape: Square
Mount.: Cable
Tightness norm: IP 67
Approvals: CE

171945 LED Work Lamp

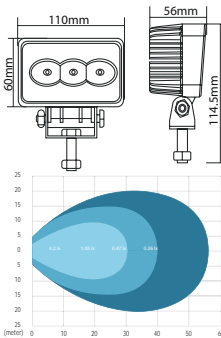

Voltage: 10-30
Watt: 9
Kelvin: 6000
Lumen: 600

Dim.: 60x110x56 mm

Bulb type: 3 LED
Colour: Black
Material/ bracket: Stainless steel
Material/dome: Polycarbonate
Material/house: Cast aluminum
Shape: Rectangular
Mount.: Cable
Tightness norm: IP 67
Approvals: CE



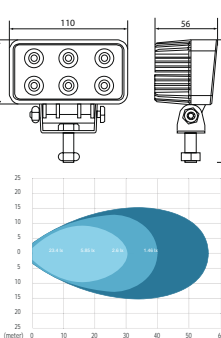

171946 LED Work Lamp

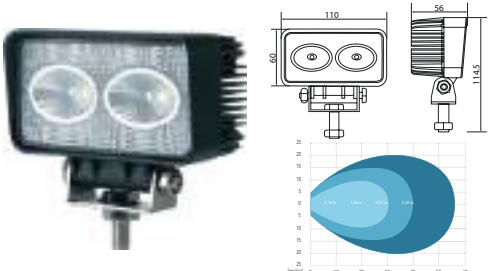
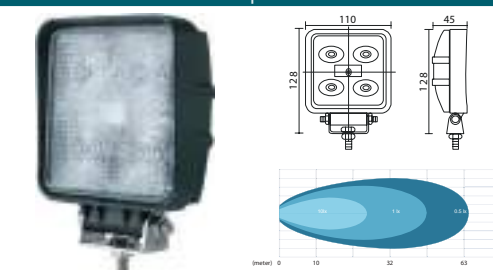

Voltage: 10-30
Watt: 18
Kelvin: 6000
Lumen: 1200

Dim.: 60x110x56 mm

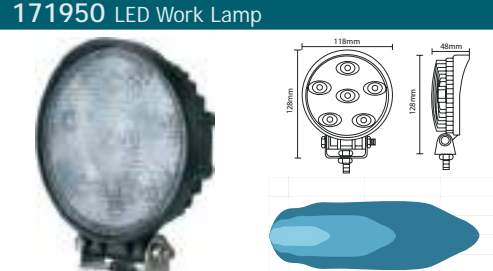
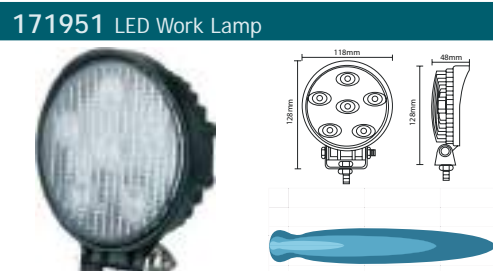
Bulb type: 6 LED
Colour: Black
Material/ bracket: Stainless steel
Material/dome: Polycarbonate
Material/house: Cast aluminum
Shape: Rectangular
Mount.: Cable
Tightness norm: IP 67
Approvals: CE

	EL. SPECIFICATIONS	DIMENSIONS	ADDITIONAL SPECIFICATIONS
171947 LED Work Lamp	 <p>Voltage: 10-30 Watt: 20 Kelvin: 6000 Lumen: 1600</p>	Dim.: 60x110x56 mm	Bulb type: 2 LED Colour: Black Material/ bracket: Stainless steel Material/dome: Polycarbonate Material/house: Cast aluminum Shape: Rectangular Mount.: Cable Tightness norm: IP 67 Approvals: CE
171948 LED Work Lamp	 <p>Voltage: 10-30 Watt: 15 Kelvin: 6000 Lumen: 1100</p>	Dim.: 128x110x45 mm	Bulb type: 5 LED Colour: Black Material/ bracket: Stainless steel Material/dome: Polycarbonate Material/house: Cast aluminum Shape: Square Mount.: Cable Tightness norm: IP 67 Approvals: CE
171949 LED Work Lamp	 <p>Voltage: 10-30 Watt: 15 Kelvin: 6000 Lumen: 1100</p>	Dim.: 128x110x45 mm	Bulb type: 5 LED Colour: Black Material/ bracket: Stainless steel Material/dome: Polycarbonate Material/house: Cast aluminum Shape: Square Mount.: Cable Tightness norm: IP 67 Approvals: CE
171950 LED Work Lamp	 <p>Voltage: 10-30 Watt: 18 Kelvin: 6000 Lumen: 1200</p>	Dim.: 128x116x48 mm	Bulb type: 6 LED Colour: Black Material/ bracket: Stainless steel Material/dome: Polycarbonate Material/house: Cast aluminum Shape: Round Mount.: Cable Tightness norm: IP 67 Approvals: CE
171951 LED Work Lamp	 <p>Voltage: 10-30 Watt: 18 Kelvin: 6000 Lumen: 1200</p>	Dim.: 128x116x48 mm	Bulb type: 6 LED Colour: Black Material/ bracket: Stainless steel Material/dome: Polycarbonate Material/house: Cast aluminum Shape: Round Mount.: Cable Tightness norm: IP 67 Approvals: CE
171955 LED Work Lamp	 <p>Voltage: 12-24 Watt: 24 Kelvin: 5000-7000 Lumen: 1500</p>	Dim.: 100x100x76 mm	Bulb type: 6 LED Inclination/downwards: 80° Inclination/upwards: 90° Inclination/sideways: 180° Colour: Black Material/dome: Plastic Material/house: ABS plastic/aluminium 2 poles: w/ Tightness norm: IP 68 Approvals: CE

Accessories: HC-CARGO 190252, 190261, 191029, 193010.

172001 LED Work Lamp

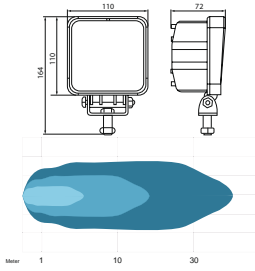

Voltage: 10-80
Watt: 48
Kelvin: 6000
Lumen: 3500

Dim.: 164x110x72 mm

Bulb type: 16 LED
Colour: Black
Material/ bracket: Stainless steel
Material/dome: Polycarbonate
Material/house: Cast aluminum
Shape: Square
Mount.: Cable
2 poles: w/
Tightness norm: IP 67
Approvals: CE/EMC

172003 LED Work Lamp

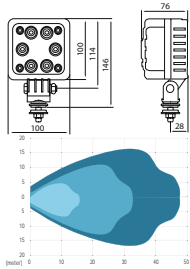

Voltage: 12-24
Watt: 24
Kelvin: 5000-7000
Lumen: 1500

Dim.: 100x100x76 mm
Cable length: 500 mm

Bulb type: 6 LED
Inclination/downwards: 80°
Inclination/upwards: 90°
Inclination/sideways: 180°
Colour: Black
Material/dome: Plastic
Material/house: ABS plastic/aluminium
Switch: w/
Tightness norm: IP 68
Approvals: CE

172004 LED Work Lamp

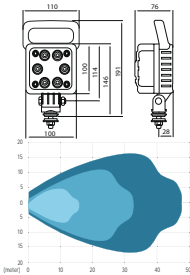

Voltage: 12-24
Watt: 24
Kelvin: 5000-7000
Lumen: 1500

Dim.: 205x110x76 mm
Cable length: 500 mm

Bulb type: 6 LED
Inclination/downwards: 80°
Inclination/upwards: 90°
Inclination/sideways: 180°
Colour: Black
Material/dome: Plastic
Material/house: ABS plastic/aluminium
Switch: w/
Handle: w/
Tightness norm: IP 68
Approvals: CE

172010 LED Work Lamp

280 mm cable.

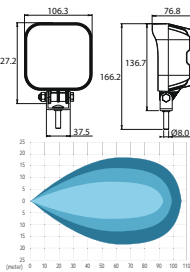

Voltage: 12-36
Watt: 40
Lumen: 3200

Dim.: 127.2x106.3x76.8 mm

Bulb type: LED
Colour: Black
Material/house: Aluminium
Model: 4 LED
Shape: Square
Mount. bracket: U-bracket w/ 1 bolt
Tightness norm: IP 69K
Approvals: CE/EMC

172017 LED Work Lamp

NEW PRODUCT
www.hc-cargo.com

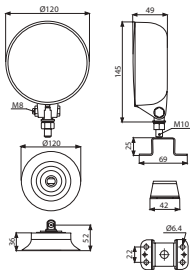
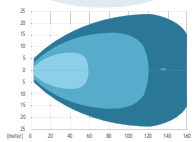

Voltage: 12-24
Watt: 34
Lumen: 2600

Dim.: 145x120x49 mm

Bulb type: 12 LED
Material/house: Aluminium
Model: 12 LED
Magnet base: w/
Tightness norm: IP 69K
Approvals: EMC/ADR/GGVS

172018 LED Work Lamp

NEW PRODUCT
www.hc-cargo.com

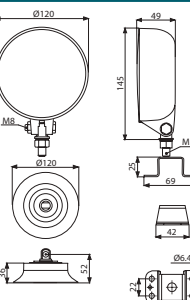
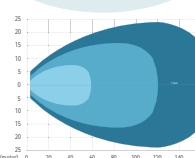

Voltage: 12-24
Watt: 34
Lumen: 2600

Dim.: 145x120x49 mm

Material/house: Aluminium
Model: 12 LED
Tightness norm: IP 69K
Approvals: EMC/ADR/GGVS

172019 LED Work Lamp

NEW PRODUCT
www.hc-cargo.com

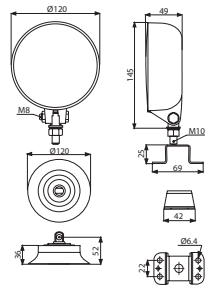
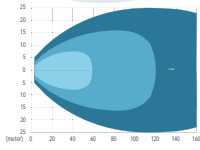

Voltage: 12-24
Watt: 40
Lumen: 4000

Dim.: 145x120x49 mm

Material/house: Aluminium
Model: 12 LED
Tightness norm: IP 69K
Approvals: EMC/ADR/GGVS

172020 LED Work Lamp

NEW PRODUCT
www.hc-cargo.com

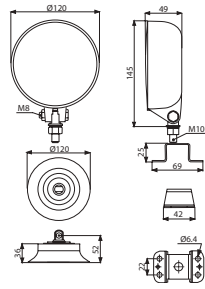
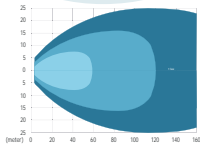

Voltage: 12-24
Watt: 40
Lumen: 4000

Dim.: 145x120x49 mm

Material/house: Aluminium
Model: 12 LED
Magnet base: w/
Tightness norm: IP 69K
Approvals: EMC/ADR/GGVS

172031 LED Work Lamp

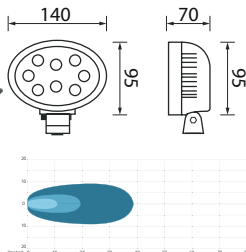

Voltage: 10-80
Watt: 24
Kelvin: 6000
Lumen: 1920

Dim.: 140x95x70 mm
Cable length: 400 mm

Bulb type: 8 LED
Material/dome: Acrylic
Material/house: Cast aluminum
Shape: Oval
2 poles: w/
Tightness norm: IP 69K
Approvals: CE

172032 LED Work Lamp

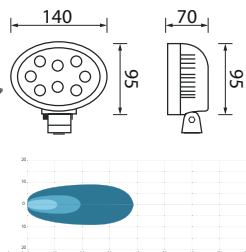

Voltage: 10-80
Watt: 36
Kelvin: 6000
Lumen: 2880

Dim.: 140x95x70 mm
Cable length: 400 mm

Bulb type: 12 LED
Material/dome: Acrylic
Material/house: Cast aluminum
Shape: Oval
2 poles: w/
Tightness norm: IP 69K
Approvals: CE

172045 LED Work Lamp

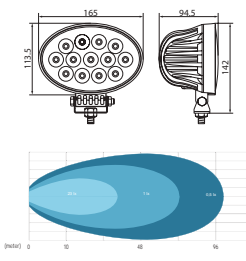

Voltage: 10-80
Watt: 65
Kelvin: 6000
Lumen: 5850

Dim.: 165x142x94.5 mm

Bulb type: 13 LED
Colour: Black
Material/ bracket: Stainless steel
Material/dome: Polycarbonate
Material/house: Aluminium
Shape: Oval
2 poles: w/
Tightness norm: IP 69K
Approvals: CE

172046 LED Work Lamp

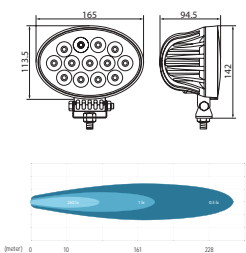

Voltage: 10-80
Watt: 65
Kelvin: 6000
Lumen: 5850

Dim.: 165x142x94.5 mm

Bulb type: 13 LED
Colour: Black
Material/ bracket: Stainless steel
Material/dome: Polycarbonate
Material/house: Aluminium
Shape: Oval
2 poles: w/
Tightness norm: IP 69K
Approvals: CE

172055 LED Work Lamp

NEW PRODUCT
www.hc-cargo.com

Voltage: 10-80
Amp: 0.83/0.42
Watt: 10
Kelvin: 6000
Lumen: 900

Cable length: 500 mm

Bulb type: LED
Material/ bracket: Stainless steel
Material/dome: Polycarbonate
Material/house: Cast aluminum
Mount. bracket: U-bracket w/ 1 bolt
2 poles: w/
Tightness norm: IP 69K
Approvals: CE

172056 LED Work Lamp

NEW PRODUCT
www.hc-cargo.com

Voltage: 10-80
Amp: 0.83/0.42
Watt: 10
Kelvin: 6000
Lumen: 900

Cable length: 500 mm

Bulb type: LED
Material/ bracket: Stainless steel
Material/dome: Polycarbonate
Material/house: Cast aluminum
Mount. bracket: U-bracket w/ 1 bolt
2 poles: w/
Tightness norm: IP 69K
Approvals: CE

ACCESSORIES

172005 Bracket

Servicing: HC-CARGO 171955, 172003, 172004



Dim.: 59x37 mm
Mount. hole size:
24 mm

Material: Plastic
Standard ISO A - Rod

172008 Handle for LED Work Lamp

Servicing: HC-CARGO: 171948, 171949, 171950, 171951, 172001



Colour: Black
Material/ bracket: Aluminium
Mount. bracket: 2 screws

WORK LAMPS HID

171594 HID Work Lamp

Bulb: HC-CARGO 171595.

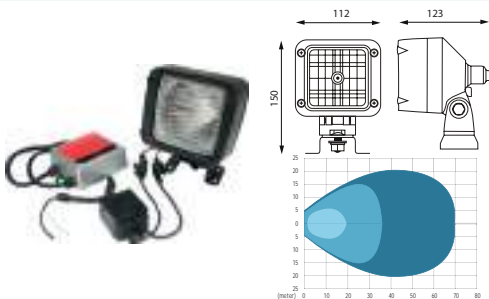

Bulb incl.: Yes
Voltage: 12

Dim.: 112x150x123 mm
Light aperture:
73x73 mm

Bulb type: H3
Colour: Black
Material/dome: Glass
Material/house: Shockproof plastic
Shape: Square
Switch: w/o
Ballast: External
Mount. bracket: Mounting bracket
Magnet base: w/o
Handle: w/o
2 poles: w/
Tightness norm: IP 65

171611 HID Work Lamp

Bulb: HC-CARGO 171595.

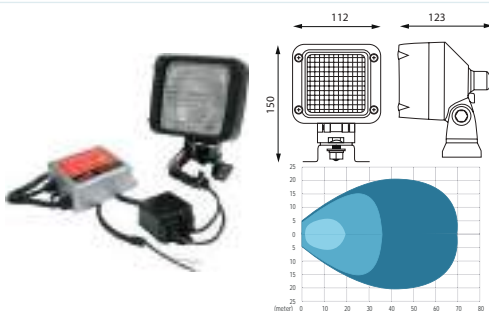

Bulb incl.: Yes
Voltage: 24

Dim.: 112x150x123 mm
Light aperture:
73x73 mm

Bulb type: H3
Colour: Black
Material/dome: Glass
Material/house: Shockproof plastic
Model: HID
Shape: Square
Switch: w/o
Ballast: External
Mount. bracket: Mounting bracket
Magnet base: w/o
Handle: w/o
2 poles: w/
Tightness norm: IP 65

171615 HID Work Lamp

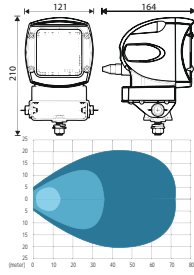

Bulb incl.: Yes
Voltage: 12
Watt: 35

Dim.: 210x164x121 mm
Light aperture:
73x73 mm

Bulb type: D1S
Socket type: PK32d-2
Colour: Black
Material/dome: Glass
Material/house: Shockproof plastic
Reflector system: Single
Shape: Square
Switch: w/o
Mount. bracket: Mounting bracket
Magnet base: w/o
Handle: w/o
Tightness norm: IP 65

171625 HID Work Lamp

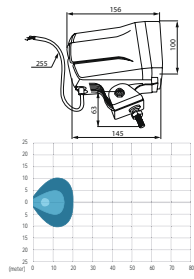

Bulb incl.: Yes
Voltage: 12
Watt: 35

Dim.: 156x100 mm
Light aperture: 75 mm

Bulb type: D2S
Socket type: PK32d-2
Colour: Black
Material/dome: Glass
Material/house: Aluminium
Reflector system: Single
Shape: Square
Switch: w/o
Mount. bracket: U-bracket w/ 1 bolt
Magnet base: w/o
Handle: w/o
2 poles: w/o

171626 HID Work Lamp

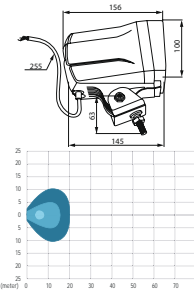

Bulb incl.: Yes
Voltage: 24
Watt: 35

Dim.: 156x100 mm
Light aperture: 75 mm

Bulb type: D2S
Socket type: PK32d-3
Colour: Black
Material/dome: Glass
Material/house: Aluminium
Reflector system: Single
Shape: Square
Mount.: Single bolt fixing
Switch: w/o
Mount. bracket: Mounting bracket
Magnet base: w/o
Handle: w/o
2 poles: w/o

SPARE PARTS

171595 Xenon Bulb

Servicing: HC-CARGO 171594



Bulb type: Xenon, H3

171612 Ballast

Servicing: HC-CARGO 171611

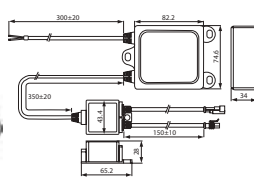

Voltage: 24

Model: HID

SPOT LIGHTS

170293 Spot Light

Hand-held.

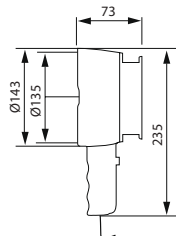

Bulb incl.: Yes
Voltage: 12
Watt: 55

Dim.: 235x73 mm
Cable length: 6000 mm
Connection cable: w/
Light aperture: 120 mm

Type: Halogen
Bulb type: H3
Socket type: PK22s
Colour: Black
Material/house: Shockproof plastic
Shape: Round
Switch: w/
Protective cover: w/
Lighter plug incl.: Yes
Connection cable: w/

170564 Spot Light

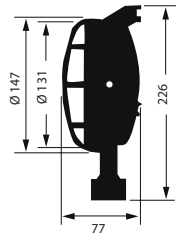

Bulb incl.: No

Dim.: 226x77 mm
Light aperture: 131 mm

Bulb type: H3
Socket type: PK22s
Inclination/sideways: Yes
Colour: Black
Material/dome: Glass
Material/house: Shockproof plastic
Switch: w/
Grill: w/
Handle: w/

171375 Spot Light

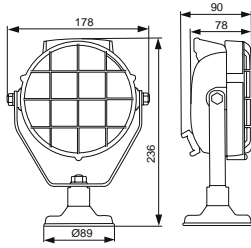

Bulb incl.: No

Dim.: 178x236x90 mm
Coiled cable: 2000 mm
Light aperture: 130 mm

Bulb type: H3
Socket type: PK22s
Colour: Black
Material/dome: Glass
Material/house: Metal
Shape: Round
Switch: w/
Mount. bracket: Mounting bracket
Grill: w/
Magnet base: w/
Lighter plug incl.: Yes
Handle: w/
Coiled cable incl.: Yes

171464 Spot Light

Remote controlled by EU approved radio controller. Frequency 433.92 MHZ. Reach up to 100 m. Incl. 9 V battery. Battery: HC-CARGO 200742, 200769.

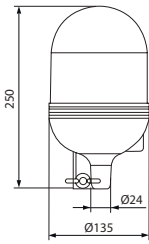

Bulb incl.: Yes
Voltage: 12
Watt: 55

OD: 135 mm
Height: 250 mm
Width: 135 mm

Bulb type: H1
Lens type: Polycarbonate
Mount.: Standard ISO A - Rod
Base: Rigid
Hi impact: Yes
Tightness norm: IP 55
Approval: CE

171466 Spot Light

Remote controlled by EU approved radio controller. Frequency 433.92 MHZ. Reach up to 100 m. Incl. 9 V battery. Battery: HC-CARGO 200742, 200769.

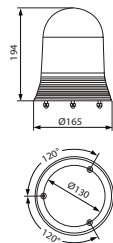

Bulb incl.: Yes
Voltage: 12
Watt: 55

OD: 160 mm
Height: 194 mm
Width: 165 mm

Bulb type: H1
Lens type: Polycarbonate
Mount.: Standard ISO B2 (and B1) - Base
Hi impact: Yes
Tightness norm: IP 55

ACCESSORIES

170653 Beacon Socket

Servicing: HC-CARGO 170650, 170651, 171466

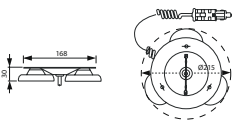

Cable length: 2000 mm
Height: 30 mm
Width: 168 mm

Mount.: 3 magnets
Base: Magnetic
Coiled cable incl.: Yes
Tightness norm: IP 55
E-approval: Yes

171936 Magnetic base for Lamps

Servicing: HC-CARGO 170534



Coiled cable: 2000 mm

Colour: Black
Mount.: Magnetic
Mount. bracket: U-bracket w/ 2 holes
Magnet base: w/
Lighter plug incl.: Yes
Coiled cable incl.: Yes

FORWARD LIGHTING

TRACTOR HEAD LAMPS

170132 Head Lamp

Light unit: HC-CARGO 170239.

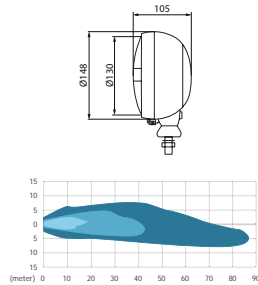

Bulb incl.: No
Watt: 45/40
Watt 2: 55/50
Watt 3: 4

Dim.: 148x105 mm
Light aperture: 130 mm

Socket type 1: P45t
Socket type 2: P45t
Socket type 3: BA9s
Colour: Black
Material: Metal
Material/dome: Glass
Shape: Round
Mount.: 1 bolt
Sidemarker: w/
Grill: w/o
Asymmetric light: w/
RH/LH: LH
E-approval: Yes

170310 Head Lamp

For upright fixing.

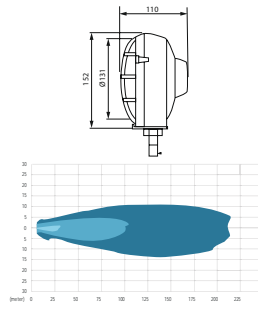

Bulb incl.: No
Watt: 45/40
Watt 2: 55/50
Watt 3: 4

Dim.: 152x110 mm
Light aperture: 131 mm

Bulb type 1: H4
Bulb type 2: H4
Socket type 1: P45t
Socket type 2: P45t
Socket type 3: BA9s
Colour: Black
Material: Plastic
Material/dome: Glass
Shape: Round
Mount.: 1 bolt
Sidemarker: w/
Grill: w/
Asymmetric light: w/
RH/LH: LH
E-approval: Yes

170311 Head Lamp

Horizontal fixing.

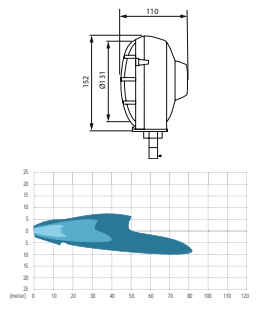

Bulb incl.: No
Watt 1: 45/40
Watt 2: 55/50
Watt 3: 4

Dim.: 152x110 mm
Light aperture: 131 mm

Bulb type 1: H4
Bulb type 2: H4
Socket type 1: P45t
Socket type 2: P45t
Socket type 3: BA9s
Colour: Black
Material: Plastic
Material/dome: Glass
Shape: Round
Mount.: 1 bolt
Sidemarker: w/
Grill: w/
Asymmetric light: w/
RH/LH: LH
E-approval: Yes

170843 Head Lamp

Light unit: HC-CARGO 170844.

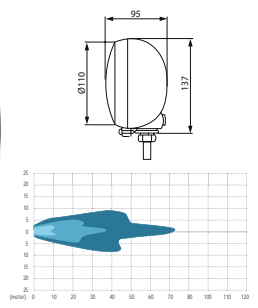

Bulb incl.: No
Watt 1: 45/40
Watt 2: 55/50
Watt 3: 4

Dim.: 137x95 mm
Light aperture: 110 mm

Socket type 1: BA20d
Socket type 2: BA20d
Socket type 3: BA9s
Colour: Black
Material: Metal
Material/dome: Glass
Shape: Round
Mount.: 1 bolt
Sidemarker: w/
Grill: w/o
Asymmetric light: w/o
RH/LH: RH/LH
E-approval: Yes

170865 Head Lamp

Servicing: Zetor: Model 2002, Proxima, Forterra, Super, Super Eko, Classic Eko

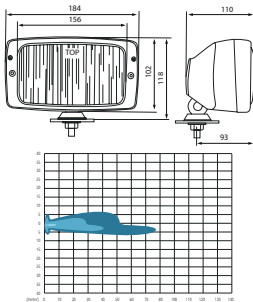

Bulb incl.: No
Watt 1: 60/55
Watt 2: 75/70

Dim.: 184x118x110 mm
Light aperture: 156 mm

Bulb type 1: H4
Bulb type 2: H4
Socket type 1: P43t
Socket type 2: P43t
Colour: Black
Material: Shockproof plastic
Material/dome: Glass
Shape: Rectangular
Mount.: Horizontal
Asymmetric light: w/
RH/LH: LH
E-approval: Yes

170974 Head Lamp

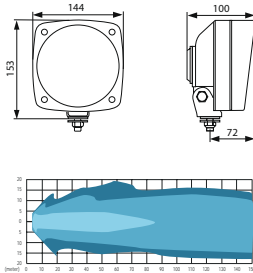

Bulb incl.: No
Watt 1: 60/55
Watt 2: 75/70

Dim.: 144x153x100 mm
Light aperture: 110 mm

Bulb type 1: H4
Bulb type 2: H4
Socket type 1: P43t
Socket type 2: P43t
Colour: Black
Material: Shockproof plastic
Material/dome: Glass
Shape: Rectangular
Mount.: Horizontal/vertical
Asymmetric light: w/
RH/LH: LH
E-approval: Yes

171006 Head Lamp

Light unit: HC-CARGO 171007.

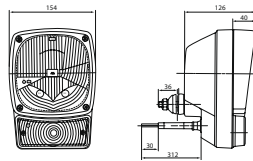

Bulb incl.: Yes
12 V
Watt 1: 60/55
Watt 2: 75/70

Dim.: 208x154x126 mm
Light aperture: 142 mm

Bulb type 1: H4
Bulb type 2: H4
Socket type 1: P43t
Socket type 2: P43t
Colour: Black
Material: Shockproof plastic
Material/dome: Glass
Shape: Rectangular
Mount.: Horizontal/vertical
Flasher light: w/
Sidemarker: w/
Asymmetric light: w/
RH/LH: RH/LH
E-approval: Yes

171038 Head Lamp

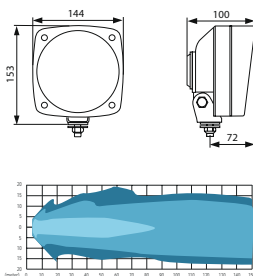

Bulb incl. 1: No
Watt: 60/65
Watt 2: 75/70
Watt 3: 4

Dim.: 144x153x100 mm
Light aperture: 110 mm

Bulb type 1: H4
Bulb type 2: H4
Socket type 1: P43t
Socket type 2: P43t
Socket type 3: BA9s
Colour: Black
Material: Shockproof plastic
Material/dome: Glass
Shape: Rectangular
Mount.: Horizontal/vertical
Sidemarker: w/
Asymmetric light: w/
RH/LH: LH
E-approval: Yes

171565 Head Lamp

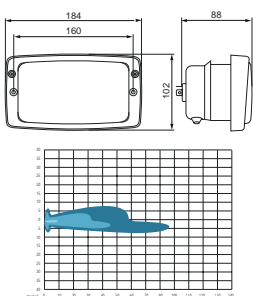

Bulb incl. 1: No
Watt: 60/55
Watt 2: 75/70
Watt 3: 4

Dim.: 184x102x88 mm
Light aperture: 160 mm

Bulb type 1: H4
Bulb type 2: H4
Socket type 1: P43t
Socket type 2: P43t
Socket type 3: BA9s
Colour: Black
Material: Shockproof plastic
Material/dome: Glass
Shape: Square
Mount.: Horizontal/vertical
Sidemarker: w/
Asymmetric light: w/
RH/LH: RH/LH
E-approval: Yes

SPARE PARTS			
170239 Light Unit			
Servicing: HC-CARGO 170132			
	Bulb incl.: No Watt 1: 45/40 Watt 2: 55/50 Watt 3: 4	Dim.: 139x67 mm Light aperture: 130 mm	Socket type 1: P45t Socket type 2: P45t Socket type 3: BA9s Material: Glass Shape: Round Sidemarker: w/ Asymmetric light: w/ RH/LH: LH E-approval: Yes
170844 Light Unit			
Servicing: HC-CARGO 170843			
	Bulb incl.: No Watt 1: 45/40 Watt 2: 55/50 Watt 3: 4	Dim.: 117.5x57 mm Light aperture: 110 mm	Socket type 1: BA20d Socket type 2: BA20d Socket type 3: BA9s Shape: Round Asymmetric light: w/
171007 Light Unit			
Servicing: HC-CARGO 171006, 170926			
	Bulb incl.: No Watt 1: 60/55 Watt 2: 75/70	Dim.: 142x142x82 mm Light aperture: 142 mm	Bulb type 1: H4 Bulb type 2: H4 Socket type 1: P43t Socket type 2: P43t Material: Glass Shape: Square Asymmetric light: w/ E-approval: Yes
171008 Lens			
Servicing: HC-CARGO 171006, 170926			
			Colour: Orange
171937 Bulb Gasket			
Servicing: HC-CARGO 170865			
		OD: 83 mm	Material: Rubber
HEADLIGHT INSERTS			
170690 Light Unit			
Servicing: Chrysler, Fendt, Ford, GM, IH/Case, Isuzu, John Deere, Mazda			
	Bulb incl.: No Watt 1: 60/55 Watt 2: 75/70	Dim.: 167x106.7 mm Dist. mount. holes: 130x110 mm	Bulb type: H4 Bulb type 2: H4 Socket type: P43t Socket type 2: P43t Material: Metal Material/dome: Glass Shape: Rectangular Fixing screw: 3 Asymmetric light: w/ RH/LH: LH E-approval: Yes

170867 Head Lamp

Heat resistant plastic reflector bonded w/ glass lens. Flush fitting head lA. Build-in depth: 69 mm.

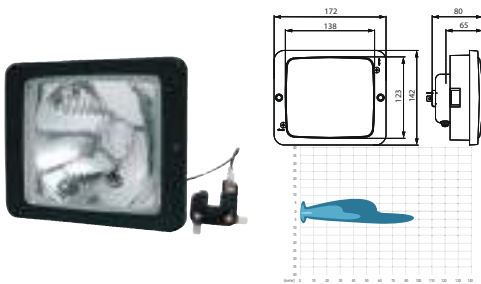

Bulb incl.: No
Watt 1: 60/55
Watt 2: 75/70
Watt 3: 4

Dim.: 172x142x80 mm

Bulb type 1: H4
Bulb type 2: H4
Socket type 1: P43t
Socket type 2: P43t
Socket type 3: BA9s
Material: Metal
Material/dome: Glass
Fixing screw: 2
Sidemarker: w/
E-approval: Yes

SEALED BEAMS
4440X Sealed Beam

Servicing: Ford

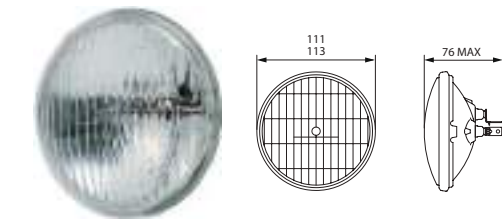

Bulb incl.: Yes
12 V
Voltage: 12
Watt: 40/40

Dim.: 113x76 mm

E-approval: No

H4360 Sealed Beam

Servicing: John Deere lawn equipment w/ cooling engine

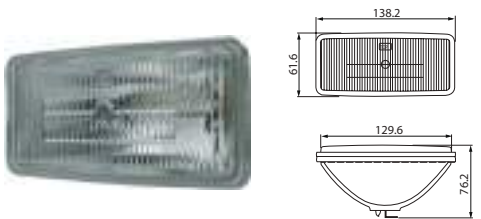

Bulb incl.: Yes
12 V
Voltage: 12
Watt: 37.5

Dim.: 138.2x61.6x76.2 mm

E-approval: No

H5360 Sealed Beam

Servicing: John Deere

Longlife.

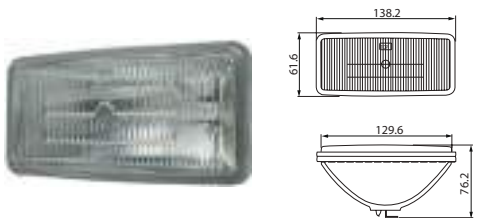

Bulb incl.: Yes
12 V
Voltage: 12
Watt: 37.5

Dim.: 138.2x61.6x76.2 mm

E-approval: No

FOG LAMPS
170616 Fog Lamp

Light unit: HC-CARGO 170622.

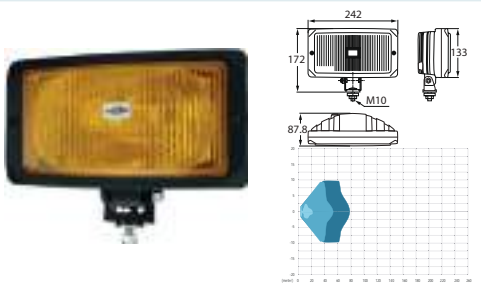

Bulb incl.: No
Watt 1: 55
Watt 2: 70

Dim.: 242x172x87.8 mm
Light aperture:
240x170 mm

Type: Fog light
Bulb type 1: H3
Bulb type 2: H3
Socket type 1: PK22s
Socket type 2: PKY22s
Colour: Yellow
Material: Metal
Material/dome: Glass
Shape: Rectangular
Mount.: Upright/pendant
E-approval: Yes

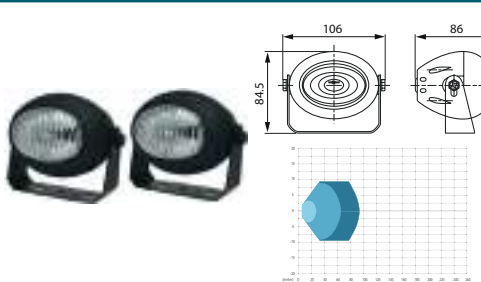
171360 Fog Lamp

Bulb incl.: No
Watt 1: 55
Watt 2: 70

Dim.: 106x84.5x86 mm
Light aperture:
55x35 mm

Type: Fog light
Bulb type 1: H3
Bulb type 2: H3
Socket type 1: PK22s
Socket type 2: PK22s
Material: Shockproof plastic
Material/dome: Glass
Shape: Oval
Mount.: U-bracket w/ 2 holes
E-approval: Yes

171362 Fog Lamp

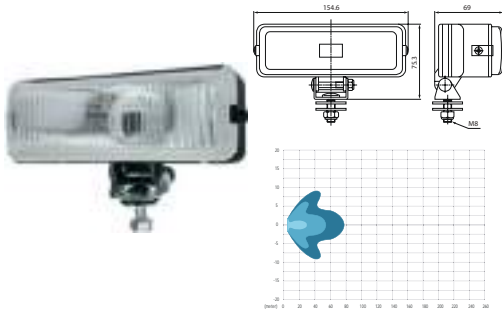

Bulb incl.: No
Watt 1: 55
Watt 2: 70

Dim.: 154.6x75.3x69 mm
Light aperture: 130x35 mm

Type: Fog light
Bulb type 1: H3
Bulb type 2: H3
Socket type 1: PK22s
Socket type 2: PK22s
Material: Shockproof plastic
Material/dome: Glass
Shape: Rectangular
Mount.: U-bracket w/ 1 bolt
E-approval: No

171364 Fog Lamp

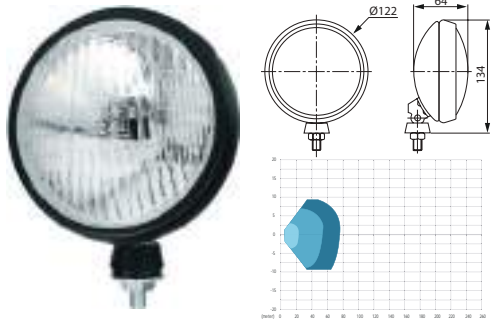

Bulb incl.: No
Voltage: 12/24
Watt 1: 55/70
Watt 2: 55
Watt 3: 70

Dim.: 122x134x64 mm
Light aperture: 95 mm

Type: Fog light
Bulb type 1: H3
Bulb type 2: H3
Socket type 1: PK22s
Socket type 2: PK22s
Colour: Black
Material: Metal
Material/dome: Glass
Shape: Round
Mount.: Mounted below
E-approval: No

171366 Fog Lamp

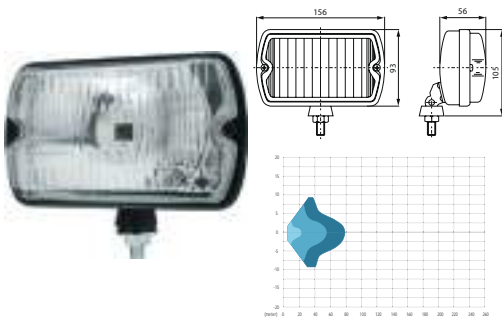

Bulb incl.: No
Watt: 55
Watt 2: 70

Dim.: 156x105x56 mm
Light aperture: 110x75 mm

Type: Fog light
Bulb type: H3
Bulb type 2: H3
Socket type: PK22s
Socket type 2: PK22s
Colour: Black
Material: Metal
Material/dome: Glass
Shape: Rectangular
Mount.: Mounted below
E-approval: Yes

171452 Fog Lamp Set

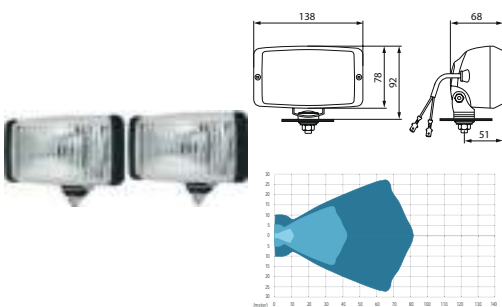

Bulb incl.: Yes
Voltage: 12
Watt: 55

Dim.: 138x78x68 mm
Light aperture: 110x60 mm

Type: Fog light
Bulb type: H3
Socket type: PK22s
Material: Shockproof plastic
Material/dome: Glass
Shape: Rectangular
Mount.: Screw
Bracket: Pendant
E-approval: Yes

DRIVING LAMP

170550 Driving Lamp

Light unit: HC-CARGO 170621.

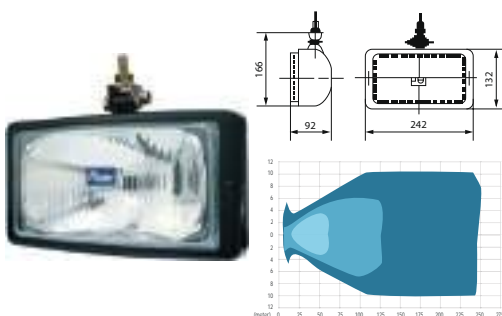

Bulb incl.: No
Watt 1: 55/70
Watt 2: 55
Watt 3: 70

Dim.: 242x166x92 mm
Light aperture: 200x107 mm

Type: Driving lamp
Bulb type 1: H3
Bulb type 2: H3
Socket type 1: PK22s
Socket type 2: PK22s
Colour: Black
Material: Metal
Material/dome: Glass
Shape: Rectangular
Mount.: Mounted below
E-approval: Yes

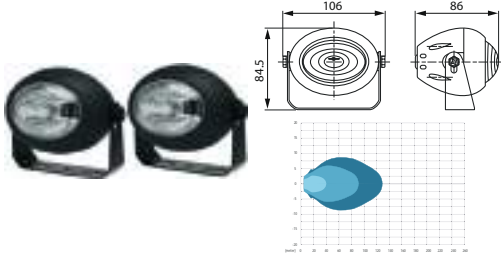
EL. SPECIFICATIONS
DIMENSIONS
ADDITIONAL SPECIFICATIONS
171359 Driving Lamp

Bulb incl.: No
Watt 1: 55
Watt 2: 70

Dim.: 106x84.5x86 mm
Light aperture:
55x35 mm

Type: Driving lamp
Bulb type 1: H3
Bulb type 2: H3
Socket type 1: PK22s
Socket type 2: PK22s
Material: Shockproof plastic
Material/dome: Glass
Shape: Oval
Mount.: U-bracket w/ 2 holes
Asymmetric light: w/o
E-approval: No

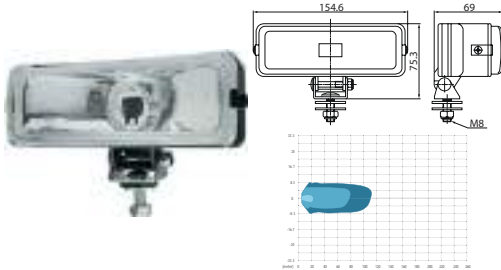
171361 Driving Lamp

Bulb incl.: No
Watt 1: 55
Watt 2: 70

Dim.: 154.6x75.3x69 mm
Light aperture:
130x35 mm

Type: Driving lamp
Bulb type 1: H3
Bulb type 2: H3
Socket type 1: PK22s
Socket type 2: PK22s
Material: Shockproof plastic
Material/dome: Glass
Shape: Rectangular
Mount.: U-bracket w/ 1 bolt
E-approval: No

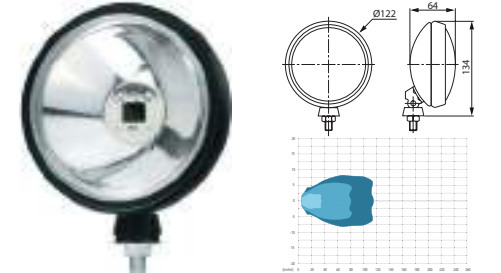
171363 Driving Lamp

Bulb incl.: No
Voltage: 12/24
Watt 1: 55
Watt 2: 70

Dim.: 122x134x64 mm
Light aperture: 95 mm

Type: Driving lamp
Bulb type 1: H3
Bulb type 2: H3
Socket type 1: PK22s
Socket type 2: PK22s
Colour: Black
Material: Metal
Material/dome: Glass
Shape: Round
Mount.: Mounted below
E-approval: No

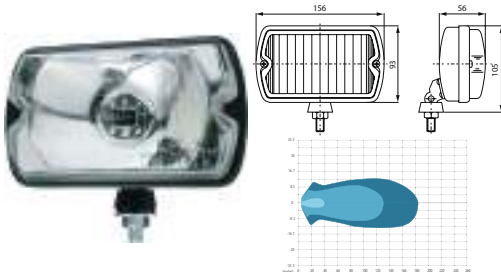
171365 Driving Lamp

Bulb incl.: No
Watt 1: 55
Watt 2: 70

Dim.: 156x105x56 mm
Light aperture:
110x75 mm

Type: Driving lamp
Bulb type 1: H3
Bulb type 2: H3
Socket type 1: PK22s
Socket type 2: PK22s
Colour: Black
Material: Metal
Material/dome: Glass
Shape: Rectangular
Mount.: Mounted below
E-approval: Yes

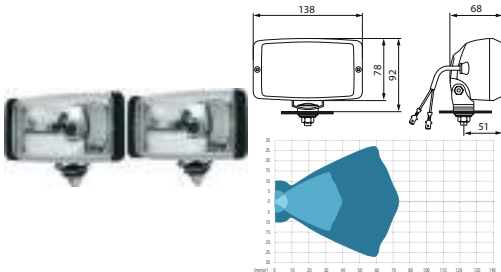
171451 Set of Driving Lamps

Bulb incl.: Yes
Voltage: 12
Watt: 55

Dim.: 138x78x68 mm
Light aperture:
110x60 mm

Type: Driving lamp
Bulb type: H3
Socket type: PK22s
Material: Shockproof plastic
Material/dome: Glass
Shape: Rectangular
Mount.: 1 bolt
Bracket: Pendant
E-approval: Yes

SPARE PARTS
170621 Light Unit

Servicing: HC-CARGO 170550

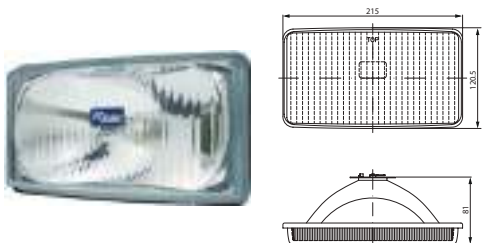

Bulb incl.: No
Watt: 55
Watt 2: 70

Dim.: 215x120.5x81 mm
Light aperture:
200x107 mm

Bulb type 1: H3
Bulb type 2: H3
Socket type: PK22s
Socket type 2: PK22s
Colour: Black
Material: Metal
Material/dome: Glass
Shape: Rectangular
Asymmetric light: w/o
E-approval: Yes

DRIVING LAMP LED

172059 LED Driving Lamp

NEW PRODUCT
www.hc-cargo.com

Voltage: 10-30
Watt: 60

Dim.: 222x177.8x79 mm

Type: LED Driving lamp
Material: Cast aluminum
Material/dome: Polycarbonate
Shape: Round
Tightness norm: IP 67
Approvals: CE
E-approval: Yes

172060 LED Driving Lamp

NEW PRODUCT
www.hc-cargo.com

Voltage: 9-36
Watt: 18

Dim.: 246.5x237x95.9 mm
Cable length: 300 mm

Type: LED Driving lamp
Material: Aluminium
Material/dome: Polycarbonate
Shape: Round
Tightness norm: IP 69K
Approvals: CE
E-approval: Yes

LED DAYTIME RUNNING LIGHT SETS

171740 Daytime Running Light

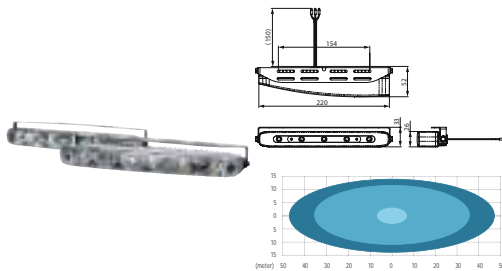

Voltage: 12/24
Watt: 2x5

Dim.: 220x33x26 mm
Cable length: 500 mm
Dist. mount. holes: 215 mm

Type: LED
Material: ABS plastic
Material/dome: PMMA
Shape: Rectangular
Mount.: Bracket
Bracket: Adjustable
No./lamps: 2
Fixing screw: 4
No./LEDs: 2x5
E-approval: Yes

POSITION LAMPS CONVENTIONAL

170875 Position Lamp

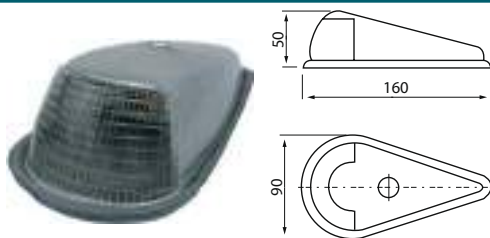

Voltage: 12/24
Watt: 5

Dim.: 160x59x45 mm
Dist. mount. holes: 57 mm

Colour/glass: White
Material: Plastic
Fixing screw: 2

170881 Position Lamp

Lens: HC-CARGO 170976.

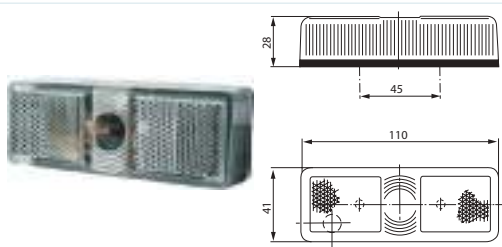

Watt: 5

Dim.: 110x41x28 mm
Dist. mount. holes: 45 mm

Socket type: S8.5
Colour/glass: White
Material: Shockproof plastic
Shape: Rectangular
Reflector: w/
Fixing screw: 2
Sidemarker lamp: w/
Tail light: w/
E-approval: Yes

170887 Position Lamp

Lens: HC-CARGO 170952.

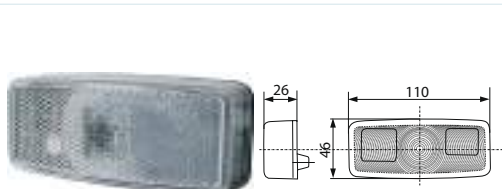

Watt: 5

Dim.: 110x46x26 mm
Dist. mount. holes: 85 mm

Socket type: T10
Colour/glass: White
Material: Shockproof plastic
Shape: Rectangular
Reflector: w/
Fixing screw: 2
Sidemarker lamp: w/
Tail light: w/
E-approval: Yes

171171 Position Lamp

Lens: HC-CARGO 171238.

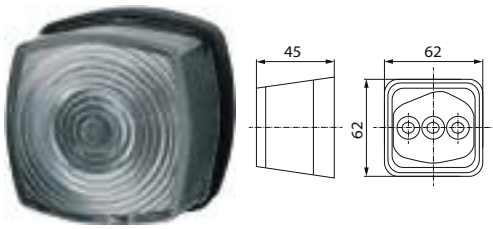

Watt: 5

Dim.: 62x62x45 mm
Dist. mount. holes:
30 mm

Socket type: S8.5
Colour: Black
Colour/glass: Transparent
Material: Shockproof plastic
Fixing screw: 2
E-approval: Yes

171179 Position Lamp



Watt: 5

Dim.: 70x36 mm
Dist. mount. holes:
33 mm

Type: Position lamp
Socket type: S8.5
Colour/glass: White
Material: Steel
Shape: Circular
Fixing screw: 2
E-approval: Yes

171182 Position Lamp

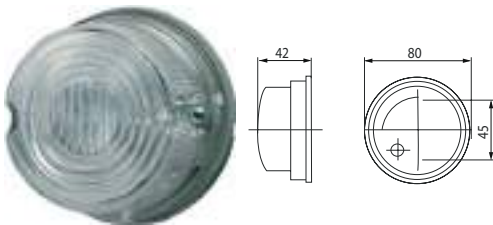

Watt: 5

Dim.: 80x42 mm
Dist. mount. holes:
45 mm

Position lamp
Socket type: S8.5
Colour/glass: White
Material: Shockproof plastic
Shape: Circular
Fixing screw: 2
E-approval: Yes

171332 Position Lamp

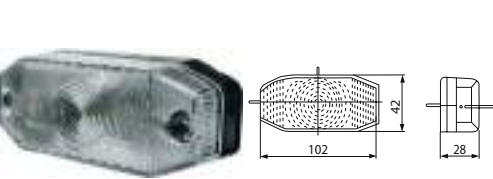

Watt: 5

Dim.: 102x42x28 mm
Dist. mount. holes:
65 mm

Socket type: S8.5
Colour: Black
Colour/glass: White
Material: Plastic
Fixing screw: 2
E-approval: Yes

171493 Position Lamp

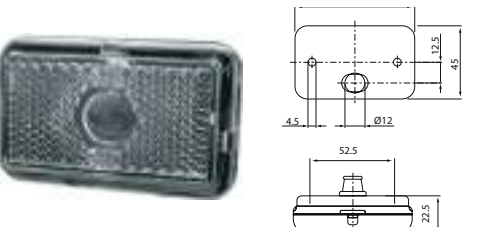

Watt: 5

Dim.: 74x45x22.5 mm
Dist. mount. holes:
52 mm

Socket type: S8.5
Colour: Black
Colour/glass: White
Material: Plastic
Shape: Rectangular
Reflector: w/
Fixing screw: 2
E-approval: Yes

SPARE PARTS

170952 Lens

Servicing: HC-CARGO 170887



Dim.: 110x46x26 mm

Shape: Rectangular





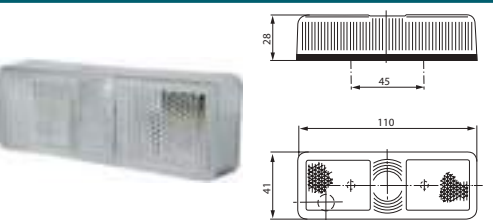





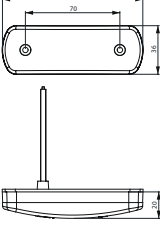

170976 Lens

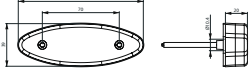
Servicing: HC-CARGO 170881

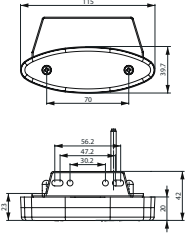

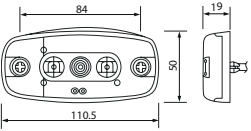
Dim.: 110x41x28 mm

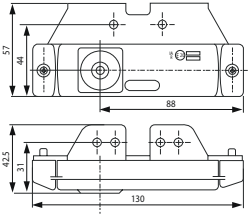
Shape: Rectangular

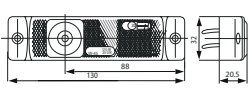
EL. SPECIFICATIONS	DIMENSIONS	ADDITIONAL SPECIFICATIONS
Servicing: HC-CARGO 171174		
171242 Lens 	Dim.: 62x62x46 mm	Shape: Square
POSITION LAMPS LED		
171603 LED Position Lamp		
 	Voltage: 24 Watt: 1.02 Dim.: 104x36x20 mm Cable length: 500 mm Dist. mount. holes: 70 mm	Type: LED Colour/glass: White Material: Shockproof plastic Shape: Rectangular Reflector: w/ Fixing screw: 2 Sidemarker: w/ No./LEDs: 1 Approvals: ADR E-approval: Yes
171609 LED Position Lamp		
 	Voltage: 24 Watt: 0.44 Dim.: 114x39x20 mm Cable length: 500 mm Dist. mount. holes: 70 mm	Type: LED Colour/glass: White Material: Shockproof plastic Reflector: w/ Fixing screw: 2 Sidemarker: w/ No./LEDs: 1 E-approval: Yes
171610 LED Position Lamp		
 	Voltage: 24 Watt: 0.44 Dim.: 115x39.7x20 mm Cable length: 500 mm Dist. mount. holes: 52 mm	Type: LED Colour/glass: White Material: Shockproof plastic Shape: Oval Bracket: Angled Reflector: w/ Fixing screw: 2 Sidemarker: w/ No./LEDs: 1 E-approval: Yes
171638 LED Position Lamp		
 	Voltage: 9-36 Watt: 0.9 Dist. mount. holes: 83 mm	Type: LED Colour/glass: White Reflector: w/ Sidemarker: w/ No./LEDs: 3 Approvals: ADR E-approval: Yes
171717 LED Position Lamp		
 	Voltage: 12/24 Watt: 0.4/0.8 Dim.: 130x57x42.5 mm	Type: LED Socket type: LED Colour/glass: White Material: Shockproof plastic Bracket: Angled Reflector: w/ Sidemarker: w/ No./LEDs: 1 E-approval: Yes
171718 LED Position Lamp		
 	Voltage: 12/24 Watt: 0.4/0.8 Dim.: 130x32x20.5 mm	Type: LED Socket type: LED Colour/glass: White Material: Shockproof plastic Reflector: w/ Sidemarker: w/ No./LEDs: 1 E-approval: Yes

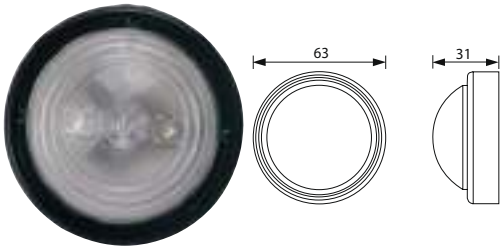
171744 LED Position Lamp

Voltage: 9-36

Dim.: 63x31 mm
OD: 63 mm
Cable length: 300 mm
Dist. mount. holes: 30 mm

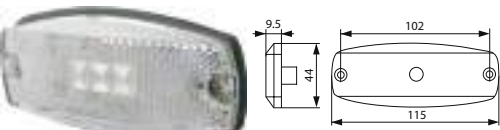
Type: LED
Colour: Black
Colour/glass: Transparent
Material: PVC
Material/dome: PMMA
Shape: Round
Mount.: 2 screws
Sidemarkers: w/
No./LEDs: 3
Approvals: ADR/SAE
E-approval: Yes

171841 LED Position Lamp

Voltage: 12/24
Watt: 0.45-1.6

Dim.: 115x44x9.5 mm
Cable length: 5000 mm
Dist. mount. holes: 102 mm

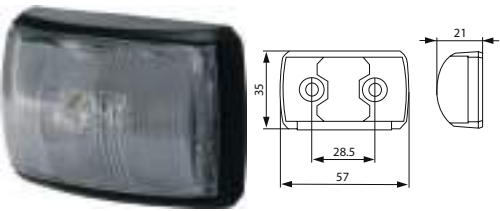
Type: LED
Colour: White
Colour/glass: White
Material: Polycarbonate
Material/dome: Polycarbonate
Shape: Rectangular
Mount.: 2 screws
Reflector: w/
Sidemarkers: w/
No./LEDs: 3
Tightness norm: IP 67
Approvals: SAE
E-approval: Yes

171844 LED Position Lamp

Voltage: 12/24

Dim.: 57x35x21 mm
Cable length: 400 mm
Dist. mount. holes: 28 mm

Type: LED
Colour: Black
Colour/glass: White
Shape: Rectangular
Fixing screw: 2
Sidemarkers: w/
No./LEDs: 2
Tightness norm: IP 67
E-approval: Yes

171862 LED Position Lamp

Voltage: 12/24
Watt: 0.3-0.6

Dim.: 72x26x24 mm
Cable length: 5000 mm
Dist. mount. holes: 61 mm

Type: LED
Colour: Black
Colour/glass: White
Material: PP
Material/dome: PMMA
Shape: Rectangular
Sidemarkers: w/
No./LEDs: 3
Approvals: CE
E-approval: Yes

171868 LED Position Lamp

Voltage: 12/24
Watt: 0.3-0.6

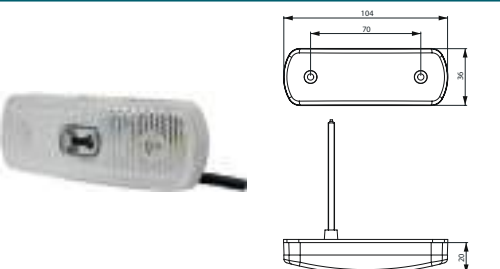

Dim.: 72x26x24 mm
Cable length: 5000 mm
Dist. mount. holes: 61 mm

Type: LED
Colour: Black
Colour/glass: White
Material: PP
Material/dome: PMMA
Shape: Rectangular
Bracket: Adjustable
Sidemarkers lamp: w/
No./LEDs: 3
Approvals: CE
E-approval: Yes

172038 LED Position Lamp

Voltage: 12/24
Watt: 0.49

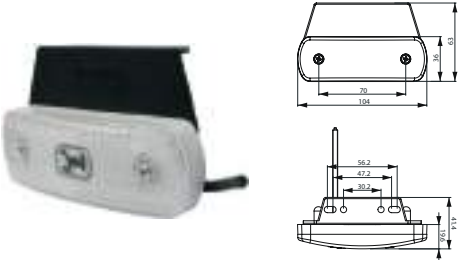
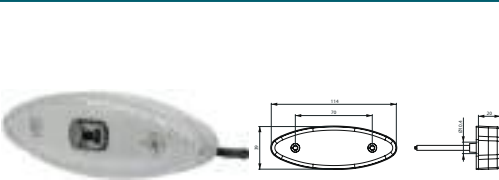
Dim.: 104x36x20 mm
Cable length: 500 mm
Dist. mount. holes: 70 mm

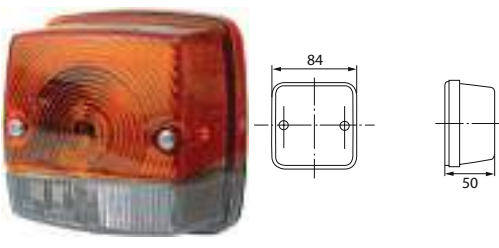
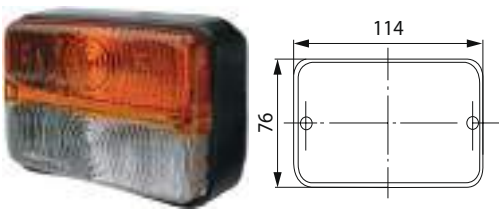
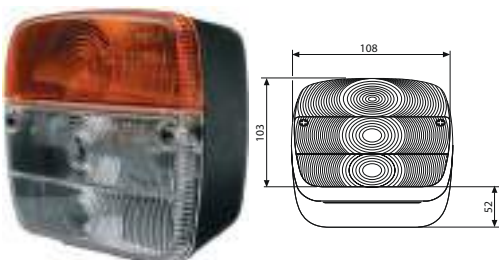
Type: LED
Colour/glass: White
Material: Shockproof plastic
Shape: Rectangular
Reflector: w/
Fixing screw: 2
Sidemarkers: w/
No./LEDs: 1
E-approval: Yes

	EL. SPECIFICATIONS	DIMENSIONS	ADDITIONAL SPECIFICATIONS
172039 LED Position Lamp		Voltage: 12/24 Watt: 0.49 Dim.: 104 x 36 x 19.6 mm Cable length: 500 mm Dist. mount. holes: 52 mm	Type: LED Colour/glass: White Material: Shockproof plastic Bracket: Angled Reflector: w/ Fixing screw: 2 Sidemarker: w/ No./LEDs: 1 E-approval: Yes
172043 LED Position Lamp		Voltage: 12/24 Watt: 0.44 Dim.: 114x39x20 mm Cable length: 500 mm Dist. mount. holes: 70 mm	Type: LED Colour/glass: White Material: Shockproof plastic Reflector: w/ Fixing screw: 2 Sidemarker: w/ No./LEDs: 1 E-approval: Yes
172044 LED Position Lamp		Voltage: 12/24 Watt: 0.44 Dim.: 115x39.7x20 mm Cable length: 500 mm Dist. mount. holes: 52 mm	Type: LED Colour/glass: White Material: Shockproof plastic Shape: Oval Bracket: Angled Reflector: w/ Fixing screw: 2 Sidemarker: w/ No./LEDs: 1 E-approval: Yes
FLASHER-POSITION LAMPS CONVENTIONAL			
170925 Flasher/Position Lamp		Watt 1: 21 Watt 2: 5 Dim.: 84x50 mm Dist. mount. holes: 45 mm	Socket type 1: BA15S Socket type 2: S8.5 Material: Shockproof plastic Shape: Square Fixing screw: 2 RH/LH: RH/LH E-approval: Yes
170927 Flasher/Position Lamp	<i>Lens: HC-CARGO 170989.</i>		
	Watt 1: 21 Watt 2: 5 Dim.: 114x76 mm Dist. mount. holes: 58 mm	Socket type 1: BA15S Socket type 2: BA15S Material: Shockproof plastic Shape: Rectangular Fixing screw: 2 RH/LH: RH/LH E-approval: Yes	
170941 Flasher/Position Lamp	<i>Servicing: HC-CARGO 170828</i>		
	Watt 1: 21 Watt 2: 5 Dim.: 108x103x52 mm Dist. mount. holes: 55 mm	Socket type 1: BA15S Socket type 2: S8.5 Material: Shockproof plastic Shape: Rectangular Fixing screw: 2 Flasher light: w/ Sidemarker: w/ RH/LH: RH/LH E-approval: Yes	

171215 Flasher/Position Lamp

Lens: HC-CARGO 171248.

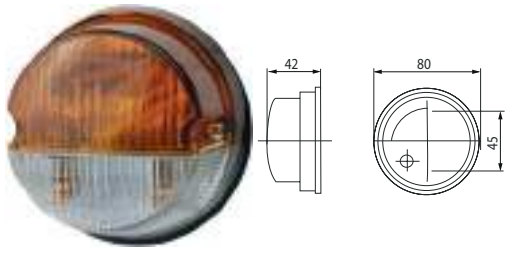

Watt 1: 18
Watt 2: 10

Dim.: 80x42 mm
Dist. mount. holes:
45 mm

Socket type 1: S8.5
Socket type 2: S8.5
Material: Metal
Shape: Circular
Fixing screw: 2
RH/LH: RH/LH
E-approval: Yes

171217 Flasher/Position Lamp

Right: HC-CARGO 171260.

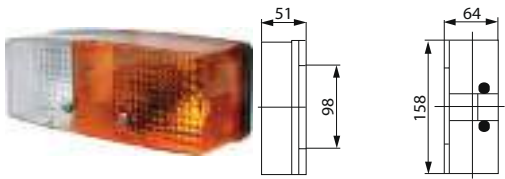

Watt 1: 21
Watt 2: 5

Dim.: 158x64x51 mm
Dist. mount. holes:
98/45 mm

Socket type 1: BA15S
Socket type 2: BA15S
Material: Shockproof plastic
Shape: Rectangular
Fixing screw: 4
RH/LH: LH
E-approval: Yes

171218 Flasher/Position Lamp

Left: HC-CARGO 171217.

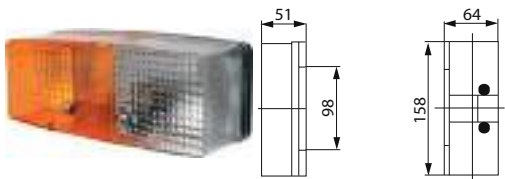

Watt 1: 21
Watt 2: 5

Dim.: 158x64x51 mm
Dist. mount. holes:
98/45 mm

Socket type 1: BA15S
Socket type 2: BA15S
Material: Shockproof plastic
Shape: Rectangular
Fixing screw: 4
RH/LH: RH
E-approval: Yes

171510 Flasher/Position Lamp

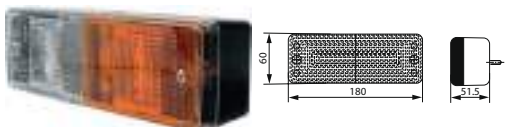

Watt 1: 21
Watt 2: 5

Dim.: 180x60x51.5 mm
Dist. mount. holes:
134 mm

Socket type 1: BA15S
Socket type 2: BA15S
Material: Shockproof plastic
Shape: Rectangular
Fixing screw: 2
RH/LH: RH/LH
E-approval: Yes

SPARE PARTS

170834 Lens, Rear Lamp

Servicing: HC-CARGO 170941



Dim.: 108x103x52 mm

Shape: Rectangular
Fixing screw: 2
Flasher light: w/
Sidemarker: w/

170989 Lens

Servicing: HC-CARGO 170927



Dim.: 114x76 mm

Shape: Rectangular

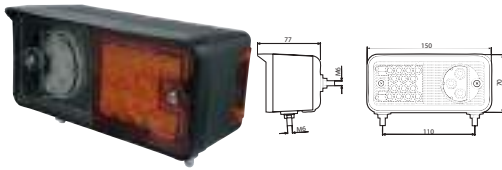
FLASHER-POSITION LAMPS LED
171800 LED Flasher/Positions Lamp

Voltage: 12/24

 Dim.: 150x70x77 mm
 Cable length: 2100 mm
 Dist. mount. holes:
 110/55 mm

 Colour: Black
 Material: Shockproof plastic
 Shape: Rectangular
 Mount.: Upright/pendant
 Fixing screw: 2
 No./LEDs: 14/3
 RH/LH: LH
 E-approval: Yes

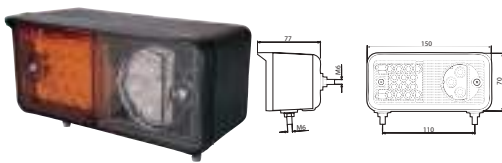
171801 LED Flasher/Positions Lamp

Voltage: 12/24

 Dim.: 150x70x77 mm
 Cable length: 2100 mm
 Dist. mount. holes:
 110/55 mm

 Colour: Black
 Material: Shockproof plastic
 Shape: Rectangular
 Mount.: Upright/pendant
 Fixing screw: 2
 No./LEDs: 14/3
 RH/LH: RH
 E-approval: Yes

SIDE INDICATORS CONVENTIONAL
170713 Flasher Lamp

Lens: HC-CARGO 170670, 170671.



Watt: 5

 Dim.: 108x84x93 mm
 OD: 60 mm

 Socket type: BA15S
 Colour/glass: Orange
 E-approval: Yes

171140 Flasher Lamp

Servicing: Fiat, Ford, Lada, Universal



Watt: 4

 OD: 27 mm
 Dist. mount. holes:
 28 mm

 Socket type: BA9s
 Colour/glass: Orange
 E-approval: Yes

171141 Flasher Lamp

Servicing: Fiat 127, 129



Dim.: 62x50x17 mm

 Colour/glass: Orange
 E-approval: Yes









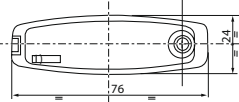

171147 Flasher Lamp

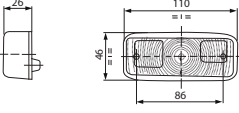
Servicing: Ford, Universal

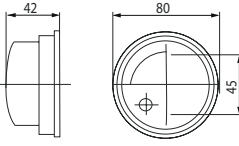

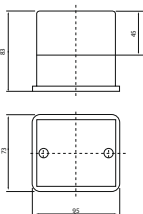
Dim.: 34x34x60 mm

 Colour/glass: Orange
 E-approval: Yes

EL. SPECIFICATIONS		DIMENSIONS	ADDITIONAL SPECIFICATIONS
171148 Flasher Lamp			
Servicing: Universal, Ford, Rover Group		Dim.: 76x24 mm	Socket type: BA9s Colour/glass: Orange E-approval: Yes
			
171153 Flasher Lamp			
Servicing: Audi, VW, various types 84		Bulb incl.: No Voltage: 12 Watt: 5	Dim.: 110x46x26 mm Dist. mount. holes: 86 mm
		Type: Flasher lamp Colour: Orange Colour/glass: Orange Material: Plastic Material/dome: Plastic Shape: Flat Mount.: Sidemounted No./lamps: 1 Flasher light: w/ RH/LH: RH/LH E-approval: Yes	
171183 Flasher Lamp			
Lens: HC-CARGO 171247.		Watt: 5	Dim.: 80x42 mm Dist. mount. holes: 45 mm
		Socket type: S8.5 Colour/glass: Orange Material: Shockproof plastic Fixing screw: 2 E-approval: Yes	
171337 Flasher Lamp			
Watt: 10		Dim.: 95x73x83 mm Dist. mount. holes: 48 mm	Socket type: BA15S Colour: Black Colour/glass: Orange Material: Plastic Shape: Rectangular Fixing screw: 2 E-approval: Yes
			
171339 Flasher Lamp			
Lens: HC-CARGO 171340.		Watt: 21	Dim.: 84x84x51 mm Dist. mount. holes: 45 mm
		Socket type: BA15S Colour/glass: Orange Material: Plastic Shape: Rectangular Fixing screw: 2 E-approval: Yes	
SPARE PARTS			
170670 Lens			
Servicing: HC-CARGO 170713			Colour/glass: Orange Material: Glass
			
170671 Bulb Holder			
Servicing: HC-CARGO 170640, 170668, 170713			
			

SIDE INDICATORS LED

171770 LED Flasher Lamp

Servicing: Fiat, Kia, MAN

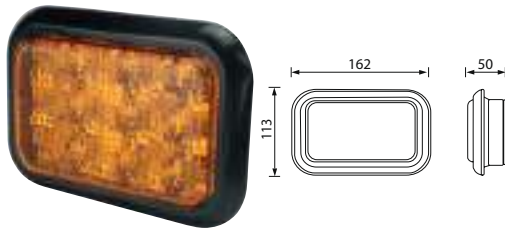

Voltage: 24
Watt: 4

Dim.: 162x113x50 mm

Type: Flasher lamp
Colour/glass: Orange
Material: ABS plastic
Material/dome: PMMA
Shape: Rectangular
Mount.: Plan installation
Flasher light: w/
No./LEDs: 16
RH/LH: RH/LH
E-approval: Yes

172036 LED Side Marker Lamp

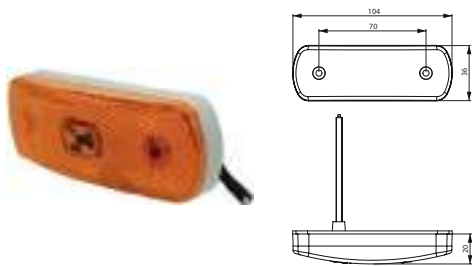

Voltage: 12/24

Dim.: 104x36x20 mm
Cable length: 500 mm
Dist. mount. holes:
70 mm

Type: LED
Colour/glass: Orange
Material: Shockproof plastic
Shape: Rectangular
Reflector: w/
Fixing screw: 2
Sidemarker lamp: w/
No./LEDs: 1
E-approval: Yes

172037 LED Side Marker Lamp

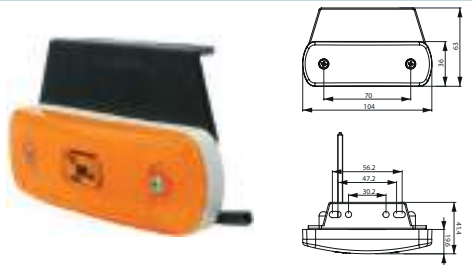

Voltage: 12/24

Dim.: 104x36x19.6 mm
Cable length: 500 mm
Dist. mount. holes:
70 mm

Type: LED
Colour/glass: Orange
Material: Shockproof plastic
Shape: Rectangular
Bracket: Angled
Reflector: w/
Fixing screw: 2
Sidemarker lamp: w/
No./LEDs: 1
E-approval: Yes

172041 LED Side Marker Lamp

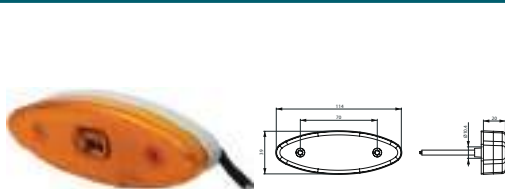

Voltage: 12/24

Dim.: 114x39x20 mm
Cable length: 500 mm
Dist. mount. holes:
70 mm

Type: LED
Colour/glass: Orange
Material: Shockproof plastic
Reflector: w/
Fixing screw: 2
Sidemarker lamp: w/
No./LEDs: 1
E-approval: Yes

172042 LED Side Marker Lamp

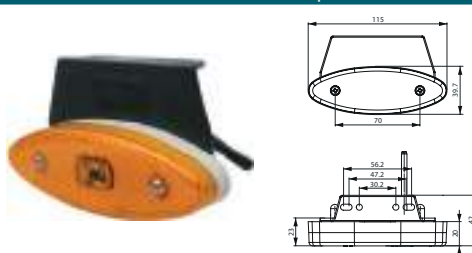

Voltage: 12/24

Dim.: 115x39.7x20 mm
Dist. mount. holes:
70 mm

Type: LED
Colour/glass: Orange
Material: Shockproof plastic
Shape: Oval
Bracket: Angled
Reflector: w/
Fixing screw: 2
Sidemarker lamp: w/
No./LEDs: 1
E-approval: Yes

SIDE MARKER LAMPS CONVENTIONAL

170880 Side Marker Lamp

Lens: HC-CARGO 170975.

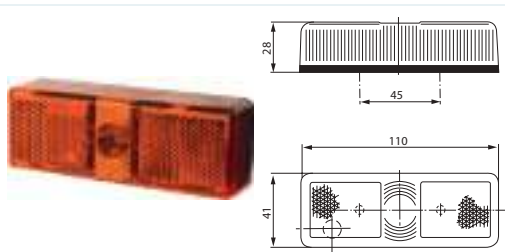

Watt: 5

Dim.: 110x41x28 mm
Dist. mount. holes:
45 mm

Socket type: S8.5
Colour: Black
Colour/glass: Orange
Material: Shockproof plastic
Shape: Rectangular
Reflector: w/
Fixing screw: 2
E-approval: Yes

170884 Side Marker Lamp

Lens: HC-CARGO 170946.

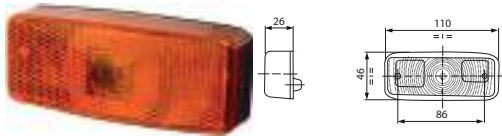

Watt: 5

 Dim.: 110x46x26 mm
 Dist. mount. holes:
 85 mm

 Socket type: T10
 Colour/glass: Orange
 Material: Shockproof plastic
 Shape: Rectangular
Reflector: w/
 Fixing screw: 2
 E-approval: Yes

170885 Side Marker Lamp

Lens: HC-CARGO 170946.



Watt: 5

 Dim.: 110x46x26 mm
 Dist. mount. holes:
 20/50 mm

 Socket type: T10
 Colour/glass: Orange
 Material: Shockproof plastic
 Shape: Rectangular
 Bracket: Angled
Reflector: w/
 E-approval: Yes

171175 Side Marker Lamp

Lens: HC-CARGO 171243.

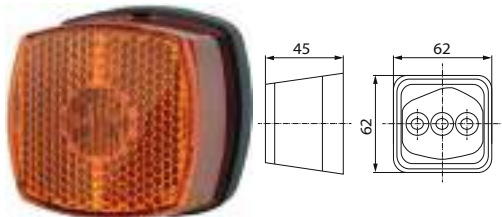

Watt: 5

 Dim.: 62x62x45 mm
 Dist. mount. holes:
 30 mm

 Socket type: S8.5
 Colour: Black
 Colour/glass: Orange
 Material: Shockproof plastic
Reflector: w/
 Fixing screw: 2
 E-approval: Yes

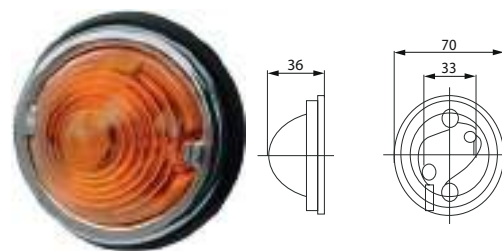
171180 Side Marker Lamp

Watt: 5

 Dim.: 70x36 mm
 Dist. mount. holes:
 33 mm

 Type: Side marker lamp
 Socket type: S8.5
 Colour/glass: Orange
 Material: Steel
 Fixing screw: 2
 E-approval: Yes

171343 Side Marker Lamp

Watt: 5

 Dim.: 74x45x22.5 mm
 Dist. mount. holes:
 52 mm

 Socket type: S8.5
 Colour: Black
 Colour/glass: Orange
 Material: Plastic
 Shape: Rectangular
 Fixing screw: 2
 E-approval: Yes

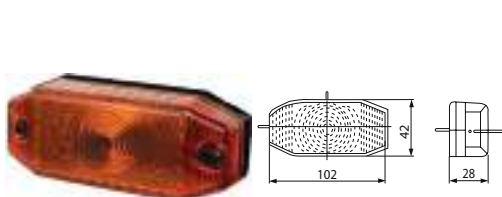
171369 Side Marker Lamp

Watt: 5

 Dim.: 102x42x28 mm
 Dist. mount. holes:
 65 mm

 Socket type: S8.5
 Colour: Black
 Colour/glass: Orange
 Material: Plastic
 Fixing screw: 2
 E-approval: Yes

SPARE PARTS

170946 Lens

Servicing: HC-CARGO 170885



Dim.: 110x46 mm

170975 Lens

Servicing: HC-CARGO 170880

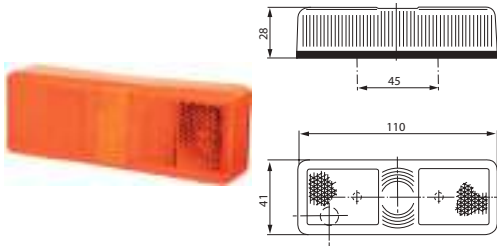

Dim.: 110x41x28 mm

ACCESSORIES

171417 Angle Bracket

Long.



Mount hole: 45 mm
Mount. hole 2: 85 mm

171419 Angle Bracket

Short.



Mount hole: 45 mm
Mount. hole 2: 85 mm

SIDE MARKER LAMPS LED

171602 LED Side Marker Lamp

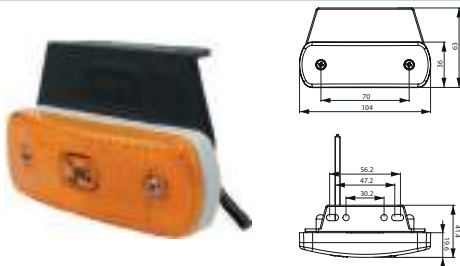

Voltage: 24

Dim.: 104x36x19.6 mm
Cable length: 500 mm
Dist. mount. holes:
70 mm

Type: LED
Colour/glass: Orange
Material: Shockproof plastic
Shape: Rectangular
Bracket: Angled
Reflector: w/
Fixing screw: 2
Sidemarker lamp: w/
No./LEDs: 1
Approvals: ADR
E-approval: Yes



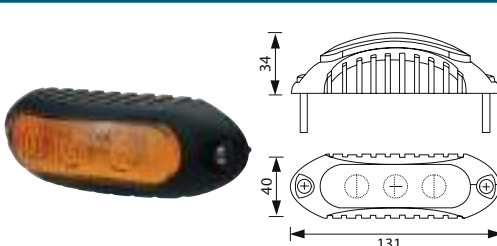





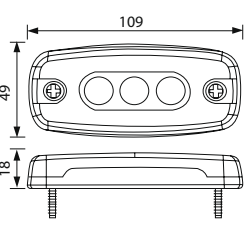

171618 LED Side Marker Lamp

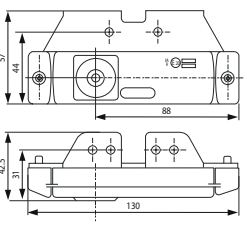

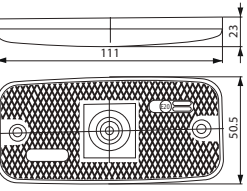
Voltage: 9-36

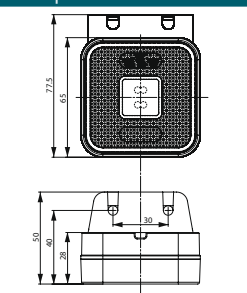
Dim.: 131x40x34 mm
Cable length: 28 mm
Dist. mount. holes:
115 mm

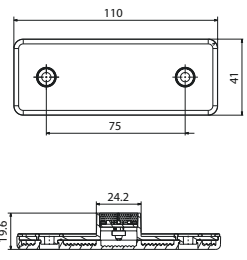
Type: LED
Colour: Yellow
Colour/glass: Orange
Material: PP/PMMA
Material/dome: ABS plastic
Mount.: Screw fastening
No./lamps: 1
Fixing screw: 2
Sidemarker lamp: w/
No./LEDs: 3
Wiring system: w/
E-approval: Yes

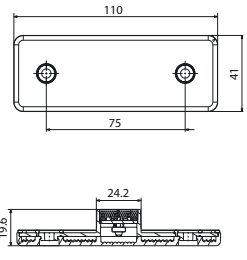
	EL. SPECIFICATIONS	DIMENSIONS	ADDITIONAL SPECIFICATIONS
171636 LED Side Marker Lamp  	Voltage: 9-36 Watt: 0.9	Dim.: 109x49x18 mm Dist. mount. holes: 83 mm	Type: LED Colour/glass: Orange Shape: Rectangular Reflector: w/ Sidemarker lamp: w/ No./LEDs: 3 E-approval: Yes
171721 LED Side Marker Lamp  	Voltage: 12/24	Dim.: 130x57x42.5 mm Dist. mount. holes: 50 mm	Type: LED Socket type: LED Material: Shockproof plastic Shape: Rectangular Bracket: Angled Reflector: w/ Sidemarker lamp: w/ No./LEDs: 1 E-approval: Yes
171722 LED Side Marker Lamp  	Voltage: 12/24	Dim.: 111x50.5x23 mm Dist. mount. holes: 116 mm	Type: LED Socket type: LED Colour/glass: Orange Material: Shockproof plastic Shape: Rectangular Mount.: Flat w/ 2 fixing holes Reflector: w/ Fixing screw: 2 Sidemarker lamp: w/ No./LEDs: 1 E-approval: Yes
171729 LED Side Marker Lamp  	Servicing: MAN Voltage: 12/24 Watt: 1	Dim.: 65x65x28 mm Dist. mount. holes: 30 mm	Type: LED Colour/glass: Orange Material: ABS plastic Material/dome: PMMA Shape: Square Bracket: Angled Reflector: w/ Sidemarker lamp: w/ No./LEDs: 2 E-approval: Yes
171735 LED Side Marker Lamp  	Voltage: 12	Dim.: 110x41x19.6 mm Cable length: 200 mm Dist. mount. holes: 75 mm	Type: LED Shape: Rectangular Sidemarker lamp: w/ No./LEDs: 1 E-approval: Yes
171736 LED Side Marker Lamp  	Voltage: 24	Dim.: 110x41x19.6 mm Cable length: 20 mm Dist. mount. holes: 75 mm	Type: LED Shape: Rectangular Sidemarker lamp: w/ No./LEDs: 1 E-approval: Yes

	EL. SPECIFICATIONS	DIMENSIONS	ADDITIONAL SPECIFICATIONS
171742 LED Side Marker Lamp			
	Voltage: 12/24	Dim.: 63x31 mm OD: 63 mm Cable length: 300 mm	Type: LED Colour: Black Colour/glass: Orange Material: PVC Material/dome: PMMA Mount.: 2 screws Sidemarkers lamp: w/ No./LEDs: 3 Approvals: ADR/SAE E-approval: Yes
171835 LED Adapter			
Servicing: HC-CARGO 171836, 193119 HC-CARGO 171835 is the LED version of HC-CARGO 170763.			
	Voltage: 12/24		
171839 LED Side Marker Lamp			
	Voltage: 12/24 Watt: 0.45-1.6	Dim.: 115x44x9.5 mm Cable length: 5000 mm Dist. mount. holes: 102 mm	Type: LED Colour: White Colour/glass: Orange Material: Polycarbonate Material/dome: Polycarbonate Shape: Rectangular Mount.: 2 screws Reflector: w/ Sidemarkers lamp: w/ No./LEDs: 3 Tightness norm: IP 67 Approvals: SAE E-approval: Yes
171842 LED Side Marker Lamp			
	Voltage: 12/24	Dim.: 57x35x21 mm Cable length: 400 mm Dist. mount. holes: 28.5 mm	Type: LED Colour: Black Colour/glass: Orange Material: ASA plastic Material/dome: PMMA Shape: Rectangular Fixing screw: 2 Sidemarkers lamp: w/ No./LEDs: 2 Tightness norm: IP 67 E-approval: Yes
171860 LED Side Marker Lamp			
	Voltage: 12/24 Watt: 0.3-0.6	Dim.: 72x26x24 mm Cable length: 5000 mm Dist. mount. holes: 61 mm	Type: LED Colour: Black Colour/glass: Orange Material: PP Material/dome: PMMA Shape: Rectangular Fixing screw: 2 Sidemarkers lamp: w/ No./LEDs: 3 Approvals: CE E-approval: Yes
171956 LED Side Marker Lamp			
	Voltage: 12-24 Watt: 1	Dim.: 65x65x28 mm Cable length: 220 mm Dist. mount. holes: 30 mm	Type: LED Colour/glass: White Material: ABS plastic Material/dome: PMMA Shape: Square Bracket: Angled Reflector: w/ Sidemarkers lamp: w/ No./LEDs: 2 Tightness norm: IP 68 E-approval: Yes

ACCESSORIES
171639 Angle Bracket

Servicing: HC-CARGO 171636, 171637, 171638

171836 Lens

Servicing: HC-CARGO 171835

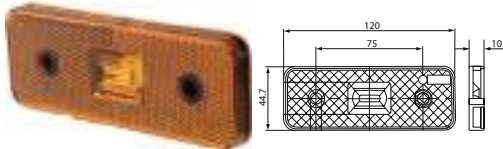

Dim.: 120x44.7x10 mm

 Shape: Square
E-approval: Yes

193119 Junior Power Timer Connector

Servicing: HC-CARGO 171835, 171836

Terminal: HC-CARGO 192175, 192176, 192177, 192178, 192179.

 Type/terminal: Junior Power Timer
Colour: Black
No./poles: 2
Plug: Female

TAIL LIGHTS
REVERSING LAMPS CONVENTIONAL
170689 Reversing Lamp

Watt: 21

 Dim.: 129x75x55 mm
Dist. mount. holes:
56 mm

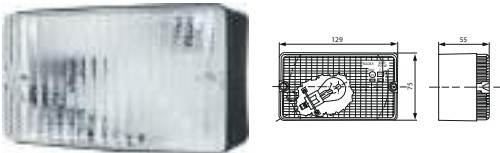
 Socket type: BA15S
Shape: Rectangular
Bracket: Straight
Fixing screw: 1
Reverse light: w/
E-approval: Yes

170934 Reversing Lamp

Watt: 21

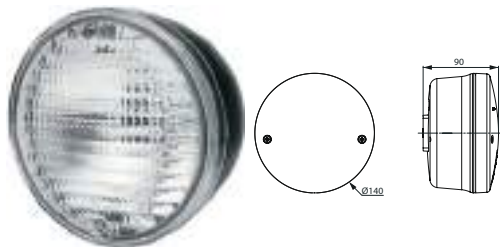
 Dim.: 140x90 mm
Dist. mount. holes:
45 mm

 Socket type: BA15S
Colour: Black
Material: Shockproof plastic
Shape: Round
Fixing screw: 2
Reverse light: w/
Wiring system: w/
E-approval: Yes

170935 Reversing Lamp

Watt: 21

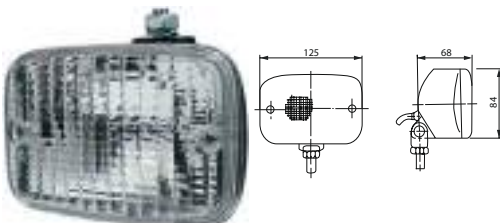
Dim.: 125x84x68 mm

 Socket type: BA15S
Colour: Black
Material: Shockproof plastic
Shape: Rectangular
Bracket: Pendant
Fixing screw: M10
Reverse light: w/
E-approval: Yes

171222 Reversing Lamp



Bulb incl.: No
Voltage: 12/24
Watt: 55
Watt 2: 70

Dim.: 140x90 mm
Dist. mount. holes:
45 mm

Bulb type: H3
Bulb type 2: H3
Socket type: PK22s
Socket type 2: PK22s
Colour: Black
Material: Shockproof plastic
Shape: Circular
Fixing screw: 2
Wiring system: w/
E-approval: Yes

172014 Reversing Lamp

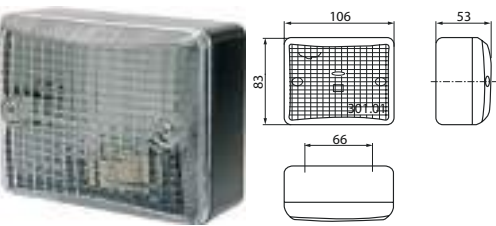

Bulb incl.: No
Watt: 21

Dim.: 106x83x53 mm
Dist. mount. holes:
66 mm

Socket type: BA15S
Colour: Black
Colour/glass: White
Material: ABS plastic
Material/dome: PMMA
Shape: Rectangular
Fixing screw: 2
Reverse light: w/
Approvals: CE
E-approval: Yes

REVERSING LAMPS LED

170909 LED Fog/Reverse Lamp

Lens and o-ring: HC-CARGO 170910.



Voltage: 12/24

Dim.: 140x88.3 mm
OD: 140 mm
Dist. mount. holes:
45 mm

Type: LED
Colour/glass: White
Material: Shockproof plastic
Shape: Round
Fixing screw: 2
Rear/fog lamp: w/
Tail light: w/
LEDs: w/
No./LEDs: 4
E-approval: Yes

171684 LED Reversing Lamp

Can be flush mounted by using HC-CARGO 171266.

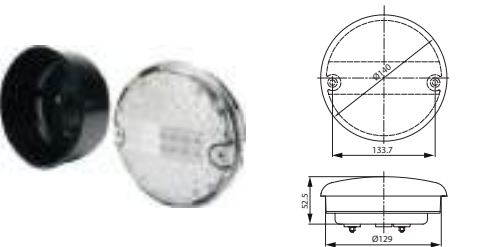

Voltage: 9-33
Watt: 8

Dim.: 140x52.5 mm
Dist. mount. holes:
45 mm

Type: Reversing lamp
Colour: Transparent
Material: Shockproof plastic
Shape: Circular
No./LEDs: 61
Approvals: ECE R23
E-approval: Yes

171726 LED Fog/Reverse Lamp

Ring: clear, center: red.

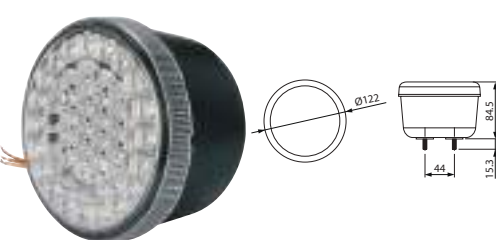

Voltage: 12/24

Dim.: 122x84.5 mm
OD: 122 mm
Cable length: 150 mm
Dist. mount. holes:
44 mm

Type: LED
Material: Shockproof plastic
Material/dome: Shockproof plastic
Shape: Round
Rear/fog lamp: w/
Reverse light: w/
No./LEDs: 38
E-approval: Yes

172007 LED Reversing Lamp



Voltage: 10-30
Watt: 18

Dim.: 89x58 mm

Type: Reversing lamp
Bulb type: 6 LED
Material: Cast aluminum
Material/dome: Polycarbonate
Shape: Round
Reverse light: w/
Tightness norm: IP 67
Approvals: ECE R23
E-approval: Yes

SPARE PARTS
170910 Lens, Rear Lamp

Servicing: HC-CARGO 170909

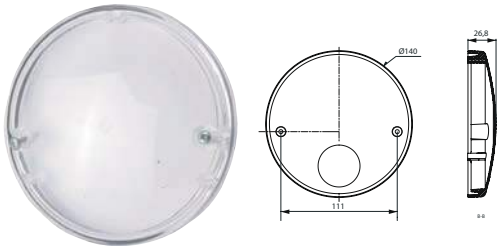
 Dim.: 140x26.8 mm
 Dist. mount. holes:
 111 mm

 Colour: White
 Shape: Round

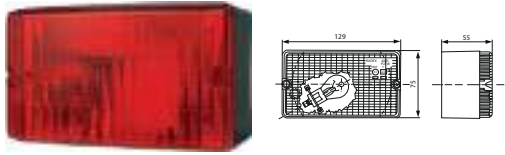
REAR FOG LAMPS CONVENTIONAL
170688 Rear Fog Lamp

Watt: 21

 Dim.: 129x75x55 mm
 Dist. mount. holes:
 56 mm

 Socket type: BA15S
 Shape: Rectangular
 Bracket: Straight
 Rear/fog lamp: w/
 E-approval: Yes

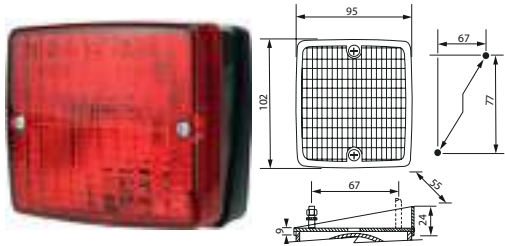
170928 Rear Fog Lamp

Watt: 21

 Dim.: 102x95x55 mm
 Dist. mount. holes:
 77 mm

 Socket type: BA15S
 Colour: Black
 Material: Shockproof plastic
 Shape: Rectangular
 Fixing screw: 2
 E-approval: Yes

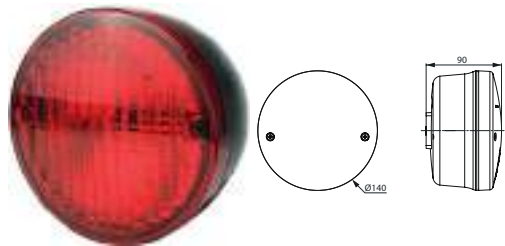
170929 Rear Fog Lamp

 Bulb incl.: No
 Watt: 21

 Dim.: 140x90 mm
 Dist. mount. holes:
 45 mm

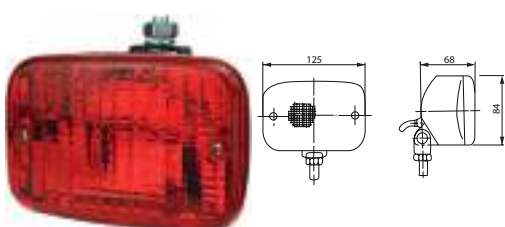
 Socket type: BA15S
 Colour: Black
 Material: Shockproof plastic
 Fixing screw: 2
 Rear/fog lamp: w/
 Wiring system: w/
 E-approval: Yes

170930 Rear Fog Lamp

Watt: 21

Dim.: 125x84x68 mm

 Socket type: BA15S
 Colour: Black
 Material: Shockproof plastic
 Bracket: Pendant
 Fixing screw: 1
 Rear/fog lamp: w/
 E-approval: Yes

171220 Rear Fog Lamp

w/ Grommet.

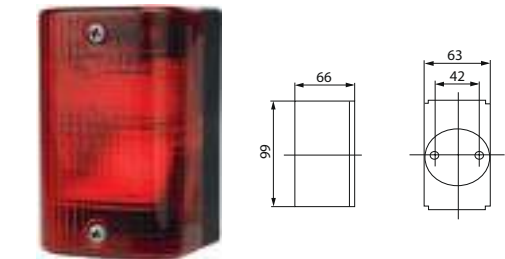

Watt: 21

 Dim.: 63x99x66 mm
 Dist. mount. holes:
 42 mm

 Socket type: BA15S
 Material: Shockproof plastic
 Shape: Rectangular
 Sidemarker: w/
 E-approval: Yes

REAR FOG LAMPS LED

170909 LED Fog/Reverse Lamp

Lens and o-ring: HC-CARGO 170910.

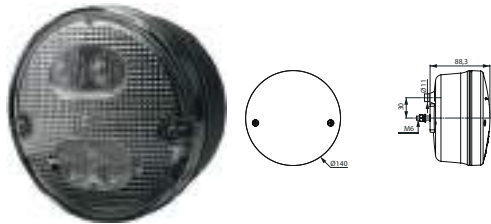

Voltage: 12/24

Dim.: 140x88.3 mm
OD: 140 mm
Dist. mount. holes:
45 mm

Type: LED
Colour/glass: White
Material: Shockproof plastic
Shape: Round
Fixing screw: 2
Rear/fog lamp: w/
Tail light: w/
LEDs: w/
No./LEDs: 4
E-approval: Yes

171685 LED Rear Fog Lamp

Can be flush mounted by using HC-CARGO 171266.

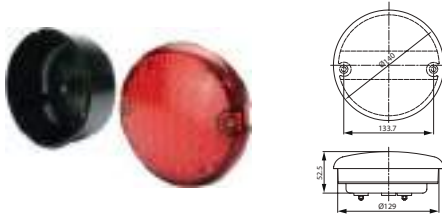

Voltage: 9-33

Dim.: 140x52.5 mm
Dist. mount. holes:
45 mm

Type: Rear fog lamp
Colour: Red
Material: Shockproof plastic
Shape: Circular
Rear/fog lamp: w/
No./LEDs: 61

171726 LED Fog/Reverse Lamp

Ring: clear, center: red.

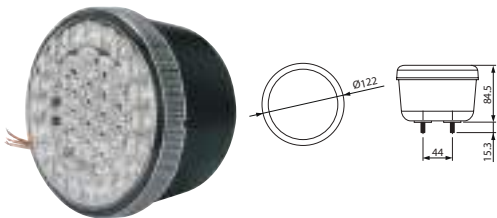

Voltage: 12/24

Dim.: 122x84.5 mm
OD: 122 mm
Cable length: 150 mm
Dist. mount. holes:
44 mm

Type: LED
Material: Shockproof plastic
Material/dome: Shockproof plastic
Rear/fog lamp: w/
Reverse light: w/
No./LEDs: 38
E-approval: Yes

SPARE PARTS

170910 Lens, Rear Lamp

Servicing: HC-CARGO 170909

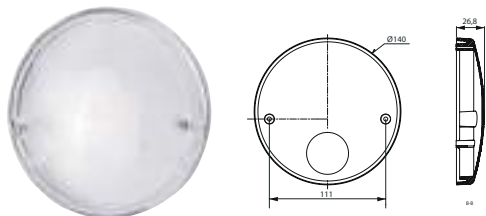

Dim.: 140x26.8 mm
Dist. mount. holes:
111 mm

Colour: White
Shape: Round

MULTI FUNCTION LAMPS

TRAILER LAMPS CONVENTIONAL

170685 Multi Function Lamp

Lens: HC-CARGO 170687.



Bulb incl.: No
Watt 1: 21
Watt 2: 21/5

Dim.: 104x98x50 mm
Dist. mount. holes:
45/55 mm

Socket type 1: BA15S
Socket type 2: BAY15d
Material: Shockproof plastic
Fixing screw: 2
Flasher light: w/
Numberplate light: Yes/No
Tail light: w/
Stop light: w/
RH/LH: RH/LH
E-approval: Yes

170846 Multi Function Lamp

Lens: HC-CARGO 170847.

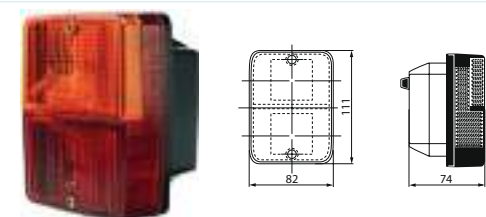

Watt 1: 10
Watt 2: 21/5

Dim.: 111x82x74 mm
Dist. mount. holes:
57/87 mm

Socket type 1: BA15S
Socket type 2: BAY15d
Material: Shockproof plastic
Fixing screw: 4
Flasher light: w/
Tail light: w/
Stop light: w/
RH/LH: RH/LH
E-approval: Yes

170939 Multi Function Lamp

Servicing: HC-CARGO 170809, 170818, 170828, 170829, 170835, 171049

Lens: HC-CARGO 170833.

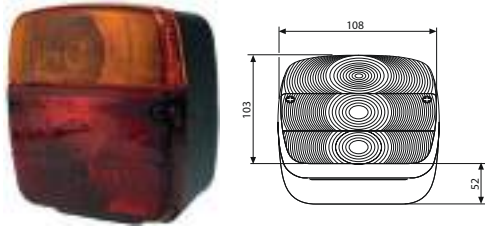

Bulb incl.: No
Watt 1: 21
Watt 2: 21/5

Dim.: 108x103x52 mm
Dist. mount. holes:
45/55 mm

Socket type 1: BA15S
Socket type 2: BAY15d
Material: Shockproof plastic
Fixing screw: 2
Flasher light: w/
Tail light: w/
Stop light: w/
RH/LH: RH/LH
E-approval: Yes

170940 Multi Function Lamp

Servicing: HC-CARGO 170829

Lens: HC-CARGO 170833.

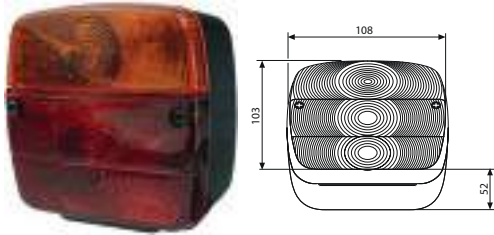

Bulb incl.: No
Watt 1: 21
Watt 2: 21/5

Dim.: 108x103x52 mm
Dist. mount. holes:
45/55 mm

Socket type 1: BA15S
Socket type 2: BAY15d
Material: Shockproof plastic
Fixing screw: 2
Flasher light: w/
Numberplate light: w/
Tail light: w/
Stop light: w/
RH/LH: RH/LH
E-approval: Yes

170943 Multi Function Lamp

Lens: HC-CARGO 170944.

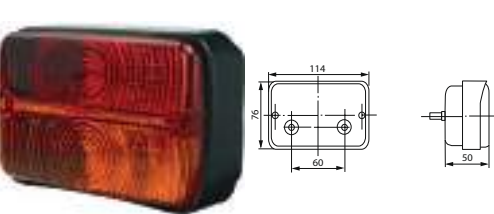

Bulb incl.: No
Watt 1: 21
Watt 2: 21/5

Dim.: 114x76x50 mm
Dist. mount. holes:
60 mm

Socket type 1: BA15S
Socket type 2: BAY15d
Material: Shockproof plastic
Shape: Rectangular
Fixing screw: 2
Flasher light: w/
Tail light: w/
Stop light: w/
RH/LH: RH/LH
E-approval: Yes

170985 Multi Function Lamp

Lens: HC-CARGO 170987.

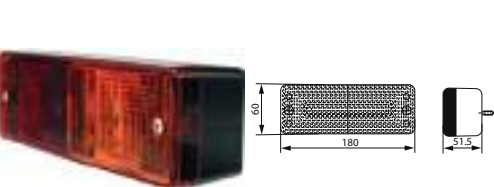

Bulb incl.: No
Watt 1: 10
Watt 2: 21/5

Dim.: 180x60x51.5 mm
Dist. mount. holes:
134 mm

Socket type 1: BA15S
Socket type 2: BAY15d
Material: Shockproof plastic
Shape: Rectangular
Fixing screw: 2
Flasher light: w/
Tail light: w/
Stop light: w/
RH/LH: RH/LH
E-approval: Yes

170986 Multi Function Lamp

Lens: HC-CARGO 170987.

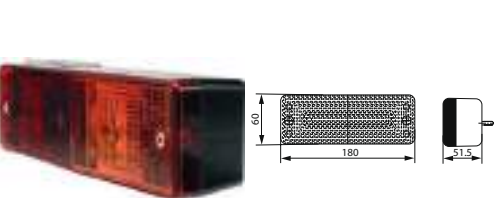

Bulb incl.: No
Watt 1: 10
Watt 2: 21/5

Dim.: 180x60x51.5 mm
Dist. mount. holes:
134 mm

Socket type 1: BA15S
Socket type 2: BAY15d
Material: Shockproof plastic
Shape: Rectangular
Fixing screw: 2
Flasher light: w/
Numberplate light: w/
Tail light: w/
Stop light: w/
RH/LH: RH/LH
E-approval: Yes

171013 Multi Function Lamp

Lens: HC-CARGO 171015. Right: HC-CARGO 171014.

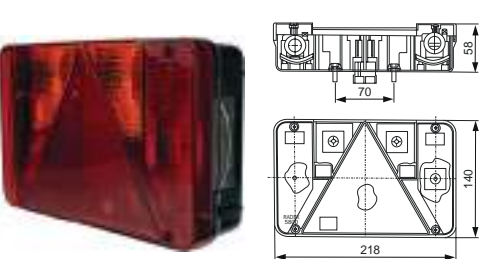

Bulb incl.: No
Watt: 21
Watt 2: 21/5

Dim.: 218x140x58 mm
Dist. mount. holes:
70 mm

Socket type: BA15S
Socket type 2: BAY15d
Material: Shockproof plastic
Shape: Rectangular
Reflector: w/
Fixing screw: 2
Flasher light: w/
Numberplate light: w/
Tail light: w/
Stop light: w/
RH/LH: LH
E-approval: Yes

171014 Multi Function Lamp

Lens: HC-CARGO 171016. Left: HC-CARGO 171013.

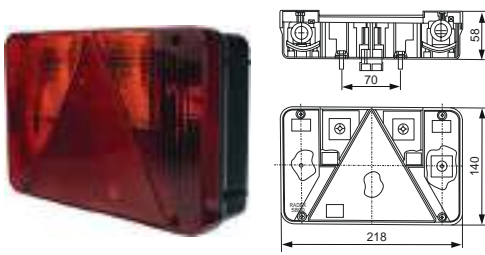

Bulb incl.: No
Watt 1: 21
Watt 2: 21/5

Dim.: 218x140x58 mm
Dist. mount. holes:
70 mm

Socket type 1: BA15S
Socket type 2: BAY15d
Material: Shockproof plastic
Shape: Rectangular
Reflector: w/
Fixing screw: 2
Flasher light: w/
Numberplate light: w/
Tail light: w/
Stop light: w/
RH/LH: RH

171050 Multi Function Lamp

Lens: HC-CARGO 171057. Plug: HC-CARGO 171372, 171373. Right: HC-CARGO 171053.

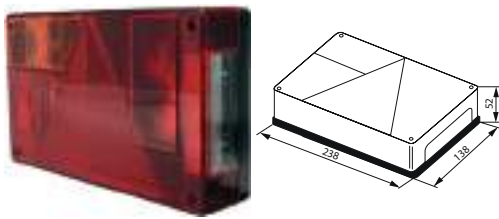

Bulb incl.: No
Watt 1: 21
Watt 2: 21/5
Watt 3: 5

Dim.: 238x138x52 mm
Dist. mount. holes:
152 mm

Socket type 1: BA15S
Socket type 2: BAY15d
Socket type 3: S8.5
Material: Shockproof plastic
Shape: Rectangular
Reflector: w/
Fixing screw: 2
Flasher light: w/
Numberplate light: w/
Rear/fog lamp: w/
Tail light: w/
Stop light: w/
RH/LH: LH
E-approval: Yes

171051 Multi Function Lamp

Lens: HC-CARGO 171056. Plug: HC-CARGO 171372, 171373. Left: HC-CARGO 171054.

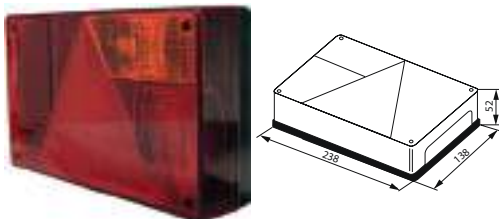

Bulb incl.: No
Watt 1: 21
Watt 2: 21/5
Watt 3: 5

Dim.: 238x138x52 mm
Dist. mount. holes:
152 mm

Socket type 1: BA15S
Socket type 2: BAY15d
Socket type 3: S8.5
Material: Shockproof plastic
Shape: Rectangular
Reflector: w/
Fixing screw: 2
Flasher light: w/
Numberplate light: w/
Tail light: w/
Stop light: w/
RH/LH: RH
E-approval: Yes

171052 Multi Function Lamp

Lens: HC-CARGO 171058. Supplied w/ HC-CARGO 171372, 171373. Left: HC-CARGO 171055.

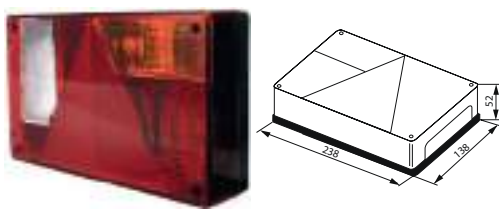

Bulb incl.: No
Watt 1: 21
Watt 2: 21/5
Watt 3: 5

Dim.: 238x138x52 mm
Dist. mount. holes:
152 mm

Socket type 1: BA15S
Socket type 2: BAY15d
Socket type 3: S8.5
Material: Shockproof plastic
Shape: Rectangular
Reflector: w/
Fixing screw: 2
Flasher light: w/
Numberplate light: w/
Reverse light: w/
Tail light: w/
Stop light: w/
RH/LH: RH
E-approval: Yes

171053 Multi Function Lamp

Lens: HC-CARGO 171056. Left: HC-CARGO 171050.

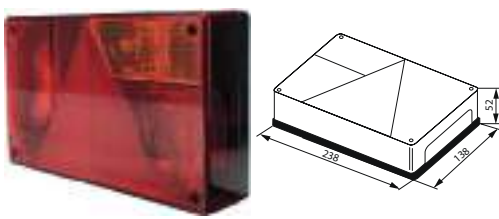

Bulb incl.: No
Watt 1: 21
Watt 2: 21/5
Watt 3: 5

Dim.: 238x138x52 mm
Dist. mount. holes:
152 mm

Socket type 1: BA15S
Socket type 2: BAY15d
Socket type 3: S8.5
Material: Shockproof plastic
Shape: Rectangular
Reflector: w/
Fixing screw: 2
Flasher light: w/
Numberplate light: w/
Rear/fog lamp: w/
Tail light: w/
Stop light: w/
RH/LH: RH
E-approval: Yes

171054 Multi Function Lamp

Lens: HC-CARGO 171057. Plug: HC-CARGO 171372, 171373. Right: HC-CARGO 171051.

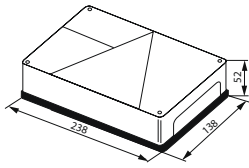

Bulb incl.: No
Watt 1: 21
Watt 2: 21/5
Watt 3: 5

Dim.: 238x138x52 mm
Dist. mount. holes:
152 mm

Socket type 1: BA15S
Socket type 2: BAY15d
Socket type 3: S8.5
Material: Shockproof plastic
Shape: Rectangular
Reflector: w/
Fixing screw: 2
Flasher light: w/
Numberplate light: w/
Tail light: w/
Stop light: w/
RH/LH: LH
E-approval: Yes

171055 Multi Function Lamp

Lens: HC-CARGO 171059. Plug: HC-CARGO 171372, 171373. Right: HC-CARGO 171052.

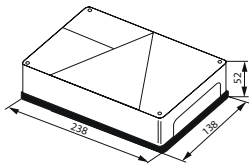

Bulb incl.: No
Watt 1: 21
Watt 2: 21/5
Watt 3: 5

Dim.: 238x138x52 mm
Dist. mount. holes:
152 mm

Socket type 1: BA15S
Socket type 2: BAY15d
Socket type 3: S8.5
Material: Shockproof plastic
Shape: Rectangular
Reflector: w/
Fixing screw: 2
Flasher light: w/
Numberplate light: w/
Reverse light: w/
Tail light: w/
Stop light: w/
RH/LH: LH
E-approval: Yes

171191 Multi Function Lamp

Lens: HC-CARGO 171236.

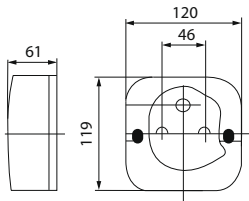

Bulb incl.: No
Watt 1: 21
Watt 2: 10

Dim.: 120x119x61 mm
Dist. mount. holes:
46 mm

Socket type 1: BA15S
Socket type 2: BA15S
Material: Shockproof plastic
Fixing screw: 2
Flasher light: w/
Numberplate light: w/
Tail light: w/
Stop light: w/
RH/LH: RH/LH
E-approval: Yes

171192 Multi Function Lamp

Mounting kit: HC-CARGO 171266. Lens: HC-CARGO 171237.

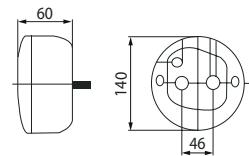

Bulb incl.: No
Watt 1: 21
Watt 2: 5

Dim.: 140x60 mm
OD: 140 mm
Dist. mount. holes:
46 mm

Socket type 1: BA15S
Socket type 2: BA15S
Material: Shockproof plastic
Shape: Round
Fixing screw: 2
Flasher light: w/
Numberplate light: w/
Tail light: w/
Stop light: w/
E-approval: Yes

171193 Multi Function Lamp

Mounting kit: HC-CARGO 171266. Lens: HC-CARGO 171237.

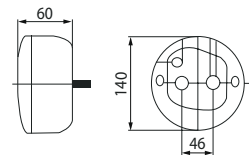

Bulb incl.: No
Watt 1: 21
Watt 2: 5

Dim.: 140x60 mm
OD: 140 mm
Dist. mount. holes:
46 mm

Socket type 1: BA15S
Socket type 2: BA15S
Material: Shockproof plastic
Shape: Round
Fixing screw: 2
Flasher light: w/
Tail light: w/
Stop light: w/
E-approval: Yes

171194 Multi Function Lamp

Mounting kit: HC-CARGO 171266. Lens: HC-CARGO 171237.

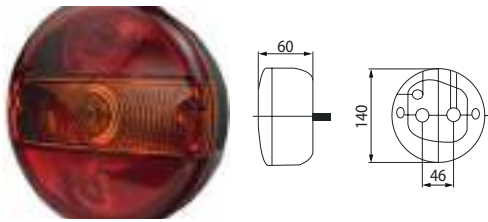

 Bulb incl.: No
 Watt 1: 21
 Watt 2: 5

 Dim.: 140x60 mm
 OD: 140 mm
 Dist. mount. holes:
 45 mm

 Socket type 1: BA15S
 Socket type 2: BA15S
 Material: Shockproof plastic
 Shape: Round
 Fixing screw: 2
 Flasher light: w/
 Numberplate light: w/
 Tail light: w/
 Stop light: w/
 E-approval: Yes

171195 Multi Function Lamp

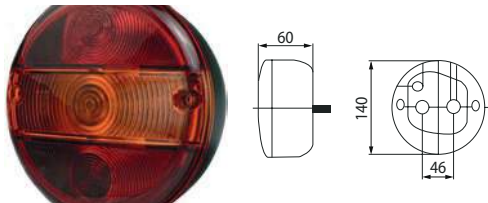
Mounting kit: HC-CARGO 171266. Lens: HC-CARGO 171237.



 Bulb incl.: No
 Watt 1: 21
 Watt 2: 5

 Dim.: 140x60 mm
 OD: 140 mm
 Dist. mount. holes:
 46 mm

 Socket type 1: BA15S
 Socket type 2: BA15S
 Material: Shockproof plastic
 Shape: Round
 Fixing screw: 2
 Flasher light: w/
 Tail light: w/
 Stop light: w/
 E-approval: Yes

171202 Multi Function Lamp

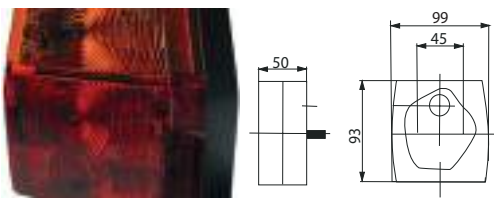
Lens: HC-CARGO 171253.



 Bulb incl.: No
 Watt 1: 21
 Watt 2: 5

 Dim.: 93x99x50 mm
 Dist. mount. holes:
 45 mm

 Socket type 1: BA15S
 Socket type 2: S8.5
 Material: Shockproof plastic
 Shape: Hexagon
 Fixing screw: 2
 Flasher light: w/
 Tail light: w/
 Stop light: w/
 E-approval: Yes

171203 Multi Function Lamp

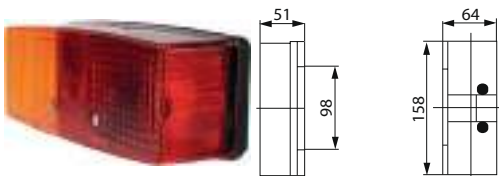
Lens: HC-CARGO 171258. Right: HC-CARGO 171204.



 Bulb incl.: No
 Watt 1: 21/5
 Watt 2: 10

 Dim.: 158x64x51 mm
 Dist. mount. holes:
 98/45 mm

 Socket type 1: BAY15d
 Socket type 2: BA15S
 Material: Shockproof plastic
 Shape: Rectangular
 Reflector: w/
 Fixing screw: 4
 Flasher light: w/
 Numberplate light: w/
 Tail light: w/
 Stop light: w/
 RH/LH: LH
 E-approval: Yes

171204 Multi Function Lamp

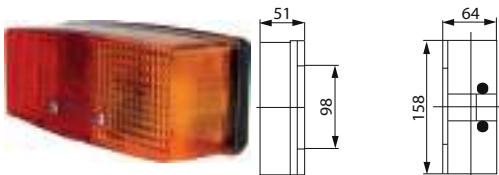
Lens: HC-CARGO 171259. Left: HC-CARGO 171203.



 Bulb incl.: No
 Watt 1: 10
 Watt 2: 21/5

 Dim.: 158x64x51 mm
 Dist. mount. holes:
 98/45 mm

 Socket type 1: BA15S
 Socket type 2: BAY15d
 Material/dome: Shockproof plastic
 Shape: Rectangular
 Reflector: w/
 Fixing screw: 4
 Flasher light: w/
 Numberplate light: w/
 Tail light: w/
 Stop light: w/
 RH/LH: RH

171213 Multi Function Lamp

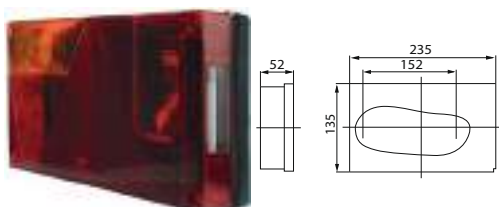
Lens: HC-CARGO 171264. Right: HC-CARGO 171214.



 Bulb incl.: No
 Watt 1: 21
 Watt 2: 21-maj
 Watt 3: 5

 Dim.: 235x135x52 mm
 Dist. mount. holes:
 152 mm

 Socket type 1: BA15S
 Socket type 2: BAY15d
 Socket type 3: S8.5
 Material: Shockproof plastic
 Shape: Rectangular
 Reflector: w/
 Fixing screw: 2
 Flasher light: w/
 Numberplate light: w/
 Tail light: w/
 Stop light: w/
 RH/LH: LH
 E-approval: Yes

171214 Multi Function Lamp

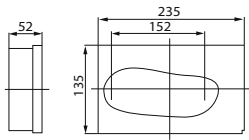
Lens: HC-CARGO 171265. Left: HC-CARGO 171213.



Bulb incl.: No
Watt 1: 21
Watt 2: 21/5
Watt 3: 5

Dim.: 235x135x52 mm
Dist. mount. holes: 152 mm

Socket type 1: BA15S
Socket type 2: BAY15d
Socket type 3: S8.5
Material: Shockproof plastic
Shape: Rectangular
Reflector: w/
Fixing screw: 2
Flasher light: w/
Numberplate light: w/
Tail light: w/
Stop light: w/
RH/LH: RH
E-approval: Yes

171328 Multi Function Lamp

Lens: HC-CARGO 171330.

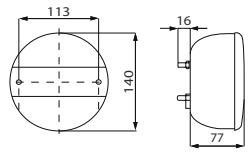

Bulb incl.: No
Watt 1: 21
Watt 2: 5

Dim.: 140x77 mm
OD: 140 mm
Dist. mount. holes: 45 mm

Socket type 1: BA15S
Socket type 2: BA15S
Material: Shockproof plastic
Shape: Circular
Fixing screw: 2
Flasher light: w/
Numberplate light: w/
Tail light: w/
Stop light: w/
E-approval: Yes

171329 Multi Function Lamp

Mounting kit: HC-CARGO 171266. Lens: HC-CARGO 171330.

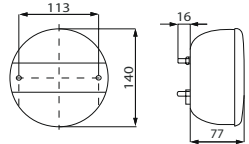

Bulb incl.: No

Dim.: 140x77 mm
OD: 140 mm
Dist. mount. holes: 45 mm

Socket type 1: BA15S
Material: Shockproof plastic
Shape: Circular
Fixing screw: 2
Flasher light: w/
Tail light: w/
Stop light: w/
E-approval: Yes

171533 Multi Function Lamp

Lens: HC-CARGO 171015. Plug: HC-CARGO 171537, 171538. Right: HC-CARGO 171534.

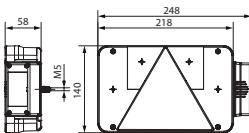

Bulb incl.: No
Watt 1: 21
Watt 2: 21/5
Watt 3: 5

Dim.: 248x140x58 mm
Dist. mount. holes: 70 mm

Socket type 1: BA15S
Socket type 2: BAY15d
Socket type 3: S8.5
Material: Shockproof plastic
Shape: Rectangular
Reflector: w/
Fixing screw: 2
Flasher light: w/
Numberplate light: w/
Tail light: w/
Stop light: w/
RH/LH: LH

171534 Multi Function Lamp

Lens: HC-CARGO 171016. Plug: HC-CARGO 171537, 171538. Left: HC-CARGO 171533.

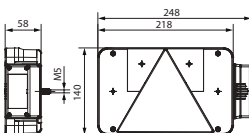

Bulb incl.: No
Watt 1: 21
Watt 2: 21/5
Watt 3: 5

Dim.: 248x140x58 mm
Dist. mount. holes: 70 mm

Socket type 1: BA15S
Socket type 2: BAY15d
Socket type 3: S8.5
Material: Shockproof plastic
Shape: Rectangular
Reflector: w/
Fixing screw: 2
Flasher light: w/
Numberplate light: w/
Tail light: w/
Stop light: w/
RH/LH: RH

171822 Multi Function Lamp

Servicing: HC-CARGO 171821

Multi connector: HC-CARGO 171372, 171373. Lens: HC-CARGO 170833.

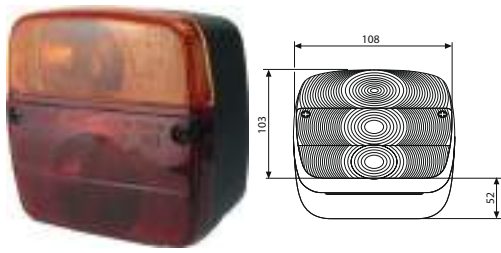

Bulb incl.: Yes
Watt 1: 21
Watt 2: 21/5

Dim.: 108x103x52 mm
Dist. mount. holes:
45/55 mm

Socket type 1: BA15S
Socket type 2: BAY15d
Shape: Square
Flasher light: w/
Sidemarker: w/
Stop light: w/
E-approval: Yes

171917 Multi Function Lamp

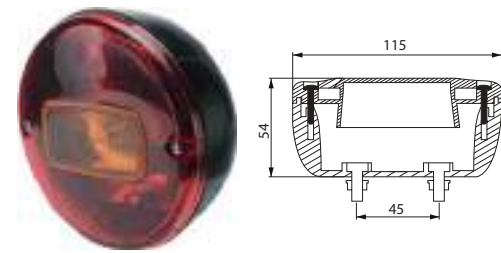

Bulb incl.: No
Watt 1: 5
Watt 2: 18
Watt 3: 18

Dim.: 115x54 mm
OD: 115 mm
Dist. mount. holes:
45 mm

Bulb type 1: 10.5x36 mm
Bulb type 2: 15x41 mm
Bulb type 3: 15x41 mm
Socket type: S8.5
Socket type 2: S8.5
Socket type 3: S8.5
Colour/glass: Red/yellow
Material/dome: PMMA
Shape: Round
Fixing screw: 2
Flasher light: w/
Tail light: w/
Stop light: w/
RH/LH: RH/LH

172021 Multi Function Lamp

Lens: HC-CARGO 172023. Right: HC-CARGO 172022.

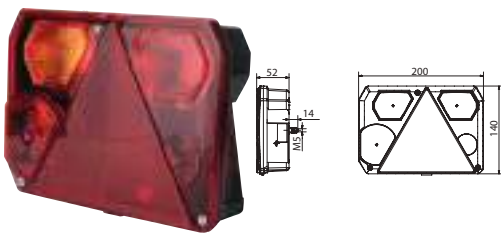

Bulb incl.: No
Watt 1: 21
Watt 2: 21/5
Watt 3: 5

Dim.: 200x140x52 mm
Dist. mount. holes:
152 mm

Socket type 1: BA15S
Socket type 2: BAY15d
Socket type 3: S8.5
Material: Shockproof plastic
Reflector: w/
Fixing screw: 2
Flasher light: w/
Numberplate light: w/
Rear/fog lamp: w/
Tail light: w/
Stop light: w/
RH/LH: LH
E-approval: Yes

172022 Multi Function Lamp

Lens: HC-CARGO 172024. Left: HC-CARGO 172021.

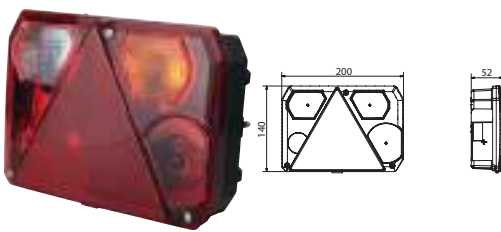

Bulb incl.: No
Watt 1: 21
Watt 2: 21/5
Watt 3: 5

Dim.: 200x140x52 mm
Dist. mount. holes:
152 mm

Socket type 1: BA15S
Socket type 2: BAY15d
Socket type 3: S8.5
Material: Shockproof plastic
Reflector: w/
Fixing screw: 2
Flasher light: w/
Numberplate light: w/
Reverse light: w/
Tail light: w/
Stop light: w/
RH/LH: RH
E-approval: Yes

172025 Multi Function Lamp

Lens: HC-CARGO 172023. Right: HC-CARGO 172026. Plug: HC-CARGO 171537, 171538.

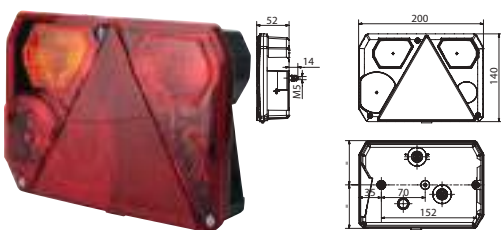

Bulb incl.: Yes
Voltage: 12
Watt 1: 21
Watt 2: 21/5
Watt 3: 5

Dim.: 200x140x52 mm
Dist. mount. holes:
152 mm

Socket type 1: BA15S
Socket type 2: BAY15d
Socket type 3: S8.5
Material: Shockproof plastic
Reflector: w/
Fixing screw: 2
Flasher light: w/
Numberplate light: w/
Rear/fog lamp: w/
Tail light: w/
Stop light: w/
RH/LH: LH
E-approval: Yes

172026 Multi Function Lamp

Lens: HC-CARGO 172024. Left: HC-CARGO 172025. Plug: HC-CARGO 171537, 171538.

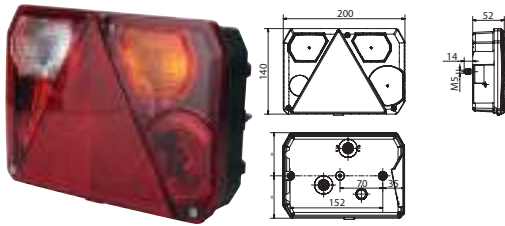

Bulb incl.: Yes
Voltage: 12
Watt 1: 21
Watt 2: 21/5
Watt 3: 5

Dim.: 200x140x52 mm
Dist. mount. holes: 152 mm

Socket type 1: BA15S
Socket type 2: BAY15d
Socket type 3: S8.5
Material: Shockproof plastic
Reflector: w/
Fixing screw: 2
Flasher light: w/
Numberplate light: w/
Reverse light: w/
Tail light: w/
Stop light: w/
RH/LH: RH
E-approval: Yes

172047 Multi Function Lamp

Lens: HC-CARGO 172051. Right: HC-CARGO 172048. Plug: HC-CARGO 171537, 171538.

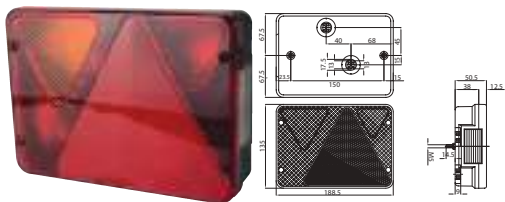

Bulb incl.: Yes
Voltage: 12
Watt 1: 21
Watt 2: 21/5
Watt 3: 5

Dim.: 188.5x135x50.5 mm
Dist. mount. holes: 150 mm

Socket type 1: BA15S
Socket type 2: BAY15d
Socket type 3: S8.5
Colour: Black
Material: Polypropylene
Material/dome: PMMA
Reflector: w/
Fixing screw: 2
Flasher light: w/
Numberplate light: w/
Rear/fog lamp: w/
Tail light: w/
Stop light: w/
RH/LH: LH
Approvals: CE
E-approval: Yes

172048 Multi Function Lamp

Lens: HC-CARGO 172052. Left: HC-CARGO 172047. Plug: HC-CARGO 171537, 171538.

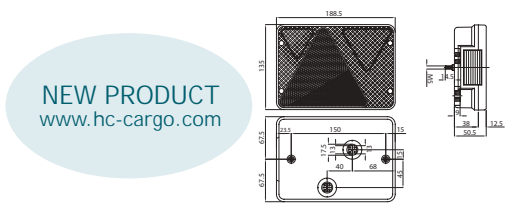

NEW PRODUCT
www.hc-cargo.com

Bulb incl.: Yes
Voltage: 12
Watt 1: 21
Watt 2: 21/5
Watt 3: 5

Dim.: 188.5x135x50.5 mm
Dist. mount. holes: 150 mm

Socket type 1: BA15S
Socket type 2: BAY15d
Socket type 3: S8.5
Colour: Black
Material: Polypropylene
Material/dome: PMMA
Reflector: w/
Fixing screw: 2
Flasher light: w/
Numberplate light: w/
Rear/fog lamp: w/
Tail light: w/
Stop light: w/
RH/LH: RH
Approvals: CE
E-approval: Yes

172049 Multi Function Lamp

Servicing: UK

Lens: HC-CARGO 172057. Left: HC-CARGO 172050. Plug: HC-CARGO 171537, 171538.

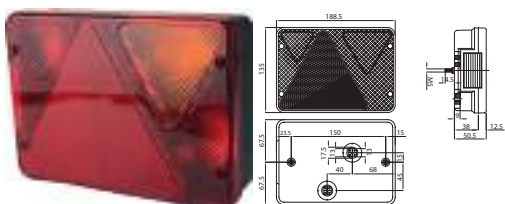

Bulb incl.: Yes
Voltage: 12
Watt 1: 21
Watt 2: 21/5
Watt 3: 5

Dim.: 188.5x135x50.5 mm
Dist. mount. holes: 150 mm

Socket type 1: BA15S
Socket type 2: BAY15d
Socket type 3: S8.5
Colour: Black
Material: Polypropylene
Material/dome: PMMA
Reflector: w/
Fixing screw: 2
Flasher light: w/
Numberplate light: w/
Rear/fog lamp: w/
Tail light: w/
Stop light: w/
RH/LH: RH
Approvals: CE
E-approval: Yes

172050 Multi Function Lamp

Servicing: UK

Lens: HC-CARGO 172058. Right: HC-CARGO 172049. Plug: HC-CARGO 171537, 171538.

NEW PRODUCT
www.hc-cargo.com

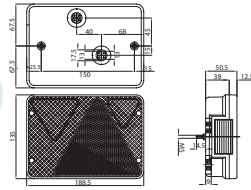

Bulb incl.: Yes
Voltage: 12
Watt 1: 21
Watt 2: 21/5
Watt 3: 5

Dim.: 188.5x135x50.5 mm
Dist. mount. holes: 150 mm

Socket type 1: BA15S
Socket type 2: BAY15d
Socket type 3: S8.5
Colour: Black
Material: Polypropylene
Material/dome: PMMA
Reflector: w/
Fixing screw: 2
Flasher light: w/
Numberplate light: w/
Rear/fog lamp: w/
Tail light: w/
Stop light: w/
RH/LH: LH
Approvals: CE
E-approval: Yes

172068 Multi Function Lamp

Lens: HC-CARGO 172070. Right: HC-CARGO 172069. Plug: HC-CARGO 171537, 171538

NEW PRODUCT
www.hc-cargo.com

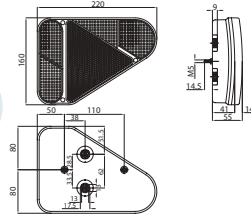

Bulb incl.: Yes
Voltage: 12
Watt 1: 21/5
Watt 2: 21

Dim.: 220x160x55 mm
Dist. mount. holes: 110 mm

Socket type 1: BAY15d
Socket type 2: BA15S
Colour: Black
Material: Polypropylene
Material/dome: Polycarbonate
Shape: Triangle
Reflector: w/
Fixing screw: 2
Flasher light: w/
Rear/fog lamp: w/
Sidemarker: w/
Stop light: w/
RH/LH: LH
E-approval: Yes

172069 Multi Function Lamp

Lens: HC-CARGO 172071. Right: HC-CARGO 172068. Plug: HC-CARGO 171537, 171538

NEW PRODUCT
www.hc-cargo.com

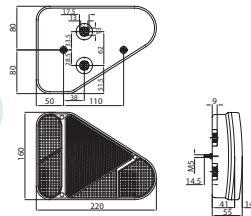

Bulb incl.: Yes
Voltage: 12
Watt 1: 21/5
Watt 2: 21

Dim.: 220x160x55 mm
Dist. mount. holes: 110 mm

Socket type 1: BAY15d
Socket type 2: BA15S
Colour: Black
Material: Polypropylene
Material/dome: Polycarbonate
Shape: Triangle
Reflector: w/
Fixing screw: 2
Flasher light: w/
Rear/fog lamp: w/
Sidemarker: w/
Stop light: w/
RH/LH: RH
E-approval: Yes

SPARE PARTS

170687 Lens, Rear Lamp

Servicing: HC-CARGO 170685



Dim.: 104x98 mm

RH/LH: RH/LH







170833 Lens, Rear Lamp







Servicing: HC-CARGO 170939, 170940





Dim.: 108x103x52 mm



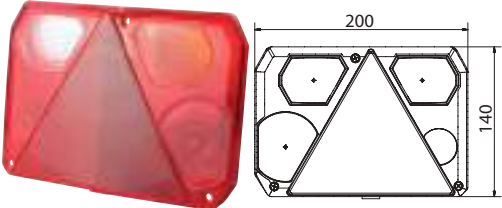
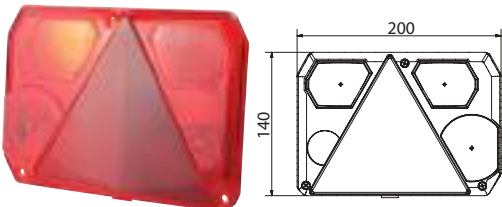

Material: Shockproof plastic
Flasher light: w/
Tail light: w/
Stop light: w/
RH/LH: RH/LH

EL. SPECIFICATIONS	DIMENSIONS	ADDITIONAL SPECIFICATIONS
170847 Lens, Rear Lamp 	Servicing: HC-CARGO 170846 Dim.: 111x82 mm	Material: Shockproof plastic RH/LH: RH/LH
170944 Lens, Rear Lamp 	Servicing: HC-CARGO 170943 Dim.: 120x80 mm	Material: Shockproof plastic Shape: Rectangular RH/LH: RH/LH
171015 Lens, Rear Lamp 	Servicing: HC-CARGO 171013, 171533 Dim.: 218x140 mm	Material: Shockproof plastic Shape: Rectangular Reflector: w/ RH/LH: LH
171016 Lens, Rear Lamp 	Servicing: HC-CARGO 171534, 171014 Dim.: 218x140 mm	Material: Shockproof plastic Shape: Rectangular Reflector: w/ RH/LH: RH
171056 Lens, Rear Lamp 	Servicing: HC-CARGO 171051, 171053 Dim.: 235x135x52 mm	Material: Shockproof plastic Shape: Rectangular Reflector: w/ Numberplate light: w/ RH/LH: RH
171057 Lens, Rear Lamp 	Servicing: HC-CARGO 171050, 171054 Dim.: 235x135x52 mm	Material: Shockproof plastic Shape: Rectangular Reflector: w/ Numberplate light: w/ RH/LH: LH
171058 Lens, Rear Lamp 	Servicing: HC-CARGO 171052 Dim.: 235x135 mm	Material: Shockproof plastic Shape: Rectangular Reflector: w/ Numberplate light: w/ RH/LH: RH

EL. SPECIFICATIONS	DIMENSIONS	ADDITIONAL SPECIFICATIONS
171059 Lens, Rear Lamp 	Servicing: HC-CARGO 171055 Dim.: 235x135 mm	Material: Shockproof plastic Shape: Rectangular Reflector: w/ Numberplate light: w/ RH/LH: LH
171162 Lens, Rear Lamp 	Servicing: Ford Transit 1986 Dim.: 364x94 mm	Material: Shockproof plastic Shape: Rectangular Reflector: w/ E-approval: Yes
171236 Lens, Rear Lamp 	Servicing: HC-CARGO 171191 Dim.: 122.5x122.5x53 mm	Shape: Square RH/LH: RH/LH
171237 Lens, Rear Lamp 	Servicing: HC-CARGO 171192, 171193, 171194, 171195 OD: 140 mm	Type: Tail lamp Material: Plastic Shape: Circular RH/LH: RH/LH
171253 Lens, Rear Lamp 	Servicing: HC-CARGO 171202 Dim.: 93x99 mm	Material: Shockproof plastic Shape: Hexagon RH/LH: RH/LH
171258 Lens, Rear Lamp 	Servicing: HC-CARGO 171203 Dim.: 158x64 mm	Material: Shockproof plastic Shape: Rectangular Reflector: w/ RH/LH: LH
171259 Lens, Rear Lamp 	Servicing: HC-CARGO 171204 Dim.: 158x64 mm	Shape: Rectangular Reflector: w/ RH/LH: RH

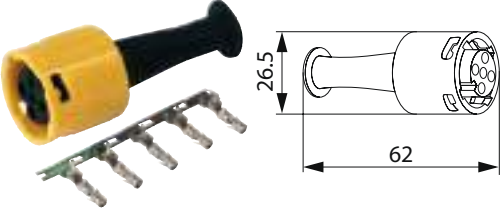
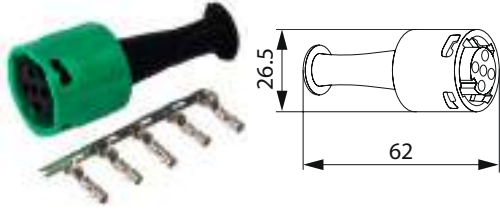
EL. SPECIFICATIONS	DIMENSIONS	ADDITIONAL SPECIFICATIONS
171264 Lens, Rear Lamp 	Servicing: HC-CARGO 171213 Dim.: 235x135 mm	Shape: Rectangular Reflector: w/ Numberplate light: w/ RH/LH: LH
171265 Lens, Rear Lamp 	Servicing: HC-CARGO 171214 Dim.: 235x135 mm	Shape: Rectangular Reflector: w/ Numberplate light: w/ RH/LH: RH
171330 Lens, Rear Lamp 	Servicing: HC-CARGO 171328, 171329 OD: 140 mm	Material: Plastic Shape: Circular RH/LH: RH/LH
172023 Lens, Rear Lamp 	Servicing: HC-CARGO: 172021 Dim.: 200x140 mm	Reflector: w/ RH/LH: LH
172024 Lens, Rear Lamp 	Servicing: HC-CARGO: 172022 Dim.: 200x140 mm	Reflector: w/ Reverse light: w/ RH/LH: RH
172051 Lens, Rear Lamp <div style="border: 1px solid black; border-radius: 50%; padding: 20px; text-align: center;"> <p>NEW PRODUCT</p> <p>www.hc-cargo.com</p> </div>	Servicing: HC-CARGO 172047 Dim.: 188.5x135 mm	Material/dome: PMMA
172052 Lens, Rear Lamp <div style="border: 1px solid black; border-radius: 50%; padding: 20px; text-align: center;"> <p>NEW PRODUCT</p> <p>www.hc-cargo.com</p> </div>	Servicing: HC-CARGO 172048 Dim.: 188.5x135 mm	Material: PMMA

EL. SPECIFICATIONS	DIMENSIONS	ADDITIONAL SPECIFICATIONS
172057 Lens, Rear Lamp Servicing: HC-CARGO 172049		
<p style="text-align: center; font-size: 24px; color: #0070C0;">NEW PRODUCT</p> <p style="text-align: center; color: #0070C0;">www.hc-cargo.com</p>	<p>Dim.: 188.5x135 mm</p>	<p>Material/dome: PMMA</p>
172058 Lens, Rear Lamp Servicing: HC-CARGO 172050		
<p style="text-align: center; font-size: 24px; color: #0070C0;">NEW PRODUCT</p> <p style="text-align: center; color: #0070C0;">www.hc-cargo.com</p>	<p>Dim.: 188.5x135 mm</p>	<p>Material/dome: PMMA</p>
172070 Lens, Rear Lamp Servicing: HC-CARGO 172068		
<p style="text-align: center; font-size: 24px; color: #0070C0;">NEW PRODUCT</p> <p style="text-align: center; color: #0070C0;">www.hc-cargo.com</p>	<p>Dim.: 220x160 mm</p>	<p>Material/dome: Polycarbonate Shape: Triangle RH/LH: LH</p>
172071 Lens, Rear Lamp Servicing: HC-CARGO 172069		
<p style="text-align: center; font-size: 24px; color: #0070C0;">NEW PRODUCT</p> <p style="text-align: center; color: #0070C0;">www.hc-cargo.com</p>	<p>Dim.: 220x160 mm</p>	<p>Material/dome: Polycarbonate Shape: Triangle RH/LH: RH</p>
<h3>ACCESSORIES</h3>		
170604 Vibration Damper Servicing: HC-CARGO 170602, 171323		
<i>Gives a longer life to the bulbs.</i>		
171266 Repair Kit Servicing: HC-CARGO 171193, 171195, 171329, 171549, 171550		
<i>Circulars.</i>		

<p>171372 Multi Connector</p> <p>Socket w/ quick connection.</p> 		<p>Dim.: 62x26.5 mm</p>	<p>Colour/glass: Yellow RH/LH: LH E-approval: Yes</p>
<p>171373 Multi Connector</p> <p>Socket w/ quick connection.</p> 		<p>Dim.: 62x26.5 mm</p>	<p>Colour/glass: Green RH/LH: RH E-approval: Yes</p>
<p>171537 Multi Connector</p> <p>Socket w/ quick connection.</p> 			<p>Colour: Red RH/LH: LH</p>
<p>171538 Multi Connector</p> <p>Socket w/ quick connection.</p> 			<p>Colour: Green RH/LH: RH</p>
<p>171788 Multiconnector 7 pin</p> <p>Gasket: HC-CARGO 192178. Terminal: HC-CARGO 193250.</p> 			<p>Type/terminal: Round Colour: Black No./poles: 7 Plug: Female</p>
<p>172015 Cable w/ plug</p> <p>Cover of click-in connector HC-CARGO 172016.</p> 			<p>Type: Clip-on, Round</p>

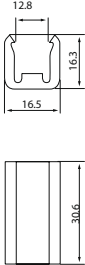
172016 Cover of click-in connector  		Servicing: HC-CARGO 171730, 171731, 171732, 171733, 171734, 172015	
		ID: 12.8 mm Total length: 30.6 mm Height: 16.3 mm Width: 16.5 mm	

172066 Multiconnector 7 pin 		Servicing: HC-CARGO 171506, 171756, 171757, 171802, 171803, 171927, 171928, 171929, 171930, 172061, 172062, 172063, 172064	
		Type/terminal: Round Colour: Black No./poles: 7 Plug: Female	

181627 Bayonet connector 		Servicing: HC-CARGO 181617	
		Voltage: 12	
		Mount.: Terminal No./poles: 8	

TRAILER LAMPS LED

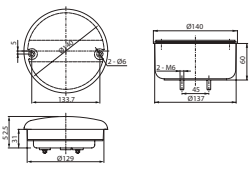
171549 LED Multifunction Lamp Mounting kit: HC-CARGO 171266.  		Voltage: 9-33	
		Dim.: 140x60 mm Dist. mount. holes: 45 mm	
		Type: LED Colour: Black Material: Shockproof plastic Shape: Circular Fixing screw: 2 Flasher light: w/ Tail light: w/ Stop light: w/ No./LEDs: 63 E-approval: Yes	

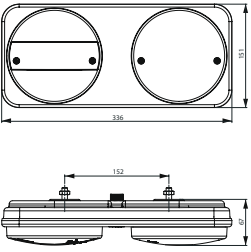
171665 LED Multifunction Lamp Right: HC-CARGO 171666.  		Voltage: 12/24	
		Dim.: 336x151x67 mm Dist. mount. holes: 152 mm	
		Type: LED Material: Shockproof plastic Shape: Rectangular Reflector: w/ Flasher light: w/ Reverse light: w/ Tail light: w/ Stop light: w/ RH/LH: LH E-approval: Yes	

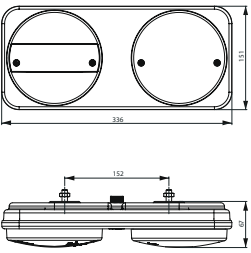
171666 LED Multifunction Lamp Left: HC-CARGO 171665.  		Voltage: 12/24	
		Dim.: 336x151x67 mm Dist. mount. holes: 152 mm	
		Type: LED Material: Shockproof plastic Shape: Rectangular Reflector: w/ Flasher light: w/ Reverse light: w/ Tail light: w/ Stop light: w/ RH/LH: RH E-approval: Yes	

171667 LED Multifunction Lamp

White = ground. Brown = tail light. Red = stop. Yellow = indicator.

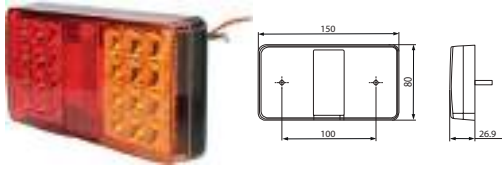

Voltage: 12/24

Dim.: 150x80x26.9 mm
Dist. mount. holes:
100 mm

Type: LED
Material: Plastic
Shape: Rectangular
Reflector: w/
Flasher light: w/
Tail light: w/
Stop light: w/
No./LEDs: 24
Tightness norm: IP 67
E-approval: Yes

171668 LED Multifunction Lamp

White = ground. Brown = tail light. Red = stop. Yellow = indicator.

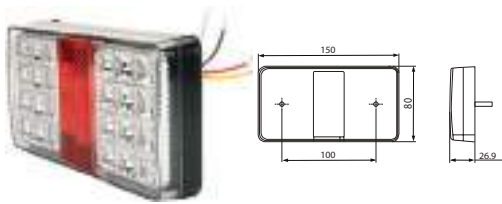

Voltage: 12/24

Dim.: 150x80x26.9 mm
Dist. mount. holes:
100 mm

Type: LED
Colour/glass: Transparent
Material: Shockproof plastic
Material/dome: Glass
Shape: Rectangular
Reflector: w/
Flasher light: w/
Tail light: w/
Stop light: w/
No./LEDs: 24
Tightness norm: IP 67
E-approval: Yes

171725 LED Multifunction Lamp

Ring: amber, center: red.

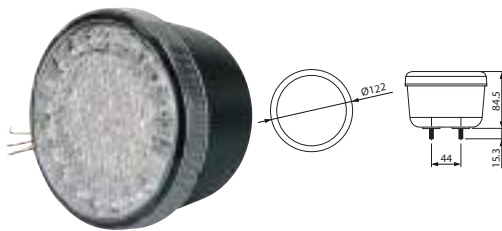

Voltage: 12/24

Dim.: 122x84.5 mm
OD: 122 mm
Cable length: 150 mm
Dist. mount. holes:
44 mm

Type: LED
Material: Shockproof plastic
Material/dome: Shockproof plastic
Shape: Round
Fixing screw: 6
Flasher light: w/
Tail light: w/
Stop light: w/
No./LEDs: 44
E-approval: Yes

171726 LED Fog/Reverse Lamp

Ring: clear, center: red.

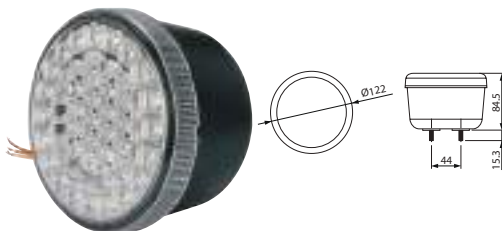

Voltage: 12/24

Dim.: 122x84.5 mm
OD: 122 mm
Cable length: 150 mm
Dist. mount. holes:
44 mm

Type: LED
Material: Shockproof plastic
Material/dome: Shockproof plastic
Rear/fog lamp: w/
Reverse light: w/
No./LEDs: 38
E-approval: Yes

171756 LED Multifunction Lamp

Multi-plug: HC-CARGO 171788, 172066.

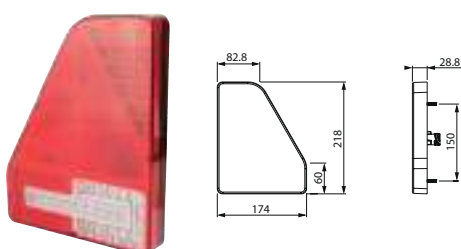

Voltage: 12/24

Dim.: 174x218x28.8 mm
Dist. mount. holes:
150 mm

Type: Tail/position lamp
Material: Shockproof plastic
Material/dome: Shockproof plastic
Shape: Triangle
Reflector: w/
Flasher light: w/
Rear/fog lamp: w/
Reverse light: w/
Tail light: w/
Stop light: w/
RH/LH: RH
Tightness norm: IP 67
Approvals: CE
E-approval: Yes

171757 LED Multifunction Lamp

Multi-plug: HC-CARGO 171788, 172066.

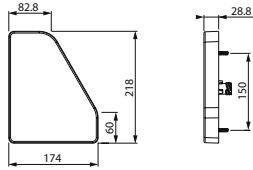

Voltage: 12/24

Dim.: 174x218x28.8 mm
Dist. mount. holes:
150 mm

Type: Tail/position lamp
Material: Shockproof plastic
Material/dome: Shockproof plastic
Shape: Triangle
Reflector: w/
Flasher light: w/
Rear/fog lamp: w/
Reverse light: w/
Tail light: w/
Stop light: w/
RH/LH: LH
Tightness norm: IP 67
Approvals: CE
E-approval: Yes

171758 LED Multifunction Lamp

White = ground. Red = stop. Black = tail. Yellow = indicator. Brown = reverse.

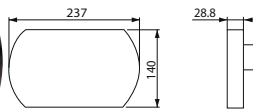

Voltage: 12/24

Dim.: 237x140x28.8 mm
Cable length: 2000 mm
Dist. mount. holes:
152 mm

Type: Tail lamp
Material: Shockproof plastic
Material/dome: Shockproof plastic
Shape: Oval
Mount.: 2 screws
Reflector: w/
Flasher light: w/
Numberplate light: w/
Reverse light: w/
Tail light: w/
Stop light: w/
RH/LH: RH
Tightness norm: IP 66
E-approval: Yes

171759 LED Multifunction Lamp

White = ground. Red = stop. Black = tail. Yellow = indicator. Blue = fog.

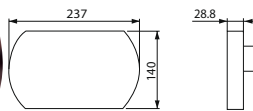

Voltage: 12/24

Dim.: 237x140x28.8 mm
Cable length: 2000 mm
Dist. mount. holes:
152 mm

Type: Tail lamp
Material: Shockproof plastic
Material/dome: Shockproof plastic
Shape: Oval
Mount.: 2 screws
Reflector: w/
Flasher light: w/
Numberplate light: w/
Rear/fog lamp: w/
Tail light: w/
Stop light: w/
RH/LH: LH
Tightness norm: IP 66
E-approval: Yes

171772 LED Multifunction Lamp

White=ground. Brown=tail. Yellow=flasher. Red=stop.

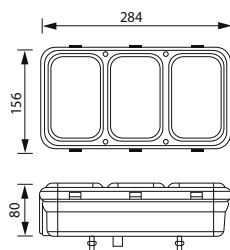

Voltage: 24

Dim.: 284x156x102 mm
Dist. mount. holes:
130x78 mm

Type: Tail lamp
Material: Polypropylene
Material/dome: PMMA
Shape: Rectangular
Mount.: 4 screws
Reflector: w/
Flasher light: w/
Tail light: w/
Stop light: w/
No./LEDs: 3x16
RH/LH: RH/LH
E-approval: Yes

171789 LED Multifunction Lamp

Vertical mount.

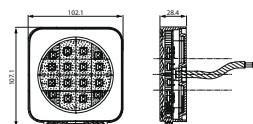

Voltage: 12/24

Dim.:
102.1x107.1x28.4 mm
Cable length: 500 mm
Dist. mount. holes:
45 mm

Type: Tail lamp
Bulb type: LED
Material: Polycarbonate
Material/dome: Polycarbonate
Shape: Square
Mount.: 2 screws
Reflector: w/
Flasher light: w/
Numberplate light: w/
Tail light: w/
Stop light: w/
No./LEDs: 12
RH/LH: RH/LH
Tightness norm: IP 67
E-approval: Yes

171790 LED Multifunction Lamp

Vertical mount.

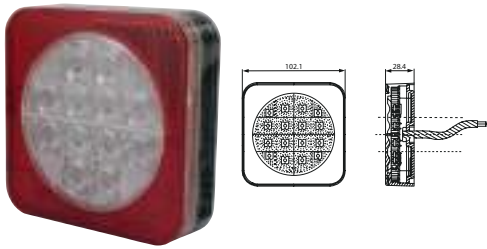

Voltage: 12/24

Dim.: 102.1x28.4 mm
Cable length: 500 mm
Dist. mount. holes:
45 mm

Type: Tail lamp
Material: Polycarbonate
Material/dome: Polycarbonate
Shape: Square
Mount.: 2 screws
Reflector: w/
Flasher light: w/
Tail light: w/
Stop light: w/
No./LEDs: 12
RH/LH: RH/LH
Tightness norm: IP 67
E-approval: Yes

171791 LED Multifunction Lamp

Horizontal mount.

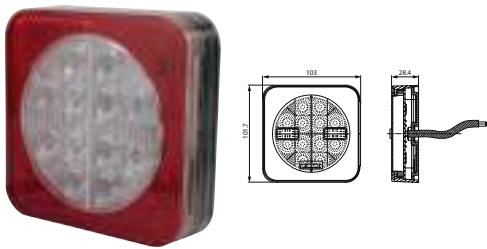

Voltage: 12/24

Dim.: 103x101.7x28.4 mm
Cable length: 500 mm
Dist. mount. holes:
45 mm

Type: Tail lamp
Material: Polycarbonate
Material/dome: Polycarbonate
Shape: Square
Mount.: 2 screws
Reflector: w/
Flasher light: w/
Numberplate light: w/
Tail light: w/
Stop light: w/
No./LEDs: 12
RH/LH: RH/LH
Tightness norm: IP 67
E-approval: Yes

171927 LED Multifunction Lamp

Left: HC-CARGO 171928. Multi-plug: HC-CARGO 171788, 172066.

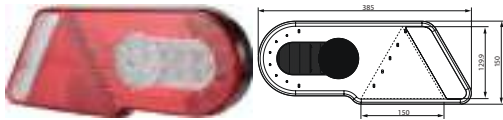

Voltage: 12-24

Dim.: 385x150x34.1 mm
Dist. mount. holes:
152.3 mm

Type: LED
Shape: Rectangular
Reflector: w/
Flasher light: w/
Rear/fog lamp: w/
Reverse light: w/
Tail light: w/
Stop light: w/
RH/LH: RH
Tightness norm: IP 67
Approvals: CE
E-approval: Yes

171928 LED Multifunction Lamp

Right: HC-CARGO 171927. Multi-plug: HC-CARGO 171788, 172066.

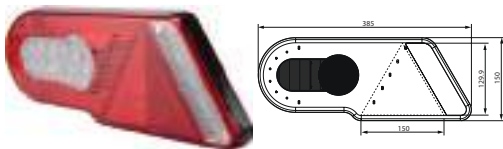

Voltage: 12-24

Dim.: 385x150x34.1 mm
Dist. mount. holes:
152 mm

Type: LED
Shape: Rectangular
Reflector: w/
Flasher light: w/
Rear/fog lamp: w/
Reverse light: w/
Tail light: w/
Stop light: w/
RH/LH: LH
Tightness norm: IP 67
Approvals: CE
E-approval: Yes

171929 LED Multifunction Lamp

Left: HC-CARGO 171930. Multi-plug: HC-CARGO 171788, 172066.



Voltage: 12-24

Dim.: 240.3x140x31 mm
Dist. mount. holes:
152 mm

Type: LED
Shape: Rectangular
Reflector: w/
Flasher light: w/
Rear/fog lamp: w/
Reverse light: w/
Tail light: w/
Stop light: w/
RH/LH: RH
Tightness norm: IP 67
Approvals: CE
E-approval: Yes

171930 LED Multifunction Lamp

Right: HC-CARGO 171929. Multi-plug: HC-CARGO 171788, 172066.

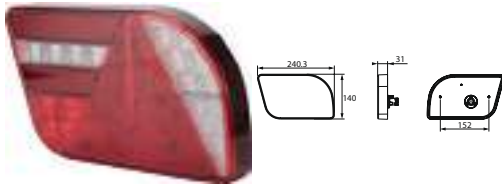

Voltage: 12-24

Dim.: 240.3x140x31 mm
Dist. mount. holes:
152 mm

Type: LED
Shape: Rectangular
Reflector: w/
Flasher light: w/
Rear/fog lamp: w/
Reverse light: w/
Tail light: w/
Stop light: w/
RH/LH: LH
Tightness norm: IP 67
Approvals: CE
E-approval: Yes

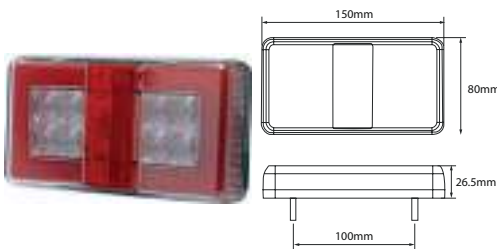
171952 LED Multifunction Lamp

Voltage: 12-24

Dim.: 150x80x26.5 mm
Cable length: 300 mm
Dist. mount. holes:
100 mm

Mount.: 2 screws
Reflector: w/
No./reflectors: 1
Flasher light: w/
Tail light: w/
Stop light: w/
Tightness norm: IP 67
Approvals: CE
E-approval: Yes

172061 LED Multifunction Lamp

Lens: HC-CARGO 172065. Left: HC-CARGO 172062. Plug: HC-CARGO 171788, 172066.



Voltage: 12-24

Dim.:
426.3x155.2x111.6 mm
Dist. mount. holes:
152 mm

Type: LED
Material: PP
Material/dome: Polycarbonate
Shape: Rectangular
Reflector: w/
Flasher light: w/
Rear/fog lamp: w/
Reverse light: w/
Sidemarker lamp: w/
Tail light: w/
Stop light: w/
RH/LH: RH
E-approval: Yes

172062 LED Multifunction Lamp

Lens: HC-CARGO 172065. Right: HC-CARGO 172061. Plug: HC-CARGO 171788, 172066.



Voltage: 12-24

Dim.:
426.3x155.2x111.6 mm
Dist. mount. holes:
152 mm

Type: LED
Material: PP
Material/dome: Polycarbonate
Shape: Rectangular
Reflector: w/
Flasher light: w/
Rear/fog lamp: w/
Reverse light: w/
Sidemarker lamp: w/
Tail light: w/
Stop light: w/
RH/LH: LH
E-approval: Yes

172063 LED Multifunction Lamp

Lens: HC-CARGO 172067. Left: HC-CARGO 172064. Plug: HC-CARGO 171788, 172066.



Voltage: 12-24

Dim.:
401.8x155.2x112.3 mm
Dist. mount. holes:
152 mm

Type: LED
Material: PP
Material/dome: Polycarbonate
Shape: Rectangular
Reflector: w/
Flasher light: w/
Rear/fog lamp: w/
Reverse light: w/
Sidemarker lamp: w/
Tail light: w/
Stop light: w/
RH/LH: RH
E-approval: Yes

172064 LED Multifunction Lamp

Lens: HC-CARGO 172067. Right: HC-CARGO 172063. Plug: HC-CARGO 171788, 172066.



Voltage: 12-24

Dim.: 401.8x155.2x112.3 mm
Dist. mount. holes: 152 mm

Type: LED
Material: PP
Material/dome: Polycarbonate
Shape: Rectangular
Reflector: w/
Flasher light: w/
Rear/fog lamp: w/
Reverse light: w/
Sidemarker lamp: w/
Tail light: w/
Stop light: w/
RH/LH: LH
E-approval: Yes

SPARE PARTS
172065 Lens, Rear Lamp

Servicing: HC-CARGO 172061, 172062

NEW PRODUCT
www.hc-cargo.com

Dim.: 401.8x155.2 mm

Material/dome: Polycarbonate
RH/LH: RH/LH

172067 Lens, Rear Lamp

Servicing: HC-CARGO 172063, 172064



Dim.: 401.8x155.2 mm

Material/dome: Polycarbonate
RH/LH: RH/LH

ACCESSORIES
160970 Load Resistor 12 V

Contains: 2 pcs.



Voltage: 12
Amp: 2
Watt: 50

Length: 50 mm
Width: 15 mm

160971 Load Resistor 24 V

Contains: 2 pcs.



Voltage: 24
Amp: 1
Watt: 50

Length: 50 mm
Width: 15 mm

TRAILER LAMPS CONVENTIONAL (TRUCKS)
171192 Multi Function Lamp

Mounting kit: HC-CARGO 171266. Lens: HC-CARGO 171237.

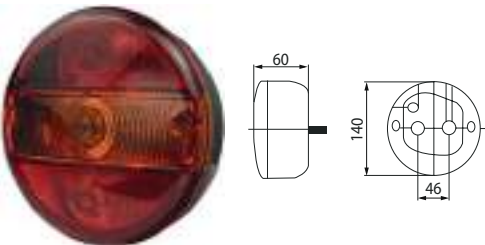

Bulb incl.: No
Watt 1: 21
Watt 2: 5

Dim.: 140x60 mm
OD: 140 mm
Dist. mount. holes: 46 mm

Socket type 1: BA15S
Socket type 2: BA15S
Material: Shockproof plastic
Shape: Round
Fixing screw: 2
Flasher light: w/
Numberplate light: w/
Tail light: w/
Stop light: w/
E-approval: Yes

171193 Multi Function Lamp

Mounting kit: HC-CARGO 171266. Lens: HC-CARGO 171237.

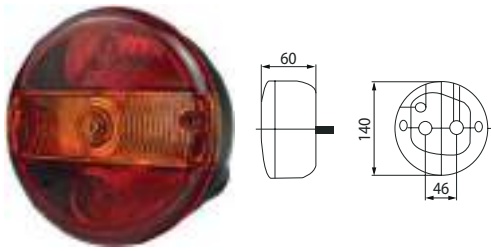

Bulb incl.: No
Watt 1: 21
Watt 2: 5

Dim.: 140x60 mm
OD: 140 mm
Dist. mount. holes: 46 mm

Socket type 1: BA15S
Socket type 2: BA15S
Material: Shockproof plastic
Shape: Round
Fixing screw: 2
Flasher light: w/
Tail light: w/
Stop light: w/
E-approval: Yes

171194 Multi Function Lamp

Mounting kit: HC-CARGO 171266. Lens: HC-CARGO 171237.

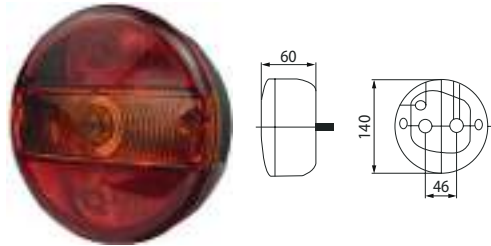

Bulb incl.: No
Watt 1: 21
Watt 2: 5

Dim.: 140x60 mm
OD: 140 mm
Dist. mount. holes: 45 mm

Socket type 1: BA15S
Socket type 2: BA15S
Material: Shockproof plastic
Shape: Round
Fixing screw: 2
Flasher light: w/
Numberplate light: w/
Tail light: w/
Stop light: w/
E-approval: Yes

171195 Multi Function Lamp

Mounting kit: HC-CARGO 171266. Lens: HC-CARGO 171237.

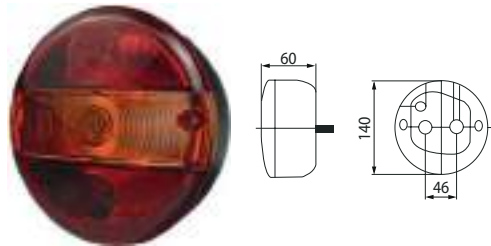

Bulb incl.: No
Watt 1: 21
Watt 2: 5

Dim.: 140x60 mm
OD: 140 mm
Dist. mount. holes: 46 mm

Socket type 1: BA15S
Socket type 2: BA15S
Material: Shockproof plastic
Shape: Round
Fixing screw: 2
Flasher light: w/
Tail light: w/
Stop light: w/
E-approval: Yes

171328 Multi Function Lamp

Lens: HC-CARGO 171330.

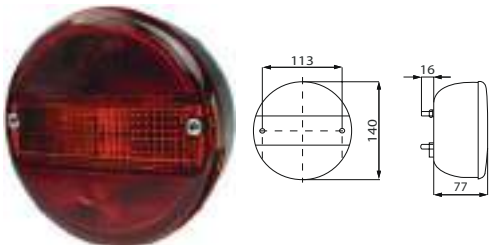

Bulb incl.: No
Watt 1: 21
Watt 2: 5

Dim.: 140x77 mm
OD: 140 mm
Dist. mount. holes: 45 mm

Socket type 1: BA15S
Socket type 2: BA15S
Material: Shockproof plastic
Shape: Circular
Fixing screw: 2
Flasher light: w/
Numberplate light: w/
Tail light: w/
Stop light: w/
E-approval: Yes

171329 Multi Function Lamp

Mounting kit: HC-CARGO 171266. Lens: HC-CARGO 171330.

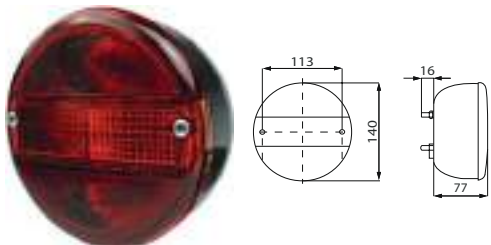

Bulb incl.: No

Dim.: 140x77 mm
OD: 140 mm
Dist. mount. holes: 45 mm

Socket type: BA15S
Material: Shockproof plastic
Shape: Circular
Fixing screw: 2
Flasher light: w/
Tail light: w/
Stop light: w/
E-approval: Yes

171870 Multi Function Lamp

Servicing: HC-CARGO 171818, 171872

Multi connector: HC-CARGO 171372, 171373. Lens: HC-CARGO 171834. Right: HC-CARGO 171871.

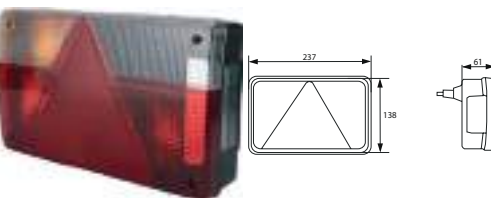

Bulb incl.: Yes
Voltage: 12

Dim.: 237x138x61 mm

Shape: Rectangular
Flasher light: w/
Numberplate light: w/
Rear/fog lamp: w/
Sidemarker: w/
Stop light: w/
RH/LH: LH
E-approval: Yes

171871 Multi Function Lamp

Servicing: HC-CARGO 171818, 171872

Multi connector: HC-CARGO 171372, 171373. Lens: HC-CARGO 171833. Left: HC-CARGO 171872.

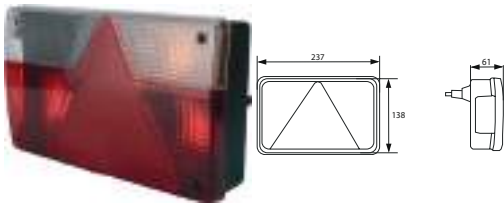

Bulb incl.: Yes
Voltage: 12

Dim.: 237x138x61 mm

Shape: Rectangular
Flasher light: w/
Numberplate light: w/
Rear/fog lamp: w/
Sidemarker: w/
Stop light: w/
RH/LH: RH
E-approval: Yes

171917 Multi Function Lamp

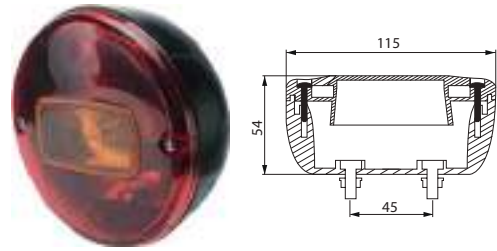

Bulb incl.: No
Watt: 5
Watt 2: 18
Watt 3: 18

Dim.: 115x54 mm
OD: 115 mm
Dist. mount. holes:
45 mm

Bulb type 1: 10.5x36 mm
Bulb type 2: 15x41 mm
Bulb type 3: 15x41 mm
Socket type: S8.5
Socket type 2: S8.5
Socket type 3: S8.5
Colour/glass: Red/yellow
Material/dome: PMMA
Shape: Round
Fixing screw: 2
Flasher light: w/
Tail light: w/
Stop light: w/
RH/LH: RH/LH

SPARE PARTS

170910 Lens, Rear Lamp

Servicing: HC-CARGO 170909

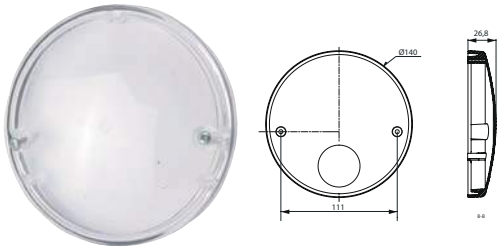

Dim.: 140x26.8 mm
Dist. mount. holes:
111 mm

Colour: White
Shape: Round

171237 Lens, Rear Lamp

Servicing: HC-CARGO 171192, 171193, 171194, 171195



OD: 140 mm

Type: Tail lamp
Material: Plastic
Shape: Circular
RH/LH: RH/LH

171330 Lens, Rear Lamp

Servicing: HC-CARGO 171328, 171329



OD: 140 mm

Shape: Circular
RH/LH: RH/LH

ACCESSORIES

171788 Multiconnector 7 pin

Servicing: HC-CARGO 171506, 171756, 171757, 171802, 171803, 171927, 171928, 171929, 171930, 172061, 172062, 172063, 172064

Gasket: HC-CARGO 192178. Terminal: HC-CARGO 193250.



Type/terminal: Round
Colour: Black
No./poles: 7
Plug: Female

172066 Multiconnector 7 pin

Servicing: HC-CARGO 171506, 171756, 171757, 171802, 171803, 171927, 171928, 171929, 171930, 172061, 172062, 172063, 172064



Type/terminal: Round
Colour: Black
No./poles: 7
Plug: Female

181627 Bayonet connector

Servicing: HC-CARGO 181617



Voltage: 12

Mount.: Terminal
No./poles: 8

TRAILER LAMPS LED (TRUCKS)

170909 LED Fog/Reverse Lamp

Lens and o-ring: HC-CARGO 170910.

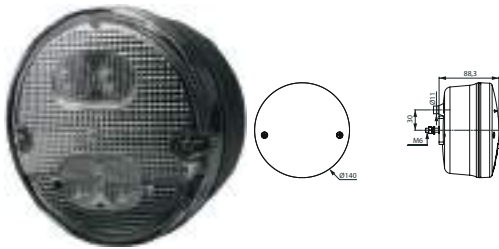

Voltage: 12/24

Dim.: 140x88.3 mm
OD: 140 mm
Dist. mount. holes:
45 mm

Type: LED
Colour/glass: White
Material: Shockproof plastic
Shape: Round
Fixing screw: 2
Rear/fog lamp: w/
Tail light: w/
LEDs: w/
No./LEDs: 4
E-approval: Yes

171549 LED Multifunction Lamp

Mounting kit: HC-CARGO 171266.

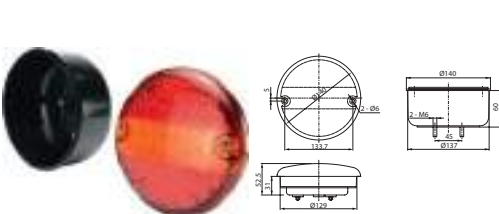

Voltage: 9-33

Dim.: 140x60 mm
Dist. mount. holes:
45 mm

Type: LED
Colour: Black
Material: Shockproof plastic
Shape: Circular
Fixing screw: 2
Flasher light: w/
Tail light: w/
Stop light: w/
No./LEDs: 63
E-approval: Yes

171665 LED Multifunction Lamp

Right: HC-CARGO 171666.

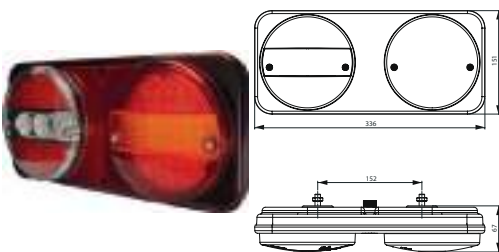

Voltage: 12/24

Dim.: 336x151x67 mm
Dist. mount. holes:
152 mm

Type: LED
Material: Shockproof plastic
Shape: Rectangular
Reflector: w/
Flasher light: w/
Reverse light: w/
Tail light: w/
Stop light: w/
RH/LH: LH
E-approval: Yes

171666 LED Multifunction Lamp

Left: HC-CARGO 171665.

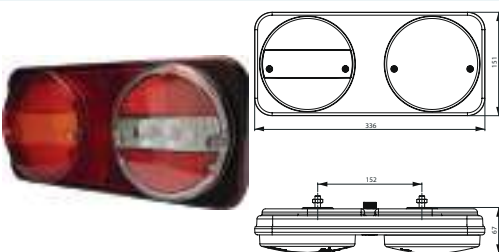

Voltage: 12/24

Dim.: 336x151x67 mm
Dist. mount. holes:
152 mm

Type: LED
Material: Shockproof plastic
Shape: Rectangular
Reflector: w/
Flasher light: w/
Reverse light: w/
Tail light: w/
Stop light: w/
RH/LH: RH
E-approval: Yes

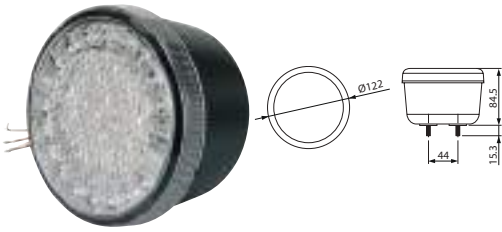
171725 LED Multifunction Lamp
Ring: amber, center: red.

Voltage: 12/24

Dim.: 122x84.5 mm
OD: 122 mm
Cable length: 150 mm
Dist. mount. holes: 44 mm

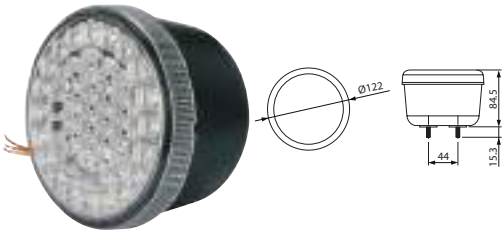
Type: LED
Material: Shockproof plastic
Material/dome: Shockproof plastic
Shape: Round
Fixing screw: 6
Flasher light: w/
Tail light: w/
Stop light: w/
No./LEDs: 44
E-approval: Yes

171726 LED Fog/Reverse Lamp
Ring: clear, center: red.

Voltage: 12/24

Dim.: 122x84.5 mm
OD: 122 mm
Cable length: 150 mm
Dist. mount. holes: 44 mm

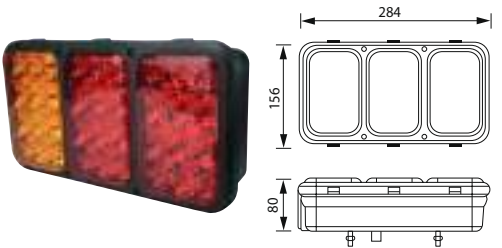
Type: LED
Material: Shockproof plastic
Material/dome: Shockproof plastic
Rear/fog lamp: w/
Reverse light: w/
No./LEDs: 38
E-approval: Yes

171772 LED Multifunction Lamp
White=ground. Brown=tail. Yellow=flasher. Red=stop.

Voltage: 24

Dim.: 284x156x102 mm
Dist. mount. holes: 130x78 mm

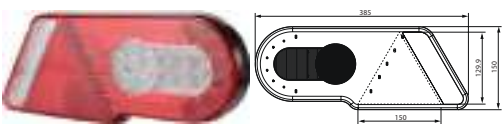
Type: Tail lamp
Material: Polypropylene
Material/dome: PMMA
Shape: Rectangular
Mount.: 4 screws
Reflector: w/
Flasher light: w/
Tail light: w/
Stop light: w/
No./LEDs: 3x16
RH/LH: RH/LH
E-approval: Yes

171927 LED Multifunction Lamp
Left: HC-CARGO 171928. Multi-plug: HC-CARGO 171788, 172066.

Voltage: 12-24

Dim.: 385x150x34.1 mm
Dist. mount. holes: 152.3 mm

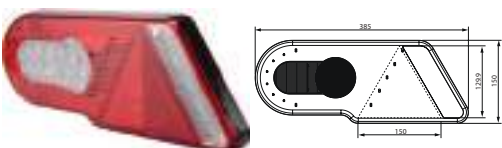
Type: LED
Shape: Rectangular
Reflector: w/
Flasher light: w/
Rear/fog lamp: w/
Reverse light: w/
Tail light: w/
Stop light: w/
RH/LH: RH
Tightness norm: IP 67
Approvals: CE
E-approval: Yes

171928 LED Multifunction Lamp
Right: HC-CARGO 171927. Multi-plug: HC-CARGO 171788, 172066.

Voltage: 12-24

Dim.: 385x150x34.1 mm
Dist. mount. holes: 152 mm

Type: LED
Shape: Rectangular
Reflector: w/
Flasher light: w/
Rear/fog lamp: w/
Reverse light: w/
Tail light: w/
Stop light: w/
RH/LH: LH
Tightness norm: IP 67
Approvals: CE
E-approval: Yes

171929 LED Multifunction Lamp

Left: HC-CARGO 171930. Multi-plug: HC-CARGO 171788, 172066.



Voltage: 12-24

Dim.: 240.3x140x31 mm
Dist. mount. holes:
152 mm

Type: LED
Shape: Rectangular
Reflector: w/
Flasher light: w/
Rear/fog lamp: w/
Reverse light: w/
Tail light: w/
Stop light: w/
RH/LH: RH
Tightness norm: IP 67
Approvals: CE
E-approval: Yes

171930 LED Multifunction Lamp

Right: HC-CARGO 171929. Multi-plug: HC-CARGO 171788, 172066.

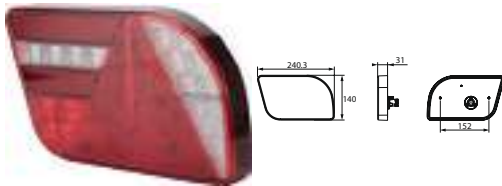

Voltage: 12-24

Dim.: 240.3x140x31 mm
Dist. mount. holes:
152 mm

Type: LED
Shape: Rectangular
Reflector: w/
Flasher light: w/
Rear/fog lamp: w/
Reverse light: w/
Tail light: w/
Stop light: w/
RH/LH: LH
Tightness norm: IP 67
Approvals: CE
E-approval: Yes

171952 LED Multifunction Lamp

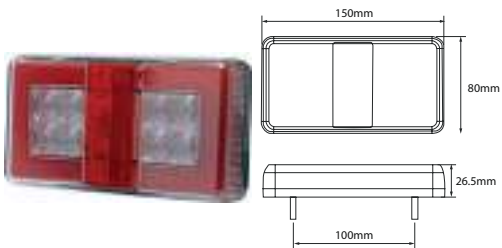

Voltage: 12-24

Dim.: 150x80x26.5 mm
Cable length: 300 mm
Dist. mount. holes:
100 mm

Mount.: 2 screws
Reflector: w/
No./reflectors: 1
Flasher light: w/
Tail light: w/
Stop light: w/
Tightness norm: IP 67
Approvals: CE
E-approval: Yes

SPARE PARTS

172065 Lens, Rear Lamp

Servicing: HC-CARGO 172061, 172062



Dim.: 401.8x155.2 mm

Material/dome: Polycarbonate
RH/LH: RH/LH

172067 Lens, Rear Lamp

Servicing: HC-CARGO 172063, 172064



Dim.: 401.8x155.2 mm

Material/dome: Polycarbonate
RH/LH: RH/LH

ACCESSORIES

160970 Load Resistor 12 V

Contains: 2 pcs.



Voltage: 12
Amp: 2
Watt: 50

Length: 50 mm
Width: 15 mm

160971 Load Resistor 24 V

Contains: 2 pcs.



Voltage: 24
Amp: 1
Watt: 50

Length: 50 mm
Width: 15 mm

TRAILER LAMPS (TRUCKS) W/ LED

172061 LED Multifunction Lamp

Lens: HC-CARGO 172065. Left: HC-CARGO 172062. Plug: HC-CARGO 171788, 172066.



Voltage: 12-24

Dim.: 426.3x155.2x111.6 mm
Dist. mount. holes: 152 mm

Type: LED
Material: PP
Material/dome: Polycarbonate
Shape: Rectangular
Reflector: w/
Flasher light: w/
Rear/fog lamp: w/
Reverse light: w/
Sidemarker lamp: w/
Tail light: w/
Stop light: w/
RH/LH: RH
E-approval: Yes

172062 LED Multifunction Lamp

Lens: HC-CARGO 172065. Right: HC-CARGO 172061. Plug: HC-CARGO 171788, 172066.



Voltage: 12-24

Dim.: 426.3x155.2x111.6 mm
Dist. mount. holes: 152 mm

Type: LED
Material: PP
Material/dome: Polycarbonate
Shape: Rectangular
Reflector: w/
Flasher light: w/
Rear/fog lamp: w/
Reverse light: w/
Sidemarker lamp: w/
Tail light: w/
Stop light: w/
RH/LH: LH
E-approval: Yes

172063 LED Multifunction Lamp

Lens: HC-CARGO 172067. Left: HC-CARGO 172064. Plug: HC-CARGO 171788, 172066.



Voltage: 12-24

Dim.: 401.8x155.2x112.3 mm
Dist. mount. holes: 152 mm

Type: LED
Material: PP
Material/dome: Polycarbonate
Shape: Rectangular
Reflector: w/
Flasher light: w/
Rear/fog lamp: w/
Reverse light: w/
Sidemarker lamp: w/
Tail light: w/
Stop light: w/
RH/LH: RH
E-approval: Yes

172064 LED Multifunction Lamp

Lens: HC-CARGO 172067. Right: HC-CARGO 172063. Plug: HC-CARGO 171788, 172066.



Voltage: 12-24

Dim.: 401.8x155.2x112.3 mm
Dist. mount. holes: 152 mm

Type: LED
Material: PP
Material/dome: Polycarbonate
Shape: Rectangular
Reflector: w/
Flasher light: w/
Rear/fog lamp: w/
Reverse light: w/
Sidemarker lamp: w/
Tail light: w/
Stop light: w/
RH/LH: LH
E-approval: Yes

TAIL LAMPS CONVENTIONAL			
171173 Tail Lamp			
	Watt: 5	Dim.: 62x62x45 mm Dist. mount. holes: 30 mm	Socket type: S8.5 Colour/glass: Red Material: Shockproof plastic Shape: Rectangular Fixing screw: 2 Sidemarker: w/ E-approval: Yes
171178 Tail Lamp			
	Watt: 5	Dim.: 70x36 mm Dist. mount. holes: 33 mm	Socket type: S8.5 Colour/glass: Red Material: Steel Fixing screw: 2 E-approval: Yes
171181 Tail Lamp			
	Watt: 5	Dim.: 80x42 mm Dist. mount. holes: 45 mm	Socket type: S8.5 Colour/glass: Red Material: Shockproof plastic Fixing screw: 2 E-approval: Yes
171331 Tail Lamp			
	Watt: 5	Dim.: 102x42x28 mm Dist. mount. holes: 65 mm	Socket type: S8.5 Colour/glass: Red Material: Plastic Fixing screw: 2 E-approval: Yes
TAIL LAMPS LED			
171580 LED Tail Lamp			
	Voltage: 12	Dim.: 104x36x19.6 mm Cable length: 500 mm Dist. mount. holes: 70 mm	Type: LED Colour/glass: Red Material: Shockproof plastic Shape: Rectangular Bracket: Angled Reflector: w/ Fixing screw: 2 Tail light: w/ No./LEDs: 3 E-approval: Yes
171599 LED Tail Lamp			
	Voltage: 24	Dim.: 104x36x20 mm Cable length: 500 mm Dist. mount. holes: 70 mm	Type: LED Colour/glass: Red Material: Shockproof plastic Shape: Rectangular Reflector: w/ Fixing screw: 2 Tail light: w/ No./LEDs: 3 E-approval: Yes

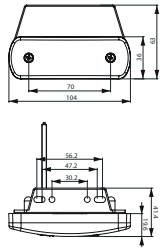
171600 LED Tail Lamp

Voltage: 24

 Dim.: 104x36x19.6 mm
 Cable length: 500 mm
 Dist. mount. holes:
 70 mm

 Type: LED
 Colour/glass: Red
 Material: Shockproof plastic
 Shape: Rectangular
 Bracket: Angled
 Reflector: w/
 Fixing screw: 2
 Tail light: w/
 No./LEDs: 3
 E-approval: Yes

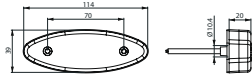
171605 LED Tail Lamp

Voltage: 24

 Dim.: 114x39x20 mm
 Cable length: 500 mm
 Dist. mount. holes:
 70 mm

 Type: LED
 Colour/glass: Red
 Material: Shockproof plastic
 Shape: Oval
 Reflector: w/
 Fixing screw: 2
 Tail light: w/
 No./LEDs: 3
 Approvals: ADR
 E-approval: Yes

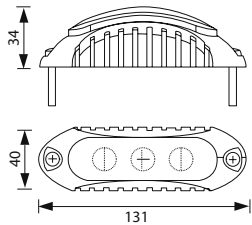
171635 LED Tail Lamp

Voltage: 9-36

 Dim.: 131x40x34 mm
 Dist. mount. holes:
 115 mm

 Type: LED
 Colour/glass: Red
 Material: PP/PMMA
 Shape: Oval
 Tail light: w/
 No./LEDs: 3
 E-approval: Yes

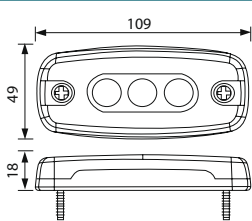
171637 LED Tail Lamp

 Voltage: 9-36
 Watt: 0.9

 Dim.: 109x49x18 mm
 Dist. mount. holes:
 83 mm

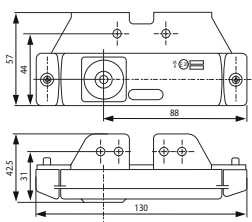
 Type: LED
 Colour/glass: Red
 Shape: Rectangular
 Reflector: w/
 Tail light: w/
 No./LEDs: 3
 E-approval: Yes

171719 LED Tail Lamp

Voltage: 12/24

 Dim.: 130x57x42.5 mm
 Dist. mount. holes:
 50 mm

 Type: LED
 Colour/glass: Red
 Material: Shockproof plastic
 Shape: Rectangular
 Bracket: Angled
 Reflector: w/
 Tail light: w/
 No./LEDs: 1
 E-approval: Yes

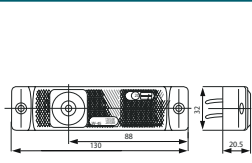
171720 LED Tail Lamp

Voltage: 12/24

 Dim.: 130x32x20.5 mm
 Dist. mount. holes:
 50 mm



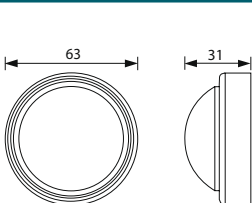





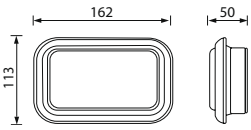

 Type: LED
 Colour/glass: Red
 Material: Shockproof plastic
 Shape: Rectangular
 Reflector: w/
 Tail light: w/
 No./LEDs: 1
 E-approval: Yes

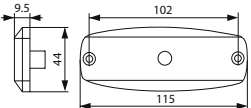
171743 LED Tail Lamp

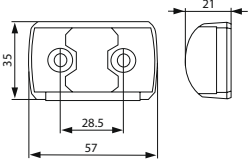
Voltage: 9-36

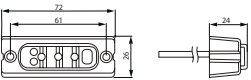
 Dim.: 63x31 mm
 Cable length: 300 mm
 Dist. mount. holes:
 30 mm

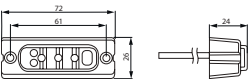
 Type: LED
 Colour: Black
 Colour/glass: Red
 Material: PVC
 Material/dome: PMMA
 Mount.: 2 screws
 Tail light: w/
 No./LEDs: 3
 Approvals: ADR/SAE
 E-approval: Yes

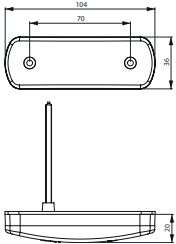
	EL. SPECIFICATIONS	DIMENSIONS	ADDITIONAL SPECIFICATIONS
171771 LED Tail Lamp	 	Voltage: 24 Watt: 2.5 Dim.: 162x113x50 mm	Type: Tail lamp Colour/glass: Red Material: ABS plastic Material/dome: PMMA Shape: Rectangular Mount.: Plan installation Tail light: w/ Stop light: w/ No./LEDs: 16 RH/LH: RH/LH E-approval: Yes
171840 LED Tail Lamp	 	Voltage: 12/24 Watt: 0.45-1.6 Dim.: 115x44x9.5 mm Cable length: 5000 mm Dist. mount. holes: 102 mm	Type: LED Colour: White Colour/glass: Red Material: Polycarbonate Material/dome: Polycarbonate Shape: Rectangular Mount.: 2 screws Reflector: w/ Tail light: w/ No./LEDs: 3 Tightness norm: IP 67 Approvals: SAE E-approval: Yes
171843 LED Tail Lamp	 	Voltage: 12/24 Dim.: 57x35x21 mm Cable length: 400 mm Dist. mount. holes: 28 mm	Type: LED Colour: Black Colour/glass: Red Shape: Rectangular Fixing screw: 2 Tail light: w/ No./LEDs: 2 Tightness norm: IP 67 E-approval: Yes
171861 LED Tail Lamp	 	Voltage: 12/24 Watt: 0.3-0.6 Dim.: 72x26x24 mm Cable length: 5000 mm	Type: LED Colour: Black Colour/glass: Red Material: PP Material/dome: PMMA Shape: Rectangular Fixing screw: 2 Tail light: w/ No./LEDs: 3 Approvals: CE E-approval: Yes
171867 LED Tail Lamp	 	Voltage: 12/24 Watt: 0.3-0.6 Dim.: 72x26x24 mm Cable length: 5000 mm	Type: LED Colour: Black Colour/glass: Red Material: PP Material/dome: PMMA Shape: Rectangular Bracket: Adjustable Fixing screw: 2 Tail light: w/ No./LEDs: 3 Approvals: CE E-approval: Yes
172034 LED Tail Lamp	 	Voltage: 12/24 Dim.: 104x36x20 mm Cable length: 500 mm Dist. mount. holes: 70 mm	Type: LED Colour/glass: Red Material: Shockproof plastic Shape: Rectangular Reflector: w/ Fixing screw: 2 Tail light: w/ No./LEDs: 3 E-approval: Yes

172035 LED Tail Lamp

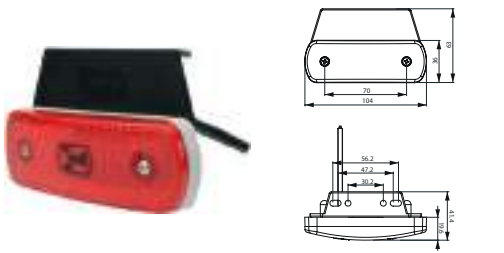

Voltage: 12/24

Dim.: 104x36x20 mm
Cable length: 500 mm
Dist. mount. holes:
70 mm

Type: LED
Colour/glass: Red
Material: Shockproof plastic
Shape: Rectangular
Bracket: Angled
Reflector: w/
Fixing screw: 2
Tail light: w/
No./LEDs: 3
E-approval: Yes

172040 LED Tail Lamp

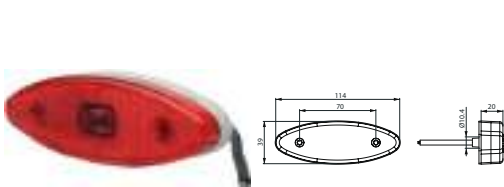

Voltage: 12/24

Dim.: 114x39x20 mm
Cable length: 500 mm
Dist. mount. holes:
70 mm

Type: LED
Colour/glass: Red
Material: Shockproof plastic
Shape: Oval
Reflector: w/
Fixing screw: 2
Tail light: w/
No./LEDs: 3
Approvals: ADR
E-approval: Yes

TAIL POSITION LAMPS CONVENTIONAL

170552 Tail/Position Lamp

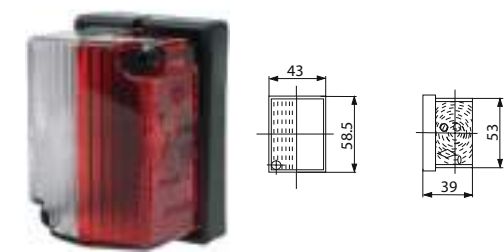

Bulb incl.: No
Watt: 5

Dim.: 58.5x43x39 mm
Dist. mount. holes:
25 mm

Socket type: S8.5
Colour/glass: Red/white
Material: Shockproof plastic
Shape: Rectangular
Fixing screw: 2
Sidemarker: w/
Tail light: w/
RH/LH: RH/LH
E-approval: Yes

170632 Tail/Position Lamp

Lens: HC-CARGO 170635, 170636.

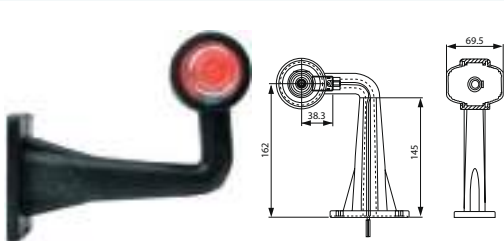

Bulb incl.: No
Watt: 10

Dim.: 162x69.5 mm
Dist. mount. holes:
76 mm

Socket type: BA15S
Colour/glass: Red/white
Sidemarker: w/
Tail light: w/
E-approval: Yes

170633 Tail/Position Lamp

Lens: HC-CARGO 170635, 170636.

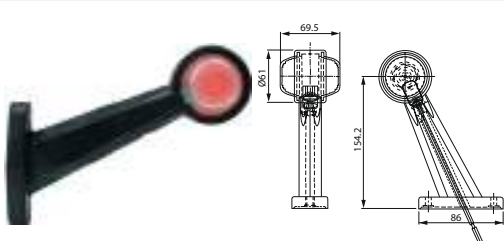

Bulb incl.: No
Watt: 10

Dim.: 154.2x69.5 mm
Dist. mount. holes:
75 mm

Socket type: BA15S
Colour/glass: Red/white
Sidemarker: w/
Tail light: w/
E-approval: Yes

170640 Tail/Position Lamp

Lens: HC-CARGO 170642, 170641. Bulb holder: HC-CARGO 170671.

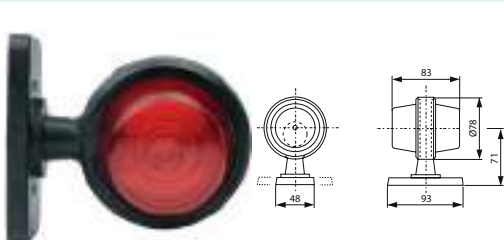

Bulb incl.: No
Watt: 5

Dim.: 110x78x93 mm
OD: 60 mm
Dist. mount. holes:
75 mm

Socket type: BA15S
Colour/glass: Red/white
Shape: Round
Sidemarker: w/
Tail light: w/
E-approval: Yes

170668 Tail/Position Lamp

Lens: HC-CARGO 170642, 170641. Bulb holder: HC-CARGO 170671. Bulbs: HC-CARGO 170773.

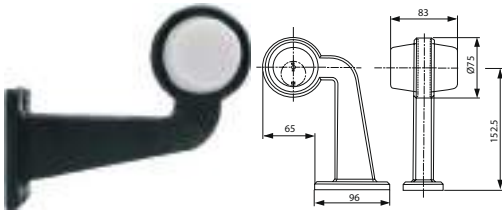

Bulb incl.: No
Watt: 5

Dim.: 152.5x83 mm
OD: 60 mm
Dist. mount. holes:
74 mm

Socket type: BA15S
Colour/glass: Red/white
Sidemarker: w/
Tail light: w/
E-approval: Yes

171196 Tail/Position Lamp

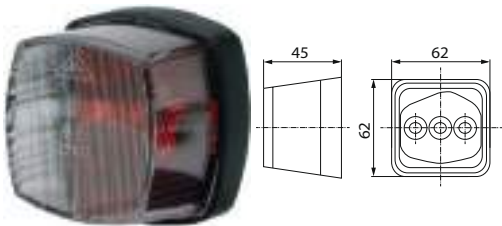

Bulb incl.: No
Watt: 5

Dim.: 62x62x45 mm
Dist. mount. holes:
30 mm

Socket type: S8.5
Colour/glass: Red/white
Material: Shockproof plastic
Shape: Square
Fixing screw: 2
Sidemarker: w/
Tail light: w/
RH/LH: RH/LH
E-approval: Yes

171627 Tail/Position Lamp

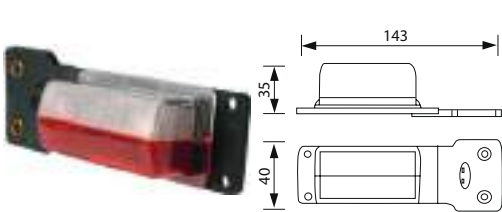

Bulb incl.: No
Voltage: 12/24
Watt: 5

Dim.: 143x40x35 mm
Dist. mount. holes:
30 mm

Socket type: S8.5
Material: Plastic
Shape: Rectangular
Sidemarker: w/
Tail light: w/
Approvals: ADR
E-approval: Yes

171706 Tail/Position Lamp

Servicing: HC-CARGO 171627

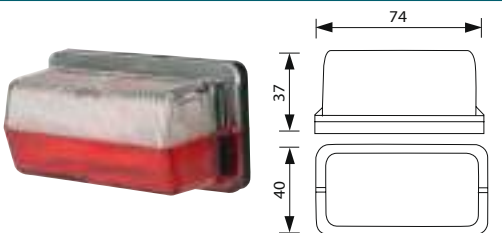

Bulb incl.: No
Voltage: 12/24
Watt: 5

Dim.: 74x40x37 mm
Dist. mount. holes:
45 mm

Socket type: S8.5
Shape: Rectangular
Sidemarker: w/
Tail light: w/
Approvals: ADR
E-approval: Yes

SPARE PARTS

170635 Lens

Servicing: HC-CARGO 170632, 170633



Colour/glass: White
Material: Glass
Shape: Round

170636 Lens

Servicing: HC-CARGO 170632, 170633



Colour/glass: Red
Material: Glass
Shape: Round

170641 Lens

Servicing: HC-CARGO 170640, 170668



Colour/glass: Red
Material: Glass
Shape: Round

170642 Lens

Servicing: HC-CARGO 170640, 170668



Colour/glass: White
Material: Glass

170671 Bulb Holder

Servicing: HC-CARGO 170640, 170668, 170713



TAIL POSITION LAMPS LED

171528 LED Tail-Position Lamp

Flange 100x41 mm.

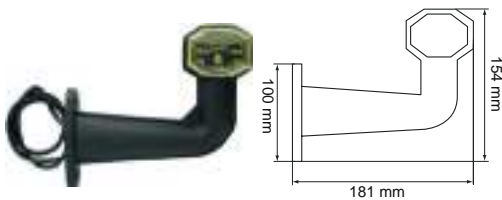

Voltage: 24

Dim.: 181x154x48 mm
Cable length: 700 mm
Dist. mount. holes:
73 mm

Type: LED
Colour/glass: Red/white
Material: Rubber
Material/dome: Shockproof plastic
Fixing screw: 2
Sidemarker: w/
Tail light: w/
No./LEDs: 2x1
RH/LH: RH/LH
E-approval: Yes

171529 LED Tail-Position Lamp

Flange 100x41 mm.

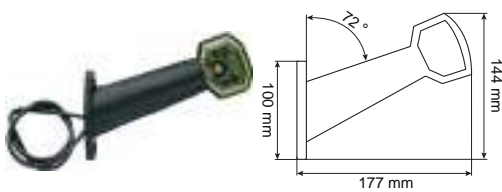

Voltage: 24

Dim.: 177x144x48 mm
Cable length: 700 mm
Dist. mount. holes:
73 mm

Type: LED
Colour/glass: Red/white
Material: Rubber
Material/dome: Shockproof plastic
Fixing screw: 2
Sidemarker: w/
Tail light: w/
No./LEDs: 2x1
RH/LH: RH/LH
E-approval: Yes

171530 LED Tail-Position Lamp

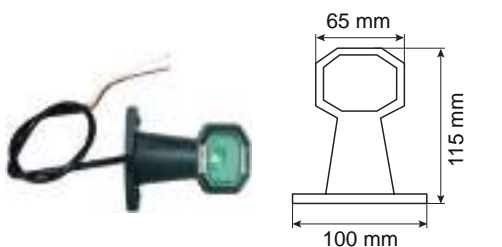

Voltage: 24

Dim.: 115x65x48 mm
Cable length: 700 mm
Dist. mount. holes:
73 mm

Type: LED
Colour/glass: Red/white
Material: Rubber
Material/dome: Shockproof plastic
Fixing screw: 2
Sidemarker: w/
Tail light: w/
No./LEDs: 2x1
RH/LH: RH/LH
E-approval: Yes

171591 LED Tail-Position Lamp



Voltage: 9-36

Dim.: 193x162x70 mm
Dist. mount. holes:
78 mm

Type: LED
Colour/glass: Red/white
Sidemarker: w/
Tail light: w/
No./LEDs: 2x3
RH/LH: RH/LH
Approvals: ADR/SAE
E-approval: Yes

	EL. SPECIFICATIONS	DIMENSIONS	ADDITIONAL SPECIFICATIONS
171592 LED Tail-Position Lamp			
	Voltage: 9-36	Dim.: 184x145x70 mm Dist. mount. holes: 78 mm	Type: LED Colour/glass: Red/white Sidemarkers: w/ Tail light: w/ No./LEDs: 2x3 RH/LH: RH/LH Approvals: SAE E-approval: Yes
171593 LED Tail-Position Lamp			
	Voltage: 9-36	Dim.: 75x89x62 mm OD: 45 mm Dist. mount. holes: 78 mm	Type: LED Colour/glass: Red/white Material: Rubber Sidemarkers: w/ Tail light: w/ No./LEDs: 2x3 RH/LH: RH/LH Approvals: ADR/SAE E-approval: Yes
171617 LED Tail-Position Lamp			
	Voltage: 9-36	Dim.: 96x76x63 mm OD: 76 mm Dist. mount. holes: 78 mm	Type: LED Colour/glass: Red/white Material: Synthetic rubber Sidemarkers: w/ Tail light: w/ No./LEDs: 2x3 RH/LH: RH/LH Approvals: ADR/SAE E-approval: Yes
171730 LED Tail/Position/Side Marker			
<i>w/ 128 mm rubber arm. Cover of click-in connector HC-CARGO 172016.</i>			
	Voltage: 12/24	Dim.: 127.1x100.3 mm Cable length: 500 mm Dist. mount. holes: 78 mm	Type: LED Mount.: 2 screws Sidemarkers: w/ Sidemarkers lamp: w/ Tail light: w/ No./LEDs: 7 RH/LH: RH/LH Tightness norm: IP 67 E-approval: Yes
171731 LED Tail/Position/Side Marker			
<i>w/ 145 mm rubber arm. Cover of click-in connector HC-CARGO 172016.</i>			
	Voltage: 12/24	Dim.: 142.2x130.5x40.5 mm Cable length: 450 mm Dist. mount. holes: 52 mm	Type: LED Colour: Black Material: Rubber Mount.: 4 holes Sidemarkers: w/ Sidemarkers lamp: w/ Tail light: w/ No./LEDs: 9 RH/LH: RH E-approval: Yes
171732 LED Tail/Position/Side Marker			
<i>Cover of click-in connector HC-CARGO 172016.</i>			
	Voltage: 12/24	Dim.: 142.2x130.5x40.5 mm Cable length: 450 mm Dist. mount. holes: 52 mm	Type: LED Colour: Black Material: Rubber Mount.: 4 holes Sidemarkers: w/ Sidemarkers lamp: w/ Tail light: w/ No./LEDs: 9 RH/LH: LH E-approval: Yes

171733 LED Tail/Position/Side Marker

Cover of click-in connector HC-CARGO 172016.

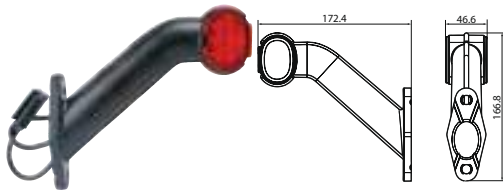

Voltage: 12/24

 Dim.: 172.4x166.8x46.6 mm
 Cable length: 500 mm
 Dist. mount. holes: 78 mm

 Type: LED
 Mount.: 2 screws
 Sidemarker: w/
 Sidemarker lamp: w/
 Tail light: w/
 No./LEDs: 7
 RH/LH: RH

171734 LED Tail/Position/Side Marker

Cover of click-in connector HC-CARGO 172016.



Voltage: 12/24

 Dim.: 172.4x166.8x46.6 mm
 Cable length: 500 mm
 Dist. mount. holes: 78 mm

 Type: LED
 Mount.: 2 screws
 Sidemarker: w/
 Sidemarker lamp: w/
 Tail light: w/
 No./LEDs: 7
 RH/LH: LH

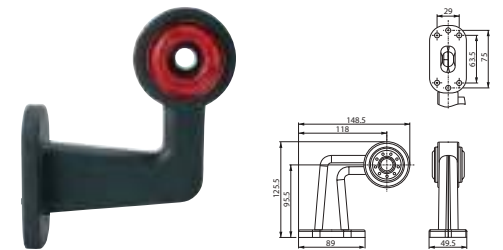
171958 LED Tail-Position Lamp

Voltage: 12-24

 Dim.: 148.5x125.5x89 mm
 Cable length: 300 mm
 Dist. mount. holes: 63.5/75/29 mm

 Type: LED
 Colour: Black
 Colour/glass: Red/white
 Material: Rubber
 Material/dome: Shockproof plastic
 Shape: Round
 Mount.: 6 screws
 Sidemarker: w/
 Tail light: w/
 RH/LH: RH
 Tightness norm: IP 68
 E-approval: Yes

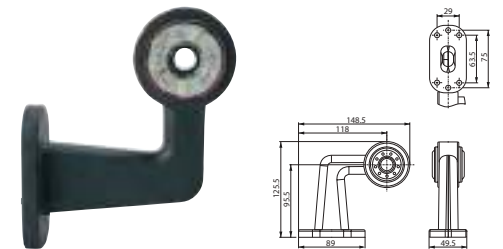
171959 LED Tail-Position Lamp

Voltage: 12-24

 Dim.: 148.5x125.5x89 mm
 Cable length: 300 mm
 Dist. mount. holes: 63.5/75/29 mm

 Type: LED
 Colour: Black
 Colour/glass: Red/white
 Material: Rubber
 Material/dome: Shockproof plastic
 Shape: Round
 Mount.: 6 screws
 Sidemarker: w/
 Tail light: w/
 RH/LH: LH
 Tightness norm: IP 68
 E-approval: Yes

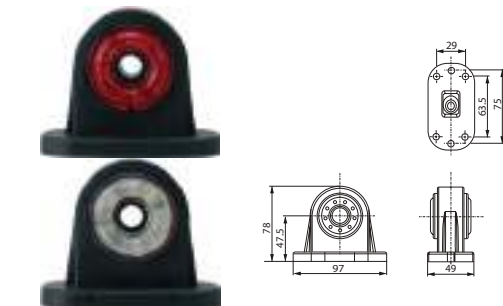
171960 LED Tail-Position Lamp

Voltage: 12-24

 Dim.: 97x78x49 mm
 Cable length: 300 mm
 Dist. mount. holes: 75/63.5/29 mm

 Type: LED
 Colour: Black
 Colour/glass: Red/white
 Material: Rubber
 Material/dome: Shockproof plastic
 Shape: Round
 Mount.: 6 screws
 Sidemarker: w/
 Tail light: w/
 RH/LH: RH/LH
 Tightness norm: IP 68
 E-approval: Yes

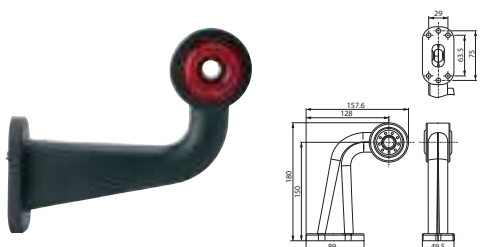
171961 LED Tail-Position Lamp

Voltage: 12-24

 Dim.: 180x157.6x89 mm
 Cable length: 300 mm
 Dist. mount. holes: 75/63.5/29 mm

 Type: LED
 Colour: Black
 Colour/glass: Red/white
 Material: Rubber
 Material/dome: Shockproof plastic
 Shape: Round
 Mount.: 6 screws
 Sidemarker: w/
 Tail light: w/
 RH/LH: RH
 Tightness norm: IP 68
 E-approval: Yes

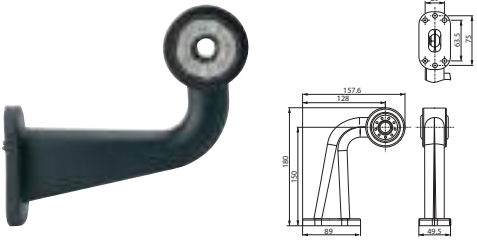
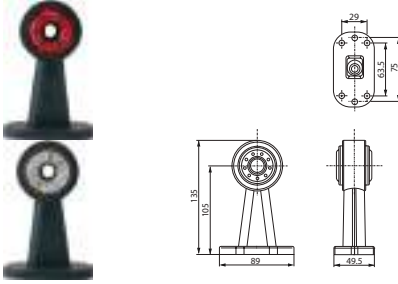
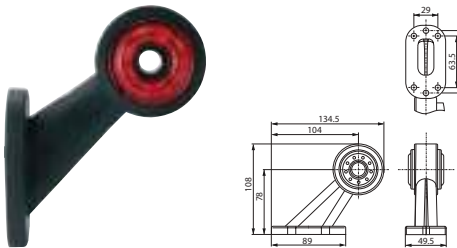
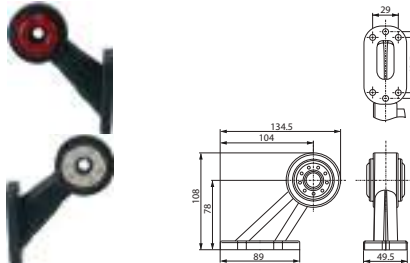
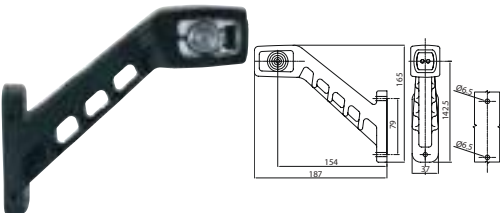
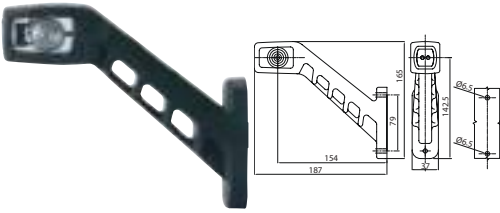
		EL. SPECIFICATIONS	DIMENSIONS	ADDITIONAL SPECIFICATIONS
171962 LED Tail-Position Lamp			Voltage: 12-24 Dim.: 180x157.6x89 mm Cable length: 300 mm Dist. mount. holes: 75/63.5/29 mm	Type: LED Colour: Black Colour/glass: Red/white Material: Rubber Material/dome: Shockproof plastic Shape: Round Mount.: 6 screws Sidemarkers: w/ Tail light: w/ RH/LH: LH Tightness norm: IP 68 E-approval: Yes
171963 LED Tail-Position Lamp			Voltage: 12-24 Dim.: 135x89x49.5 mm Cable length: 300 mm Dist. mount. holes: 75/63.5/29 mm	Type: LED Colour: Black Colour/glass: Red/white Material: Rubber Material/dome: Shockproof plastic Shape: Round Mount.: 6 screws Sidemarkers: w/ Tail light: w/ RH/LH: RH/LH Tightness norm: IP 68 E-approval: Yes
171964 LED Tail-Position Lamp			Voltage: 12-24 Dim.: 134.5x108x89 mm Cable length: 300 mm Dist. mount. holes: 75/63.5/29 mm	Type: LED Colour: Black Colour/glass: Red/white Material: Rubber Material/dome: Shockproof plastic Shape: Round Mount.: 6 screws Sidemarkers: w/ Tail light: w/ RH/LH: RH Tightness norm: IP 68 E-approval: Yes
171965 LED Tail-Position Lamp			Voltage: 12-24 Dim.: 134.5x108x89 mm Cable length: 300 mm Dist. mount. holes: 75/63.5/29 mm	Type: LED Colour: Black Colour/glass: Red/white Material: Rubber Material/dome: Shockproof plastic Shape: Round Mount.: 6 screws Sidemarkers: w/ Tail light: w/ RH/LH: LH Tightness norm: IP 68 E-approval: Yes
171966 LED Tail/Position/Side Marker			Voltage: 12-24 Dim.: 187x165x37 mm Cable length: 300 mm Dist. mount. holes: 79 mm	Type: LED Colour: Black Colour/glass: Transparent Material: Rubber Material/dome: Shockproof plastic Mount.: 2 screws Sidemarkers: w/ Sidemarkers lamp: w/ Tail light: w/ RH/LH: RH Tightness norm: IP 68 E-approval: Yes
171967 LED Tail/Position/Side Marker			Voltage: 12-24 Dim.: 187x165x37 mm Cable length: 300 mm Dist. mount. holes: 79 mm	Type: LED Colour: Black Colour/glass: Transparent Material: Rubber Material/dome: Shockproof plastic Mount.: 2 screws Sidemarkers: w/ Sidemarkers lamp: w/ Tail light: w/ RH/LH: LH Tightness norm: IP 68 E-approval: Yes

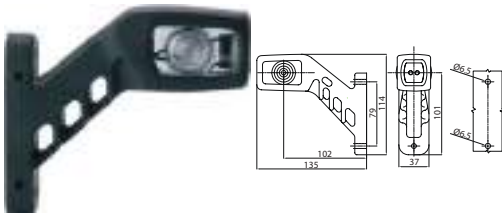
EL. SPECIFICATIONS
DIMENSIONS
ADDITIONAL SPECIFICATIONS
171968 LED Tail/Position/Side Marker

Voltage: 12-24

Dim.: 135x114x37 mm
Cable length: 300 mm
Dist. mount. holes: 79 mm

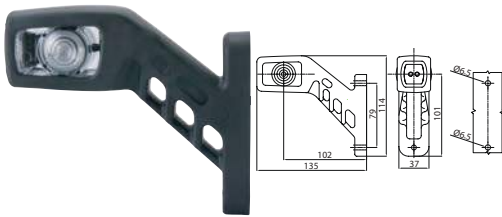
Type: LED
Colour: Black
Colour/glass: Transparent
Material: Rubber
Material/dome: Shockproof plastic
Mount.: 2 screws
Sidemarkers: w/
Sidemarkers lamp: w/
Tail light: w/
RH/LH: RH
Tightness norm: IP 68
E-approval: Yes

171969 LED Tail/Position/Side Marker

Voltage: 12-24

Dim.: 135x114x37 mm
Cable length: 300 mm
Dist. mount. holes: 79 mm

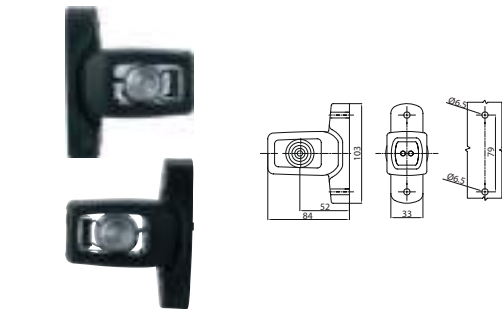
Type: LED
Colour: Black
Colour/glass: Transparent
Material: Rubber
Material/dome: Shockproof plastic
Mount.: 2 screws
Sidemarkers: w/
Sidemarkers lamp: w/
Tail light: w/
RH/LH: LH
Tightness norm: IP 68
E-approval: Yes

171970 LED Tail/Position/Side Marker

Voltage: 12-24

Dim.: 103x84x33 mm
Cable length: 300 mm
Dist. mount. holes: 79 mm

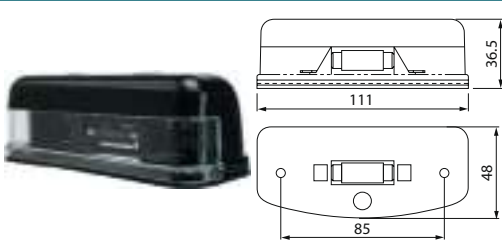
Type: LED
Colour: Black
Colour/glass: Transparent
Material: Rubber
Material/dome: Shockproof plastic
Mount.: 2 screws
Sidemarkers: w/
Sidemarkers lamp: w/
Tail light: w/
RH/LH: RH/LH
Tightness norm: IP 68
E-approval: Yes

NUMBERPLATE LAMPS CONVENTIONAL
170002 Numberplate Lamp
Servicing: Universal

Voltage: 12/24
Watt: 5

Dim.: 111x36.5x48 mm

Socket type: S8.5
Colour: Black
Shape: Rectangular
Approvals: CE

170936 Numberplate Lamp

Voltage: 12
Watt: 5





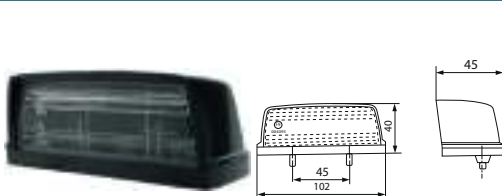





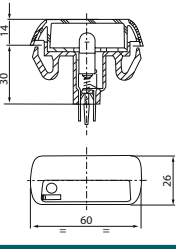

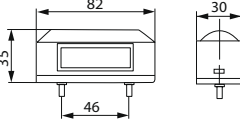
Dim.: 105x55x63 mm
Dist. mount. holes: 72 mm

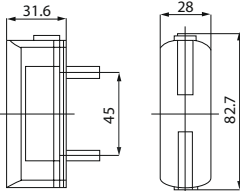
Type: Illumination of numberplate
Socket type: S8.5
Colour: Black
Material: Shockproof plastic
Fixing screw: 2
Numberplate light: w/
E-approval: Yes

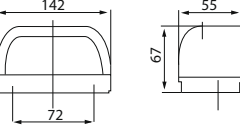
171045 Numberplate Lamp

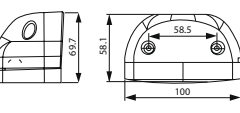
Voltage: 12/24
Watt: 5

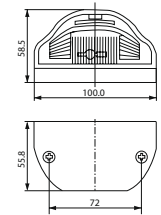
Dim.: 102x40x45 mm
Dist. mount. holes: 45 mm

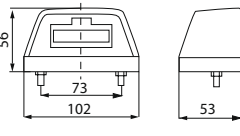
Type: Illumination of numberplate
Socket type: S8.5
Colour: Black
Material: Shockproof plastic
Shape: Rectangular
Fixing screw: 2
E-approval: Yes

EL. SPECIFICATIONS		DIMENSIONS		ADDITIONAL SPECIFICATIONS	
171164 Numberplate Lamp  		Servicing: Ford, Universal Voltage: 12 Watt: 5 Dim.: 60x44x26 mm		Type: Illumination of numberplate Socket type: T10 E-approval: Yes	
171166 Numberplate Lamp <i>Universal.</i>  		Voltage: 12/24 Watt: 5 Dim.: 82x35x30 mm Dist. mount. holes: 46 mm		Type: Illumination of numberplate Socket type: S8.5 Colour: Black Fixing screw: 2 Numberplate light: w/ E-approval: Yes	
171224 Numberplate Lamp  		Bulb incl.: No Voltage: 12/24 Watt: 5 Dim.: 82.7x28x31.6 mm Dist. mount. holes: 45 mm		Illumination of numberplate Socket type: S8.5 Colour: Black Material: Shockproof plastic Shape: Rectangular Fixing screw: 2 E-approval: Yes	
171225 Numberplate Lamp  		Bulb incl.: No Voltage: 12/24 Watt: 10 Dim.: 142x67x55 mm Dist. mount. holes: 72 mm		Type: Illumination of numberplate Socket type: BA15S Material: Shockproof plastic Fixing screw: 2 E-approval: Yes	
171345 Numberplate Lamp  		Bulb incl.: No Watt: 5 Dim.: 100x58.1x69.7 mm Dist. mount. holes: 58.5 mm		Type: Illumination of numberplate Socket type: S8.5 Colour: Black Material: Plastic Fixing screw: 2 E-approval: Yes	
171823 Numberplate Lamp  		Bulb incl.: No Watt: 5 Dim.: 100x58.5x55.8 mm Dist. mount. holes: 72 mm		Type: Illumination of numberplate Socket type: S8.5 Colour: Black Colour/glass: Red Material: Plastic Fixing screw: 2 Numberplate light: w/ E-approval: Yes	
<h2>NUMBERPLATE LAMPS LED</h2>					
171622 LED Numberplate Lamp  		Voltage: 24 Dim.: 102x56x53 mm Dist. mount. holes: 72 mm		Type: LED Colour: Black Colour/glass: Transparent Numberplate light: w/ No./LEDs: 4 E-approval: Yes	

	EL. SPECIFICATIONS	DIMENSIONS	ADDITIONAL SPECIFICATIONS
171624 LED Numberplate Lamp 	Voltage: 24	Dim.: 102x56x53 mm Dist. mount. holes: 73 mm	Type: LED Colour: Black Colour/glass: Red Shape: Rectangular Numberplate light: w/ LEDs: w/ E-approval: Yes
171709 LED Numberplate Lamp 	Voltage: 12/24	Dim.: 109x61x55.5 mm Dist. mount. holes: 85.5 mm	Type: LED Socket type: LED Colour: Red Material: Shockproof plastic Fixing screw: 2 Numberplate light: w/ E-approval: Yes
171714 LED Numberplate Lamp 	Voltage: 12/24	Dim.: 109x61x55.5 mm Dist. mount. holes: 85.5 mm	Type: LED Socket type: LED Colour: Black Material: Shockproof plastic Fixing screw: 2 Numberplate light: w/
171715 LED Numberplate Lamp 	Voltage: 12/24	Dim.: 82.5x39x31 mm Dist. mount. holes: 44 mm	Type: LED Socket type: LED Colour/glass: Red Material: Shockproof plastic Fixing screw: 2 Numberplate light: w/ Tightness norm: IP 68 E-approval: Yes
171716 LED Numberplate Lamp 	Voltage: 12/24	Dim.: 82.5x39x31 mm Dist. mount. holes: 44 mm	Type: LED Socket type: LED Colour: Black Material: Shockproof plastic Fixing screw: 2 Numberplate light: w/ E-approval: Yes
171737 LED Numberplate Lamp 	Voltage: 12	Dim.: 75x29x34 mm Cable length: 300 mm Dist. mount. holes: 65 mm	Type: LED Mount.: 2 screws Numberplate light: w/ No./LEDs: 3 E-approval: Yes
171738 LED Numberplate Lamp 	Voltage: 24	Dim.: 75x29x34 mm Cable length: 300 mm Dist. mount. holes: 65 mm	Type: LED Mount.: 2 screws Numberplate light: w/ No./LEDs: 3

171824 LED Numberplate Lamp



Voltage: 12/24
Watt: 0.5-1.1

Dim.: 100x58.5x55.8 mm
Cable length: 1000 mm
Dist. mount. holes: 72 mm

Type: LED
Colour: Black
Colour/glass: White
Material: Plastic
Fixing screw: 2
Numberplate light: w/
No./LEDs: 2
E-approval: Yes

172002 LED Numberplate Lamp

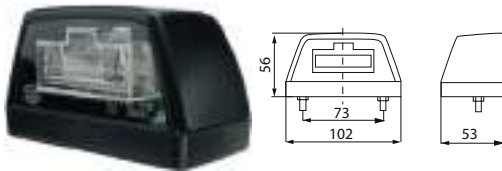

Voltage: 12

Dim.: 102x56x53 mm
Dist. mount. holes: 73 mm

Type: LED
Colour: Black
Colour/glass: Transparent
Material: Plastic
Numberplate light: w/
No./LEDs: 4
E-approval: Yes

172009 LED Numberplate Lamp

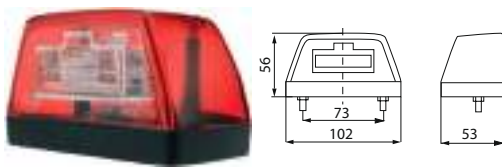

Voltage: 12

Dim.: 102x56x53 mm
Dist. mount. holes: 73 mm

Type: LED
Colour: Black
Colour/glass: Red
Material: Plastic
Shape: Rectangular
Numberplate light: w/
LEDs: w/
E-approval: Yes

TRAILER LIGHTING SETS

170809 Trailer Lighting Set

Light construction. 7-pole plug.

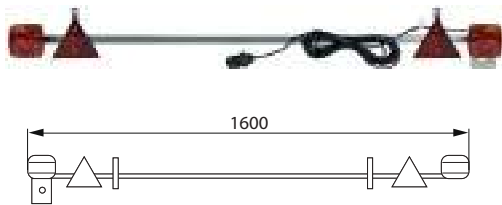

Bulb incl.: Yes
Voltage: 12

Dim.: 1600 mm
Cable length: 7500 mm

Material: Galvanised steel
No./lamps: 2
No./reflectors: 2
Flasher light: w/
Numberplate holder: w/
Stop light: w/

170828 Front/rear lighting set

7-pole plug. Tail-stop-flash lamp: HC-CARGO 170939. Flash-position lamp: HC-CARGO 170941. Magnet w/ metal bracket: HC-CARGO 170942.



Bulb incl.: Yes
Voltage: 12

Dim.: 107x100 mm
Cable length: 4500/7500 mm

Mount.: Magnetic
No./lamps: 2
Flasher light: w/
Sidemarker: w/
Tail light: w/
Stop light: w/

170829 Number Plate Holder

7-pole plug.



Bulb incl.: Yes
Voltage: 12

Dim.: 1050x146 mm
Cable length: 1500 mm

Reflector: w/
Numberplate holder: w/
Straps incl.: Yes

170835 Trailer Lighting Set

Light construction. 7-pole plug.

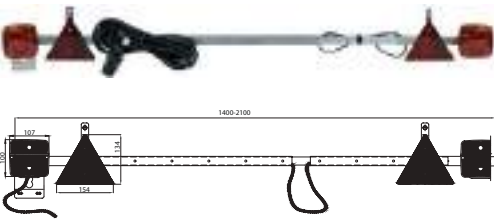

Bulb incl.: Yes
Voltage: 12

Dim.: 1400-2100 mm
Cable length:
12000 mm

Material: Galvanised steel
No./lamps: 2
No./reflectors: 2
Flasher light: w/
Numberplate holder: w/
Tail light: w/
Stop light: w/
Width/adjustable: w/

171049 Trailer Lighting Set

Extensible light construction. 7-pole plug.

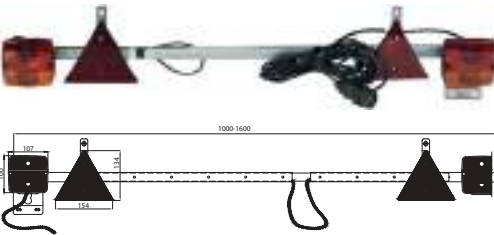

Bulb incl.: Yes
Voltage: 12

Dim.: 1000-1600 mm
Cable length: 7500 mm

Material: Galvanised steel
No./lamps: 2
No./reflectors: 2
Flasher light: w/
Numberplate holder: w/
Tail light: w/
Stop light: w/
Width/adjustable: w/

171818 Trailer lighting set

Lens: HC-CARGO 171833, 171834. Lamp: HC-CARGO 171870, 171871.

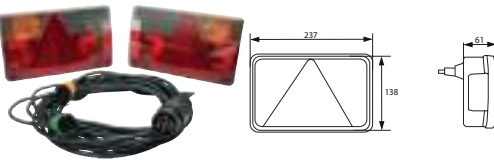

Bulb incl.: Yes
Voltage: 12

Dim.: 237x138x61 mm
Cable length:
2x5000 mm

Shape: Rectangular
No./lamps: 2
Flasher light: w/
Numberplate light: w/
Rear/fog lamp: w/
Tail light: w/
Stop light: w/
E-approval: Yes

171821 Trailer lighting set

Multi connector: HC-CARGO 171372, 171373. Lens: HC-CARGO 170833. Light: HC-CARGO 171822.

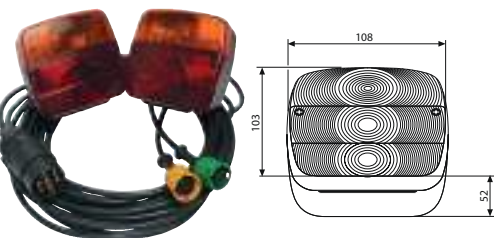

Bulb incl.: Yes
Voltage: 12

Dim.: 108x103x52 mm
Cable length:
2x5000 mm

Shape: Square
Flasher light: w/
Numberplate light: w/
Tail light: w/
Stop light: w/
E-approval: Yes

171872 Trailer lighting set

Lens: HC-CARGO 171833, 171834. Lamp: HC-CARGO 171870, 171871.

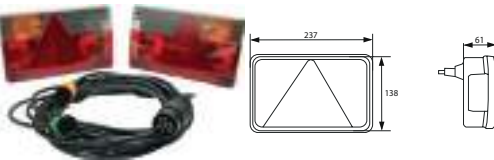

Bulb incl.: Yes
Voltage: 12

Dim.: 237x138x61 mm
Cable length:
2x7500 mm

Shape: Rectangular
No./lamps: 2
Flasher light: w/
Numberplate light: w/
Rear/fog lamp: w/
Tail light: w/
Stop light: w/
E-approval: Yes

171873 Trailer lighting set

Multi connector: HC-CARGO 171372, 171373. Lens: HC-CARGO 170833.

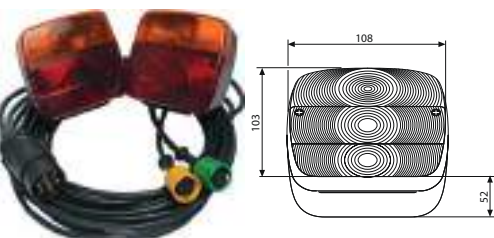

Bulb incl.: Yes
Voltage: 12

Dim.: 108x103x52 mm
Cable length:
2x7500 mm

Shape: Square
Flasher light: w/
Numberplate light: w/
Tail light: w/
Stop light: w/
E-approval: Yes

171935 Trailer Lighting Set

7-pole plug. Magnet w/ metalbracket: HC-CARGO 170942.

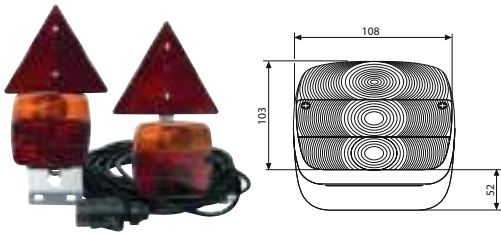

Bulb incl.: Yes
Voltage: 12

Dim.: 108x103x52 mm
Cable length:
4000/13000 mm

Mount.: Magnetic
No./lamps: 2
Flasher light: w/
Tail light: w/
Stop light: w/

SPARE PARTS

170833 Lens, Rear Lamp

Servicing: HC-CARGO 170939, 170940



Dim.: 108x103x52 mm

Material: Shockproof plastic
Flasher light: w/
Tail light: w/
Stop light: w/
RH/LH: RH/LH

170834 Lens, Rear Lamp

Servicing: HC-CARGO 170941



Dim.: 108x103x52 mm

Shape: Rectangular
Fixing screw: 2
Flasher light: w/
Sidemarker: w/

170939 Multi Function Lamp

Servicing: HC-CARGO 170809, 170818, 170828, 170829, 170835, 171049

Lens: HC-CARGO 170833.

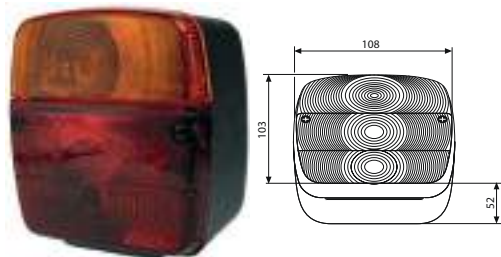

Bulb incl.: No
Watt 1: 21
Watt 2: 21/5

Dim.: 108x103x52 mm
Dist. mount. holes:
45/55 mm

Socket type 1: BA15S
Socket type 2: BAY15d
Material: Shockproof plastic
Fixing screw: 2
Flasher light: w/
Tail light: w/
Stop light: w/
RH/LH: RH/LH
E-approval: Yes

170940 Multi Function Lamp

Servicing: HC-CARGO 170829

Lens: HC-CARGO 170833.

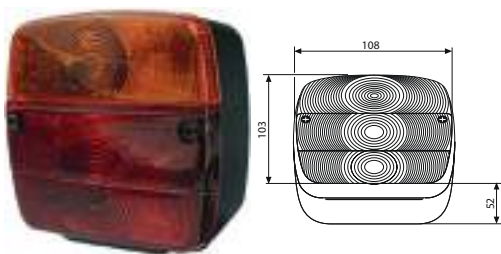

Bulb incl.: No
Watt 1: 21
Watt 2: 21/5

Dim.: 108x103x52 mm
Dist. mount. holes:
45/55 mm

Socket type 1: BA15S
Socket type 2: BAY15d
Material: Shockproof plastic
Fixing screw: 2
Flasher light: w/
Numberplate light: w/
Tail light: w/
Stop light: w/
RH/LH: RH/LH
E-approval: Yes

170941 Flasher/Position Lamp

Servicing: HC-CARGO 170828



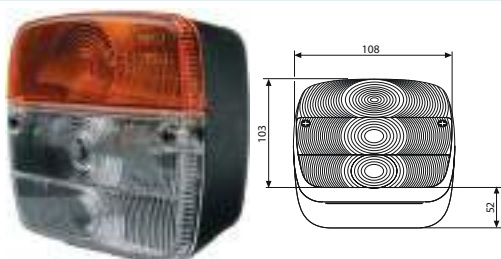

Lens: HC-CARGO 170834.



Bulb incl.: No
Watt 1: 21
Watt 2: 5

Dim.: 108x103x52 mm
Dist. mount. holes:
55 mm

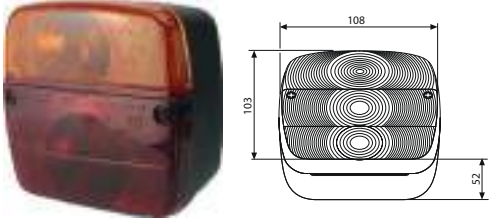
Socket type 1: BA15S
Socket type 2: S8.5
Material: Shockproof plastic
Shape: Rectangular
Fixing screw: 2
Flasher light: w/
Sidemarker: w/
RH/LH: RH/LH
E-approval: Yes

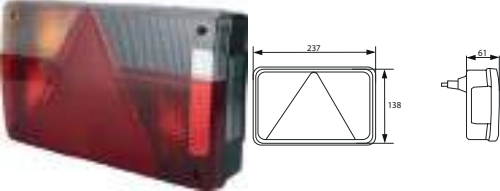
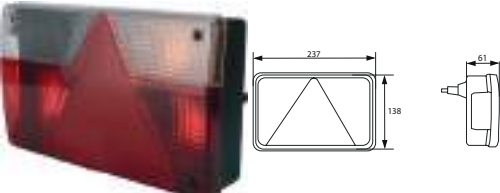
EL. SPECIFICATIONS		DIMENSIONS	ADDITIONAL SPECIFICATIONS
170942 Magnet Servicing: HC-CARGO 170818, 170828			
<i>For camera.</i>			
		OD: 76 mm	
171795 Rubber Protection Servicing: HC-CARGO 170942			
		ID: 76 mm	Rubber: w/
171822 Multi Function Lamp Servicing: HC-CARGO 171821			
<i>Multi connector: HC-CARGO 171372, 171373. Lens: HC-CARGO 170833.</i>			
	Bulb incl.: Yes Watt 1: 21 Watt 2: 21/5	Dim.: 108x103x52 mm Dist. mount. holes: 45/55 mm	Socket type 1: BA15S Socket type 2: BAY15d Shape: Square Flasher light: w/ Sidemarker: w/ Stop light: w/ E-approval: Yes
171833 Lens, Rear Lamp Servicing: HC-CARGO 171818, 171871, 171872			
		Dim.: 237x138x19 mm	Material: Shockproof plastic Shape: Rectangular Flasher light: w/ Numberplate light: w/ Rear/fog lamp: w/ Sidemarker: w/ Stop light: w/ RH/LH: RH E-approval: Yes
171834 Lens, Rear Lamp Servicing: HC-CARGO 171818, 171870, 171872			
		Dim.: 237x138x19 mm	Material: Shockproof plastic Flasher light: w/ Numberplate light: w/ Rear/fog lamp: w/ Sidemarker: w/ Stop light: w/ RH/LH: LH E-approval: Yes
171870 Multi Function Lamp Servicing: HC-CARGO 171818, 171872			
<i>Multi connector: HC-CARGO 171372, 171373. Lens: HC-CARGO 171834. Right: HC-CARGO 171871.</i>			
	Bulb incl.: Yes Voltage: 12	Dim.: 237x138x61 mm	Shape: Rectangular Flasher light: w/ Numberplate light: w/ Rear/fog lamp: w/ Sidemarker: w/ Stop light: w/ RH/LH: LH E-approval: Yes
171871 Multi Function Lamp Servicing: HC-CARGO 171818, 171872			
<i>Multi connector: HC-CARGO 171372, 171373. Lens: HC-CARGO 171833. Left: HC-CARGO 171872.</i>			
	Bulb incl.: Yes Voltage: 12	Dim.: 237x138x61 mm	Shape: Rectangular Flasher light: w/ Numberplate light: w/ Rear/fog lamp: w/ Sidemarker: w/ Stop light: w/ RH/LH: RH E-approval: Yes

REFLECTORS
170142 Reflector
w/ 5 mm bolt.

OD: 60 mm

 Colour: Red
 Material: Plastic
 Shape: Round
 Approvals: I A approval
 E-approval: Yes

170143 Reflector
w/ 5 mm bolt.

OD: 83 mm

 Colour: Red
 Material: Plastic
 Shape: Round
 Approvals: I A approval
 E-approval: Yes

170144 Reflector

 Dim.: 160x160x160 mm
 Dist. mount. holes:
 85 mm

 Colour: Red
 Material: Plastic
 Shape: Triangle
 Mount.: 2 screws
 Approvals: III A approval
 E-approval: Yes

170163 Reflector

 Dim.: 155x135 mm
 Dist. mount. holes:
 70 mm

 Colour: Red
 Material: Plastic
 Shape: Triangle
 Mount.: 2 holes
 Approvals: III A approval
 E-approval: Yes

170165 Reflector

 OD: 60 mm
 Hole size: 4 mm

 Colour: Red
 Material: Plastic
 Shape: Round
 Approvals: I A approval
 E-approval: Yes

170169 Reflector

 OD: 60 mm
 Hole size: 4 mm

 Colour: Orange
 Material: Plastic
 Shape: Round
 Approvals: I A approval
 E-approval: Yes

170170 Reflector

 OD: 60 mm
 Hole size: 4 mm

 Colour: White
 Material: Plastic
 Shape: Round
 Approvals: I A approval
 E-approval: Yes

170212 Reflector
Only approved in DK.



Dim.: 50x200 mm

 Colour: White
 Mount.: Self adhesive
 E-approval: No

170213 Reflector
Only approved in DK.

Dim.: 50x200 mm

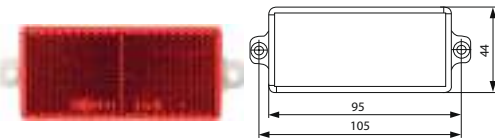
 Colour: Yellow
 Mount.: Self adhesive
 Approvals: JRU
 E-approval: No

170623 Reflector

 Dim.: 95x44 mm
 Dist. mount. holes:
 105 mm

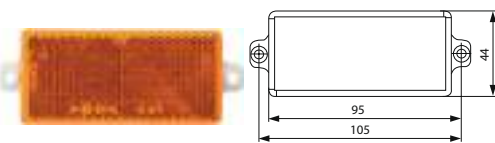
 Colour: Red
 Material: Plastic
 Shape: Rectangular
 Mount.: 2 holes
 Approvals: I A approval
 E-approval: Yes

170624 Reflector

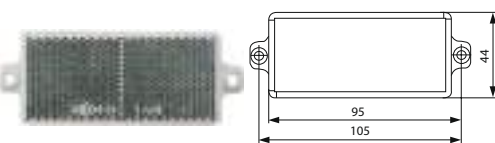
 Dim.: 95x44 mm
 Dist. mount. holes:
 105 mm

 Colour: Orange
 Material: Plastic
 Shape: Rectangular
 Mount.: 2 holes
 Approvals: I A approval
 E-approval: Yes

170625 Reflector

 Dim.: 95x44 mm
 Dist. mount. holes:
 105 mm

 Colour: White
 Material: Plastic
 Shape: Rectangular
 Mount.: 2 holes
 Approvals: I A approval
 E-approval: Yes

170626 Reflector







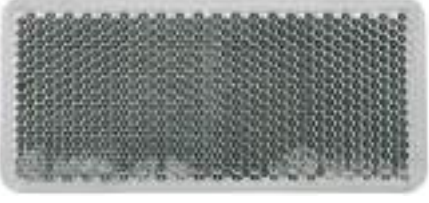

Dim.: 95x44 mm

 Colour: Red
 Material: Plastic
 Shape: Rectangular
 Mount.: Self adhesive
 Approvals: I A approval
 E-approval: Yes

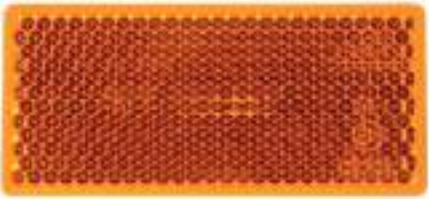
170627 Reflector

Dim.: 95x44 mm

 Colour: Orange
 Material: Plastic
 Shape: Rectangular
 Mount.: Self adhesive
 Approvals: I A approval
 E-approval: Yes

EL. SPECIFICATIONS	DIMENSIONS	ADDITIONAL SPECIFICATIONS
<p>170628 Reflector</p> 	<p>Dim.: 95x44 mm</p>	<p>Colour: White Material: Plastic Shape: Rectangular Mount.: Self adhesive Approvals: I A approval E-approval: Yes</p>
<p>170629 Reflector</p> 	<p>Dim.: 71x35 mm</p>	<p>Colour: Red Material: Plastic Shape: Rectangular Mount.: Self adhesive Approvals: I A approval E-approval: Yes</p>
<p>170630 Reflector</p> 	<p>Dim.: 71x35 mm</p>	<p>Colour: Orange Material: Plastic Shape: Rectangular Mount.: Self adhesive Approvals: I A approval E-approval: Yes</p>
<p>170631 Reflector</p> 	<p>Dim.: 71x35 mm</p>	<p>Colour: White Material: Plastic Shape: Rectangular Mount.: Self adhesive Approvals: I A approval E-approval: Yes</p>
<p>170675 Reflector</p> 	<p>OD: 60 mm</p>	<p>Colour: Red Material: Plastic Shape: Round Mount.: Self adhesive Approvals: I A approval E-approval: Yes</p>
<p>170676 Reflector</p> 	<p>OD: 60 mm</p>	<p>Colour: Orange Material: Plastic Shape: Round Mount.: Self adhesive Approvals: I A approval E-approval: Yes</p>
<p>170677 Reflector</p> 	<p>OD: 60 mm</p>	<p>Colour: White Material: Plastic Shape: Round Mount.: Self adhesive Approvals: I A approval E-approval: Yes</p>

170729 Reflector

 OD: 83 mm
 Hole size: 4 mm

 Colour: Red
 Material: Plastic
 Shape: Round
 Mount.: 1 hole
 Approvals: I A approval
 E-approval: Yes

171228 Reflector

 Dim.: 90x40 mm
 Dist. mount. holes:
 79 mm

 Colour: Red
 Material: Plastic
 Shape: Rectangular
 Mount.: 2 holes
 Approvals: I A approval
 E-approval: Yes

ACCESSORIES
171536 Bracket

ID: 60 mm

No./mounting holes: 1 (0)

CONTAINER MARKING
171895 Skipmarking
Self-adhesive. Left. Class 2.

Dim.: 100x400 mm

 Colour: White/red
 Material: Film
 Shape: Rectangular
 Approvals: No Homogation required

171896 Skipmarking
Self-adhesive. Right. Class 2.

Dim.: 100x400 mm

 Colour: White/red
 Material: Film
 Shape: Rectangular
 Approvals: No Homogation required

171897 Skipmarking
Self-adhesive kit. Class 2.

Dim.: 200x400 mm

 Colour: White/red
 Material: Film
 Shape: Rectangular
 Approvals: No Homogation required

WARNING TRIANGLES

170171 Warning Triangle

Break down warning triangle. Supplied in plastic carrying box.



Shape: Triangle
E-approval: Yes

TRIANGLES

170390 Reflector Triangle

Red: high intensive foil. Class A. Red: fluorenscent foil. w/o bracket.



Dim.: 350-365 mm
Dist. mount. holes:
153 mm

Colour: Red
Material: Aluminium
Shape: Triangle
E-approval: Yes

170759 Reflector Triangle

Red: high intensive foil. Class A. Red: fluorenscent foil. w/o bracket.



Dim.: 428x375x310 mm
Dist. mount. holes:
153 mm
Hole size: 6 mm

Colour: Red
Material: Shock thermo plastic
Shape: Triangle
E-approval: Yes

ACCESSORIES

170391 Mounting Bracket

Servicing: HC-CARGO 170390, 170759

Male.



170392 Mounting Bracket

Servicing: HC-CARGO 170390, 170759

Female.



170393 Mounting Bracket Kit

Servicing: HC-CARGO 170390, 170759

w/ male and female brackets, bolts and nuts.



170797 Mounting Bracket

Servicing: HC-CARGO 170390, 170759

Angled.



HAZARD WARNING LIGHTS

170683 Hazard Warning Lamp

Servicing: Approved for vehicles carrying dangerous goods

Battery: HC-CARGO 200741, 200768.

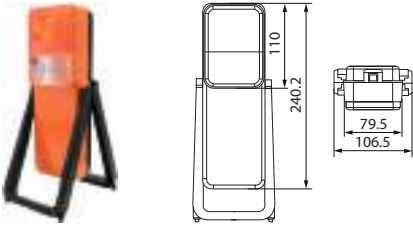

Dim.: 240.2x106.5 mm

Battery type: D
No./batteries: 5
Hazard flasher: w/
Approval: GGVS
E-approval: Yes

LED

171797 LED Hazard Warning Lamp

Battery: HC-CARGO 200739.



Dim.: 215x75x63 mm

Bulb type: LED
Battery type: AA
Material: ABS plastic
No./batteries: 4
Hazard flasher: w/
Drop proof: Yes
Approval: GGVS/ADR

PEN-/TORCH LIGHTS

TORCH LIGHT CONVENTIONAL

170353 High Powered Torch

Bulb: HC-CARGO 171280. Batteries: HC-CARGO 200741, 200768.



Dim.: 182x111 mm

Bulb type: Krypton
Battery type: D
No./batteries: 4
Approval: CE

TORCH LIGHT LED

171749 LED Torch Light

Battery: HC-CARGO 200738.



Watt: 1
Lumen: 65

Dim.: 37x120 mm

Bulb type: LED
Battery type: AAA
Material: Aluminium
No./batteries: 3
Clips: w/
Waterproof: Yes

171787 LED Torch Light

Battery: HC-CARGO 200740.



Watt: 2.2

Dim.: 217x52x52 mm

Bulb type: LED
Battery type: LR14
Material: Shockproof plastic
No./batteries: 3
Shoulder strap: w/
Drop proof: Yes
Waterproof: Yes

PEN-/TORCH LIGHTS LED

171704 LED Penlight

Button w/ easy touch for either signal or constant light. Optical lense intensive the light. At least 8 hours of burn time.



Dim.: 14.5x109 mm

Bulb type: LED
Battery type: AAA
Material: Aluminium
No./batteries: 1
Drop proof: Yes
Waterproof: Yes
Approval: CE

HAND LAMPS CONVENTIONAL

200181 Hand Lamp

Works at temperature below zero. All parts are replaceable. Neon tube HC-CARGO 170664.



Voltage: 230
Watt: 8
Lumen: 400

Length: 510 mm
Cable length: 5 mm

Plug: w/
Hi impact: Yes
Tightness norm: IP 67
Approvals: CE

200635 Hand Lamp

Four times more powerful than conventional hand lamps. Works at temperature below zero. All parts replaceable. Resistant to oil, petrol and chemicals.



Voltage: 230
Watt: 11
Lumen: 900

Length: 455 mm
Cable length: 5 mm

Plug: w/
Hi impact: Yes
Tightness norm: IP 64
Approvals: CE

200728 Hand Lamp

Works at temperature below zero. All parts are replaceable.



Voltage: 230
Watt: 9
Lumen: 400

Length: 390 mm
Cable length: 5 mm

Plug: w/
Hi impact: Yes
Tightness norm: IP 65
Approvals: CE

200733 Hand Lamp



Voltage: 230
Watt: 8
Lumen: 300

Length: 450 mm
Cable length: 5 mm

Plug: w/
Tightness norm: IP 20
Approvals: CE

200837 Hand Lamp



Voltage: 230
Watt: 11
Lumen: 900

Length: 450 mm
Cable length: 5 mm

Hi impact: Yes
Tightness norm: IP 65
Approvals: CE

SPARE PARTS

170960 Fluorescent Tube

Socket PL-S 2P (G23).



Watt: 11/830
Lumen: 900

Length: 214 mm

Approvals: CE

200659 Electronic Part



Servicing: HC-CARGO 200728, 200635

Watt: 230

Tightness norm: IP 65
Approvals: CE

HAND LAMPS LED

171999 LED Hand Lamp



Lumen: 300

Dim.: 270x42x51 mm

Bulb type: LED
Battery type: Li-ion
Magnet holder: Yes
Lamp head: Yes
Rechargeable: Yes
Approval: CE

172000 LED Hand Lamp UK



Lumen: 300

Dim.: 270x42x51 mm

Bulb type: LED
Battery type: Li-ion
Magnet holder: Yes
Lamp head: Yes
Rechargeable: Yes
Approval: CE

BULB HOLDERS

170135 Bulb Holder



Socket type: BAY15d

170136 Bulb Holder



Socket type: BA9s

170137 Bulb Holder



Socket type: BA7s

170138 Bulb Holder



Socket type: BA15S

170139 Bulb Holder

33-36 mm. Festoon type.



Socket type: S8.5

170433 Bulb Holder

Servicing: H4

Also for bulbs that fit socket P45t. Used w/ sealed beams.



Socket type: P43t

170596 Bulb Holder



Socket type: BA15d

170619 Bulb Holder

Servicing: H4

Also for bulbs that fit socket P43t. Used w/ sealed beams.



Socket type: P45t

170763 Bulb Holder

Servicing: VW Golf, Vento, Polo, Passat, Seat Ibiza, Toledo



Socket type: T10

170790 Bulb Holder

2x terminal connection.



Socket type: BA9s

170791 Bulb Holder

2x screw connection.



Socket type: BA15S

170799 Bulb Holder

Servicing: HC-CARGO 191938

Also for bulbs that fit socket P45t. Used w/ sealed beams. Angled type.

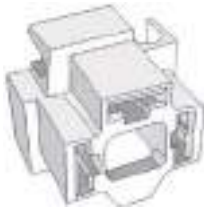

Socket type: P43t

170827 Bulb Holder

2x terminal connection.



Socket type: T10

170964 Bulb Holder

Servicing: H4

Also for bulbs that fit socket P45. Used w/ sealed beams. w/ snap-lock action for cable connection.



Socket type: P43t+P45t

171426 Bulb Holder

w/ wire.



Socket type: HB3, H10, H12

171427 Bulb Holder

w/ wire.

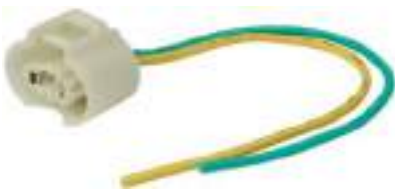

Socket type: HB4

171453 Bulb Holder

H7.



Socket type: PX26d

171783 Bulb Holder



Socket type: HB1, HB5

171784 Bulb Holder		
		Socket type: H8, H9, H11

171924 Bulb Holder <i>H1/H3. 2 way.</i>		
		Socket type: P14.5s, PK22s, PKY22s

171925 Bulb Holder <i>H1/H3. 1 way.</i>		
		Socket type: P14.5s, PK22s, PKY22s

171954 Bulb Holder <i>H4.</i>		
		Socket type: P43t

172072 Bulb Holder		
Servicing: HC-CARGO 171010, 170951, 171953, 170726		Socket type: PGJ13
NEW PRODUCT www.hc-cargo.com		

BULB HOLDER SETS

171281 Bulb Holder Set		
Servicing: H4		
Contains: 1 pcs. HC-CARGO 170619. 3 pcs. HC-CARGO 191200.		
		Socket type: P43t

171282 Bulb Holder Set		
Servicing: H4		
Contains: 1 pcs. HC-CARGO 170799. 3 pcs. HC-CARGO 191938.		
		Socket type: P43t